

# DENTAL CATALOGUE

## **Crown Instruments**

Kronenentferner

Enlève-couronne

Removedor de coronas

Leva corone

## **Laboratory**

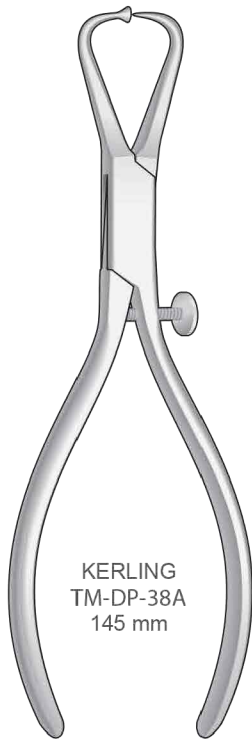
Laboratorium

Laboratoire

Laboratorio

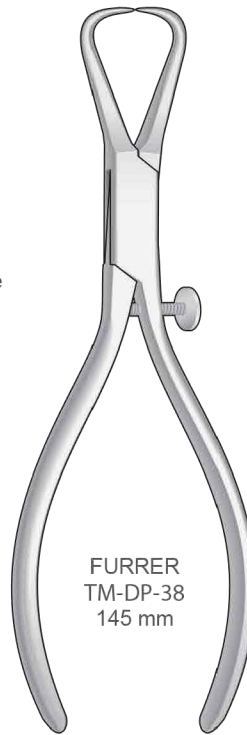
Laboratorio

Kroneninstrumente  
Crown Instruments  
Pinze per corone  
Alicates para coronas  
Pincas pour couronnes

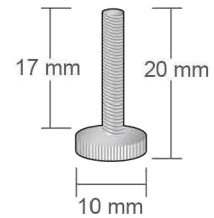


KERLING  
TM-DP-38A  
145 mm

Kupferringabnehmezange  
Copper Ring Removing Pliers  
Pinza per togliere anelli di rame  
Pinza para sacar anillos de cobre  
Pince à enlever les bagues en cuivre

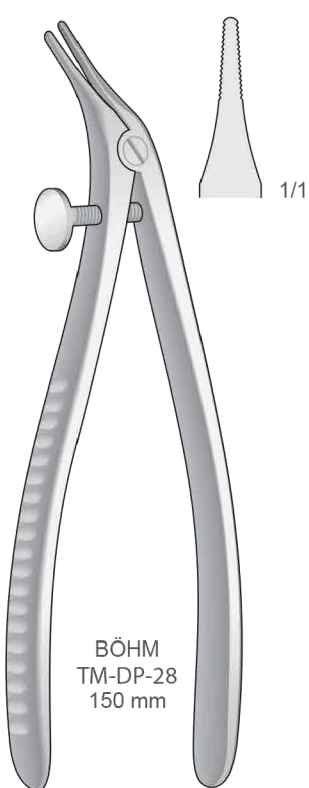


FURRER  
TM-DP-38  
145 mm

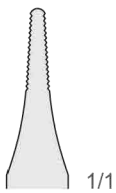


TM-DP-38R  
Schraube  
Replacement Screw  
Vite di ricambio  
Tornillos de recambio  
Vis de rechange

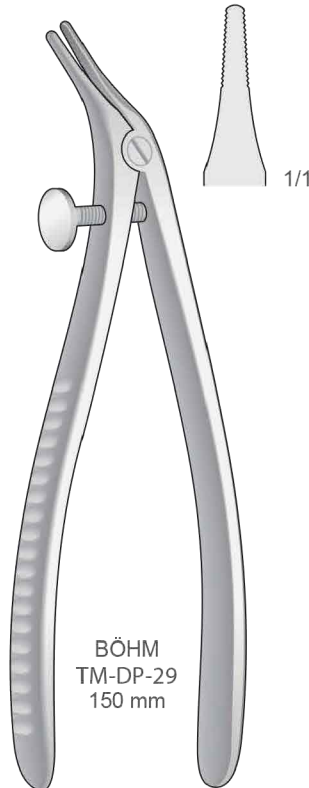
Teleskopkronenzangen - Pliers for telescope crowns  
Pinze per corone telescopiche - Alicates para coronas telescópicas  
Pincas pour couronnes telescopes



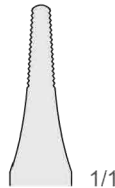
BÖHM  
TM-DP-28  
150 mm



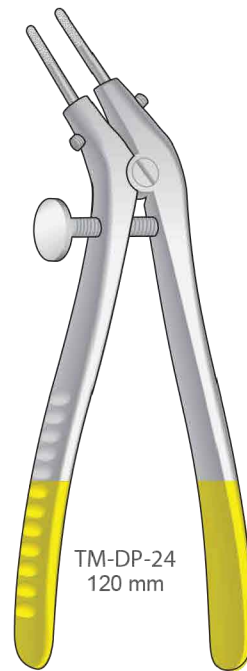
1/1



BÖHM  
TM-DP-29  
150 mm



1/1



TM-DP-24  
120 mm



TM-DP-24C

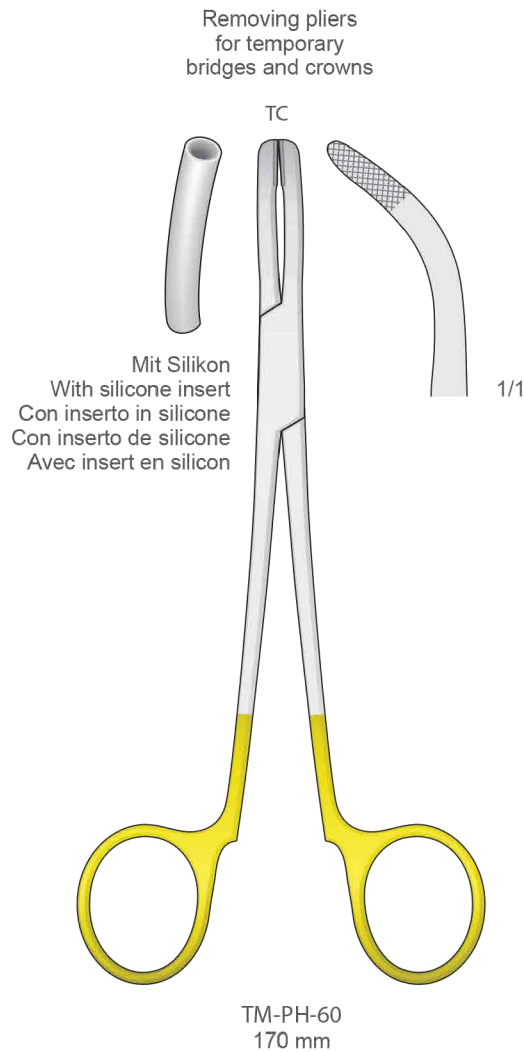
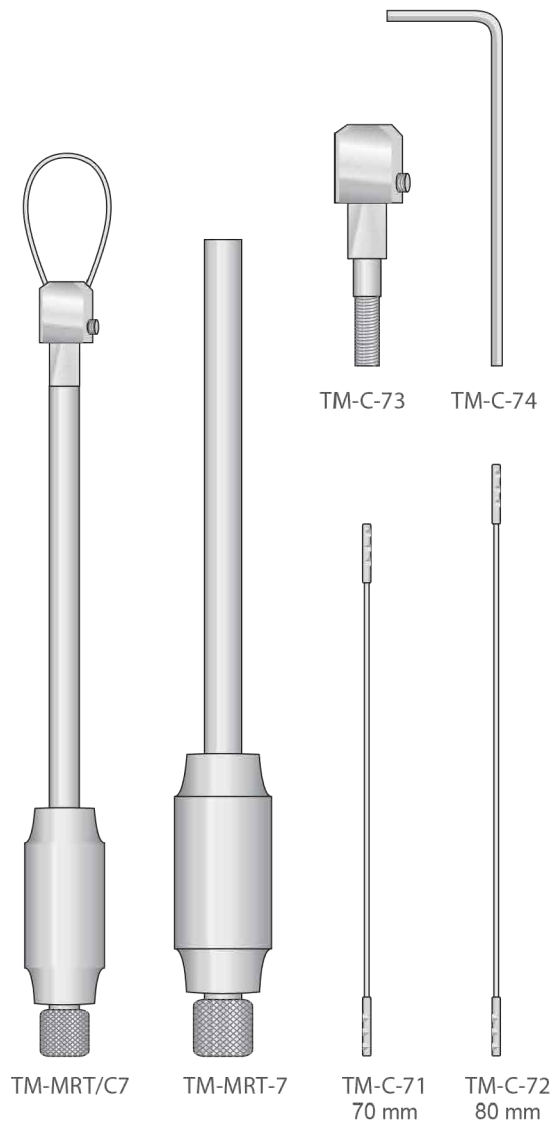
Schlüssel  
Key  
Chiavetta  
Llave  
Clé



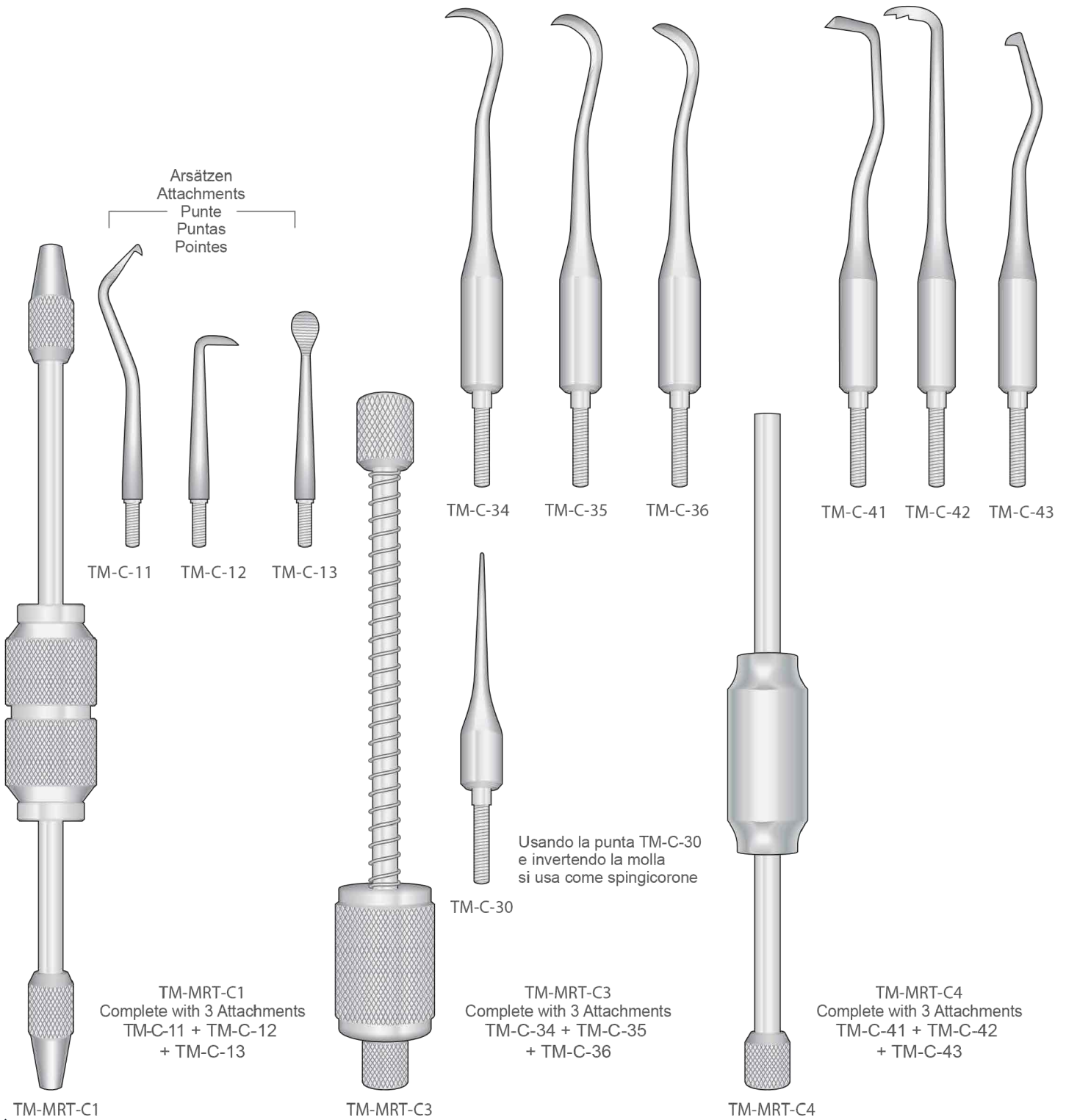
TM-DP-24R

Diamantierte Einsätze, paar  
Diamond inserts, pairs  
Punte diamantate, coppia  
Puntas diamantadas, par  
Pointes diamantées, pair

TM-MRT/C7  
BRIDGE-EXTRACTOR  
COMPLETE SET  
TM-MRT-7 + TM-C-71 + TM-C-72  
+ TM-C-73 + TM-C-74



Kronentferner  
Crown Removers  
Leva corone  
Removedor de coronas  
Enlève-couronne



Kronentferner  
Crown Removers  
Leva corone  
Removedor de coronas  
Enlève-couronne



TM-DL-C  
140 mm



UNIVERSAL  
TM-DL-60  
150 mm

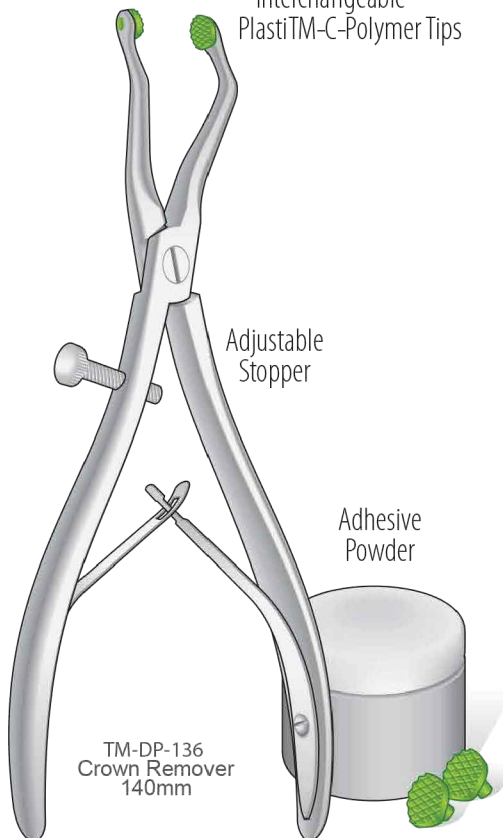


TM-DL-V  
130 mm



TM-DL-0  
130 mm

Interchangeable  
PlastiTM-C-Polymer Tips

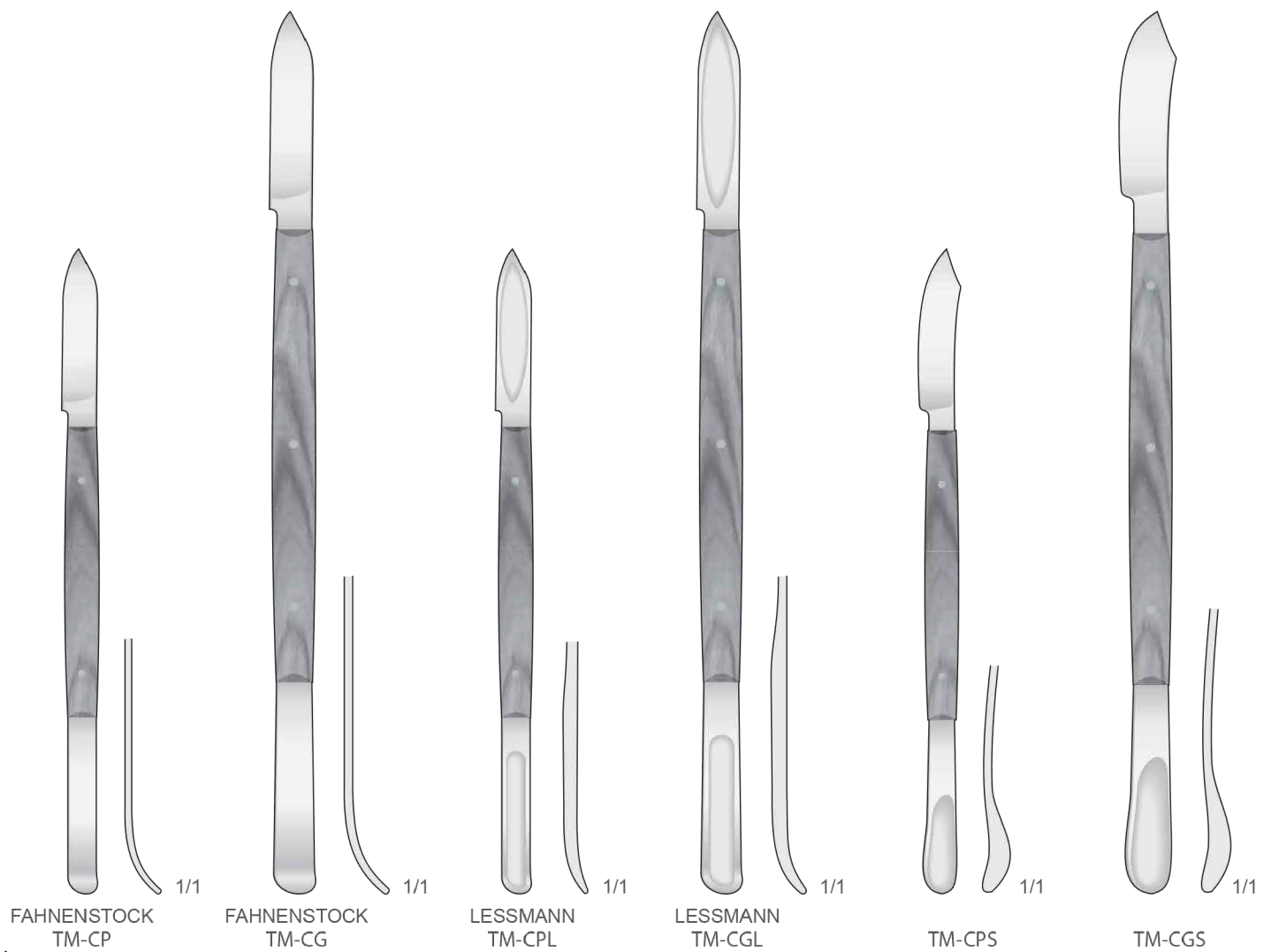


TM-DP-136  
Crown Remover  
140mm

- TM-DP-136  
Crown Remover Set  
1 Crown Remover+ 10 Pairs of PlastiTM-C-Polymer Tips + 10g Adhesive Powder  
Kronentferner Set  
1 Kronenaufweitzange + 10 Paar Kunststoff-Polymer-Tipps + 10g Pulverkleber  
Set Enlève-Couronne  
1 Pince à détacher les couronnes + 10 Paires de pointes de polymère plastique + 10g Adhésif en poudre  
Set Removedor de Coronas  
1 Pinza para quitar coronas + 10 Pares de puntas de polímero plástico+ 10g Polvo adhesivo  
Set Leva Corone  
1 Pinza per corone + 10 Coppie di inserti in plastica + 10 g Polvere adesiva

- TM-DP-137  
Replacement Kit: 10 Pairs of PlastiTM-C-Polymer Tips + 10g Adhesive Powder  
Ersatz-Kit: 10 Paar Kunststoff-Polymer-Tipps + 10g Pulverkleber  
Kit de rechange: 10 Paires de pointes de polymère plastique + 10g Adhésif en poudre  
Kit di ricambio: 10 Pares de puntas de polímero plástico+ 10g Polvo adhesivo  
Kit di ricambio: 10 Coppie di inserti in plastica + 10 g Polvere adesiva

Wachsmesser  
Wax Knives  
Coltelli per cera  
Cuchillos para cera  
Couteaux à cire



Spatulas for plaster and alginate  
Spatole per alginato e gesso

Flexible  
Flexibel  
Flexible  
Flexible  
Flessibile

Rigid  
Fest  
Rigide  
Rígido  
Rigido



GRITMAN  
TM-CM  
175 mm



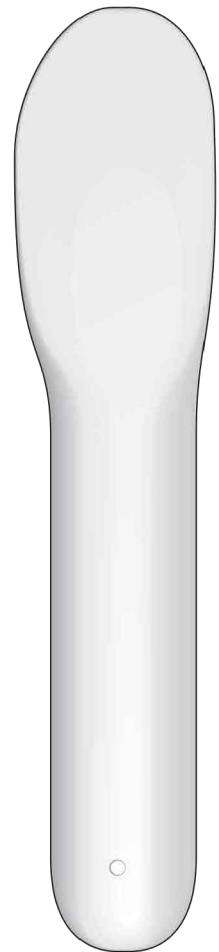
TM-SA-1  
200 mm



TM-SA-2  
200 mm

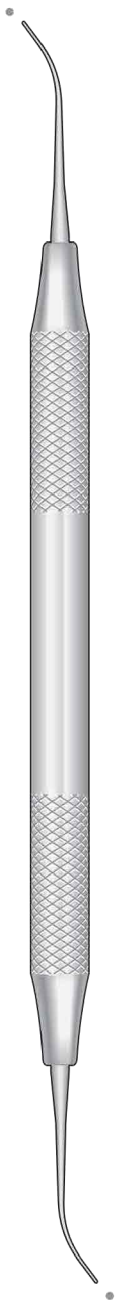


TM-SA-3  
200 mm

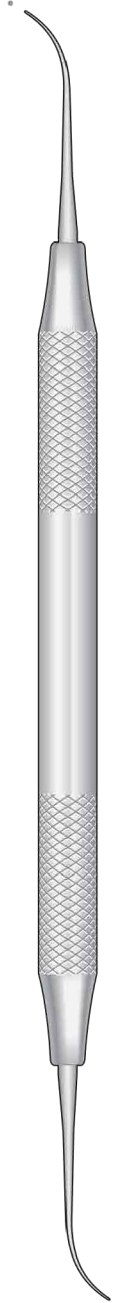


TM-S18-8  
185 mm

Instrumente für Laboratorium  
 Instruments for laboratory  
 Strumenti da laboratorio  
 Instrumentos para laboratorio  
 Instruments pour laboratoire



P.K. THOMAS  
 TM-751-121  
 165 mm

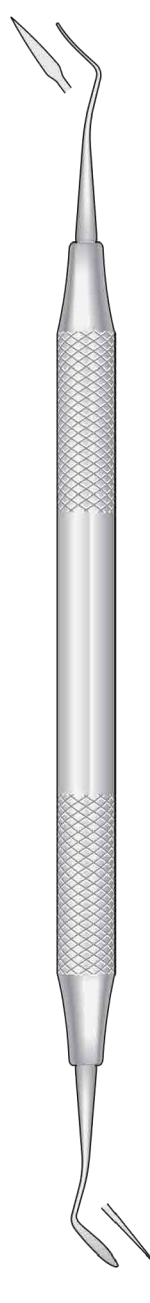


P.K. THOMAS  
 TM-751-122  
 165 mm

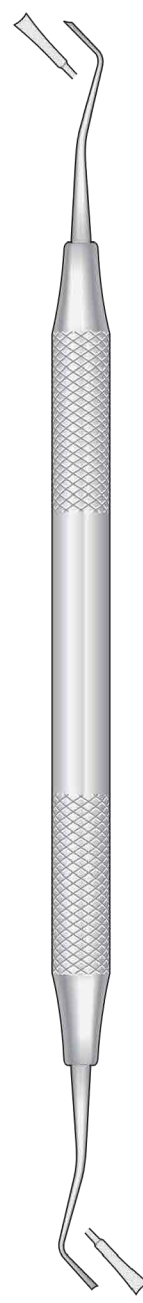


P.K. THOMAS  
 TM-751-123  
 165 mm

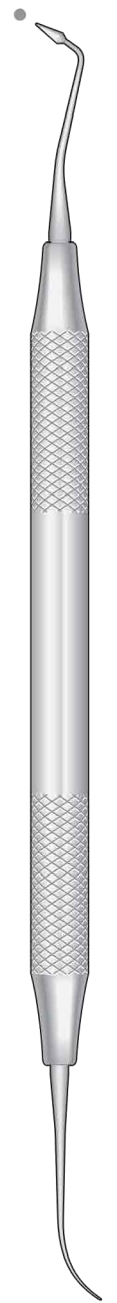
Ø 8 mm  
**Hollow**  
 Hohl  
 Creux  
 Hueco  
 Vuoto



P.K. THOMAS  
 TM-751-124  
 165 mm

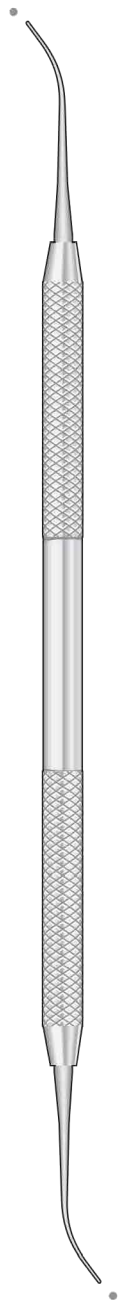


P.K. THOMAS  
 TM-751-125  
 165 mm

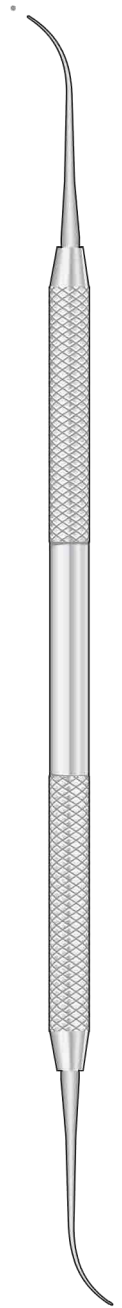


P.K. THOMAS  
 TM-751-2/3  
 165 mm

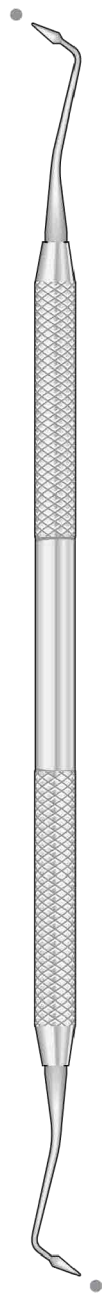




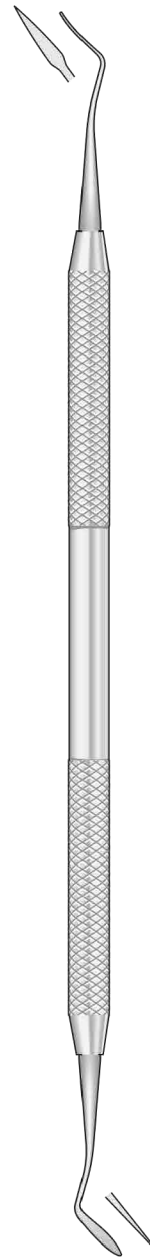
P.K. THOMAS  
TM-PT-1  
165 mm



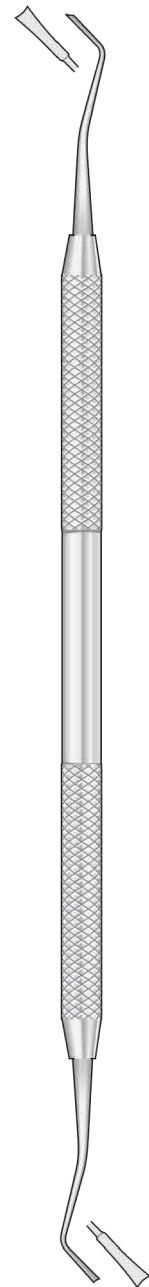
P.K. THOMAS  
TM-PT-2  
165 mm



P.K. THOMAS  
TM-PT-3  
165 mm



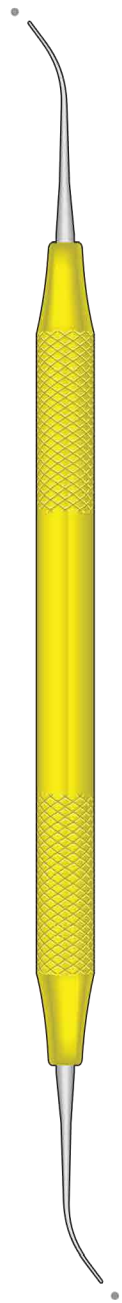
P.K. THOMAS  
TM-PT-4  
165 mm



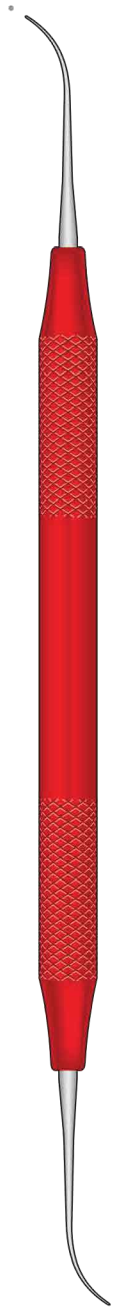
P.K. THOMAS  
TM-PT-5  
165 mm

Instrumente für Laboratorium  
Instruments for laboratory  
Strumenti da laboratorio  
Instrumentos para laboratorio  
Instruments pour laboratoire

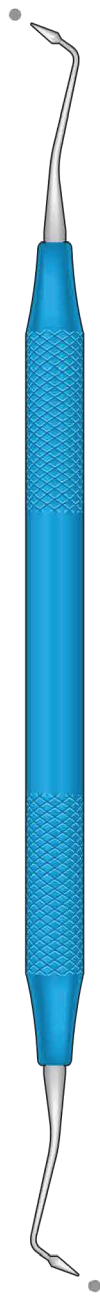
**Aluminium**  
Aluminium  
Aluminium  
Aluminio  
Alluminio



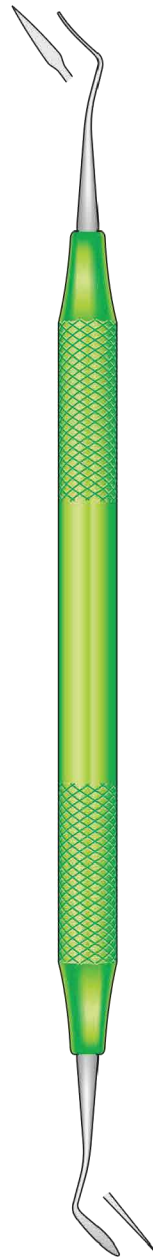
P.K. THOMAS  
TM-AL-PT1  
165 mm



P.K. THOMAS  
TM-AL-PT2  
165 mm



P.K. THOMAS  
TM-AL-PT3  
165 mm



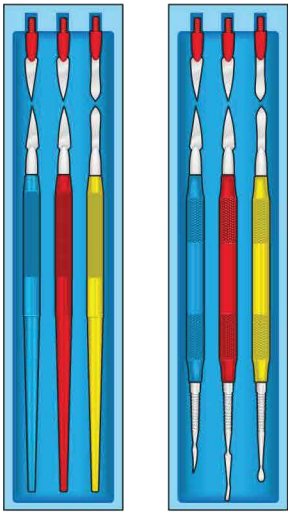
P.K. THOMAS  
TM-AL-PT4  
165 mm



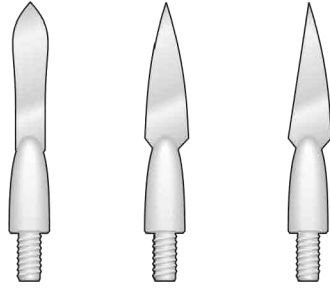
P.K. THOMAS  
TM-AL-PT5  
165 mm

Ø 8 mm  
**Hollow**  
Hohl  
Creux  
Hueco  
Vuoto

Modellierinstrumente für Keramik  
Ceramic Sculpturing Instruments  
Strumenti per ceramica  
Instrumentos para modelar la cerámica  
Instruments à modeler la céramique

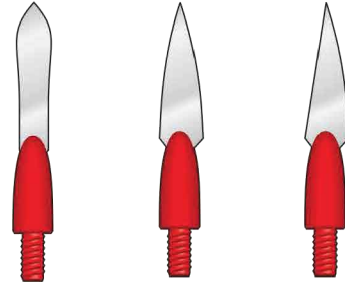


Biegsam - Flexible  
Flessibili - Flexibles  
Flexibles



TM-CL-1B TM-CL-2B TM-CL-3B

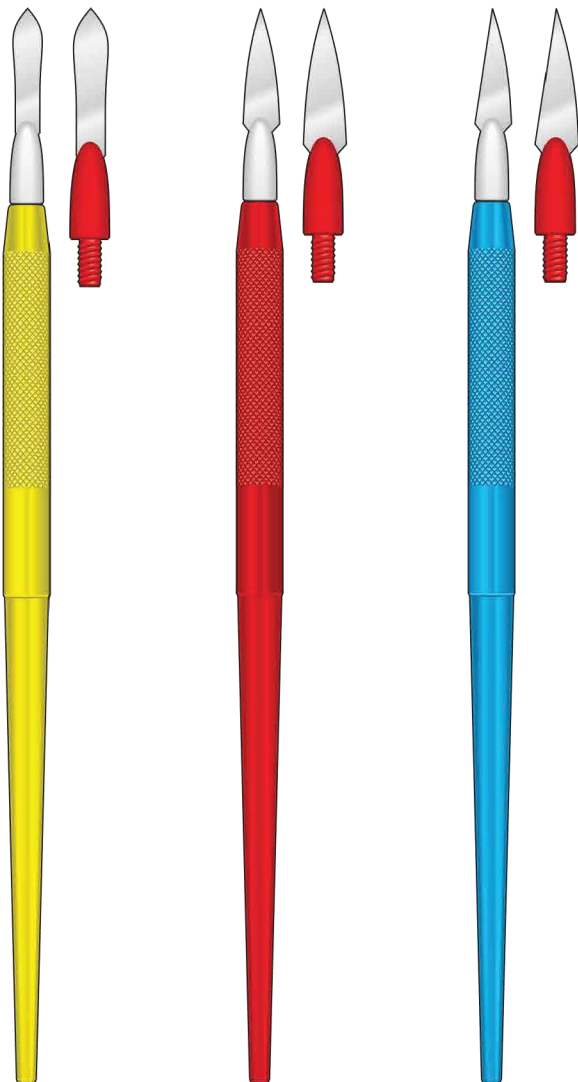
Superbiegsam - Superflexible  
Superflessibili - Superflexibles  
Superflexibles



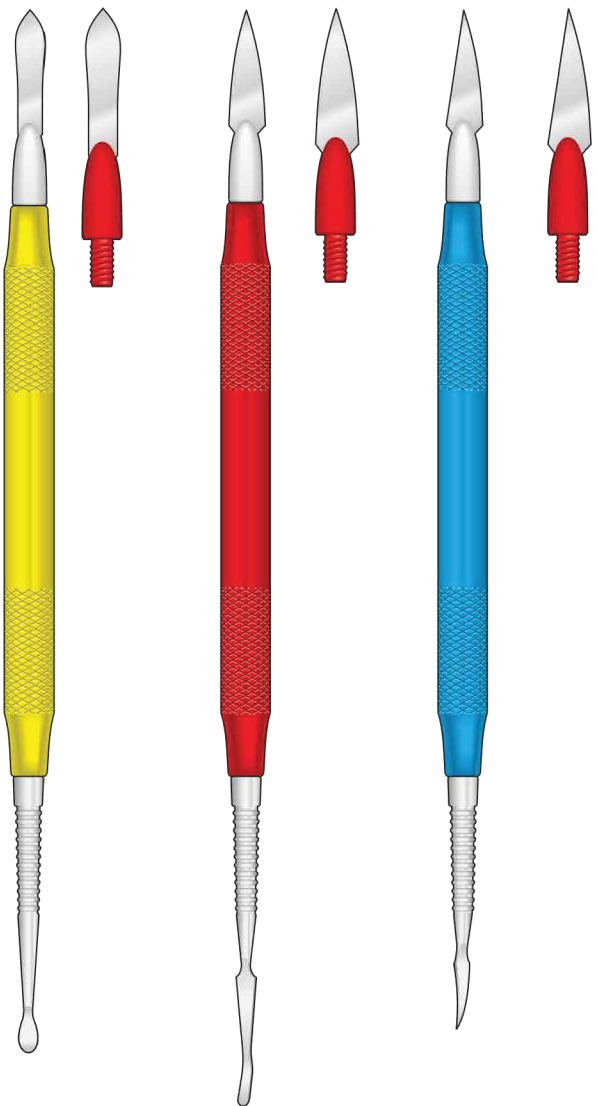
TM-CL-1R TM-CL-2R TM-CL-3R

**Aluminium**  
Aluminium  
Aluminium  
Aluminio  
Alluminio

TM-AL-SETC/1



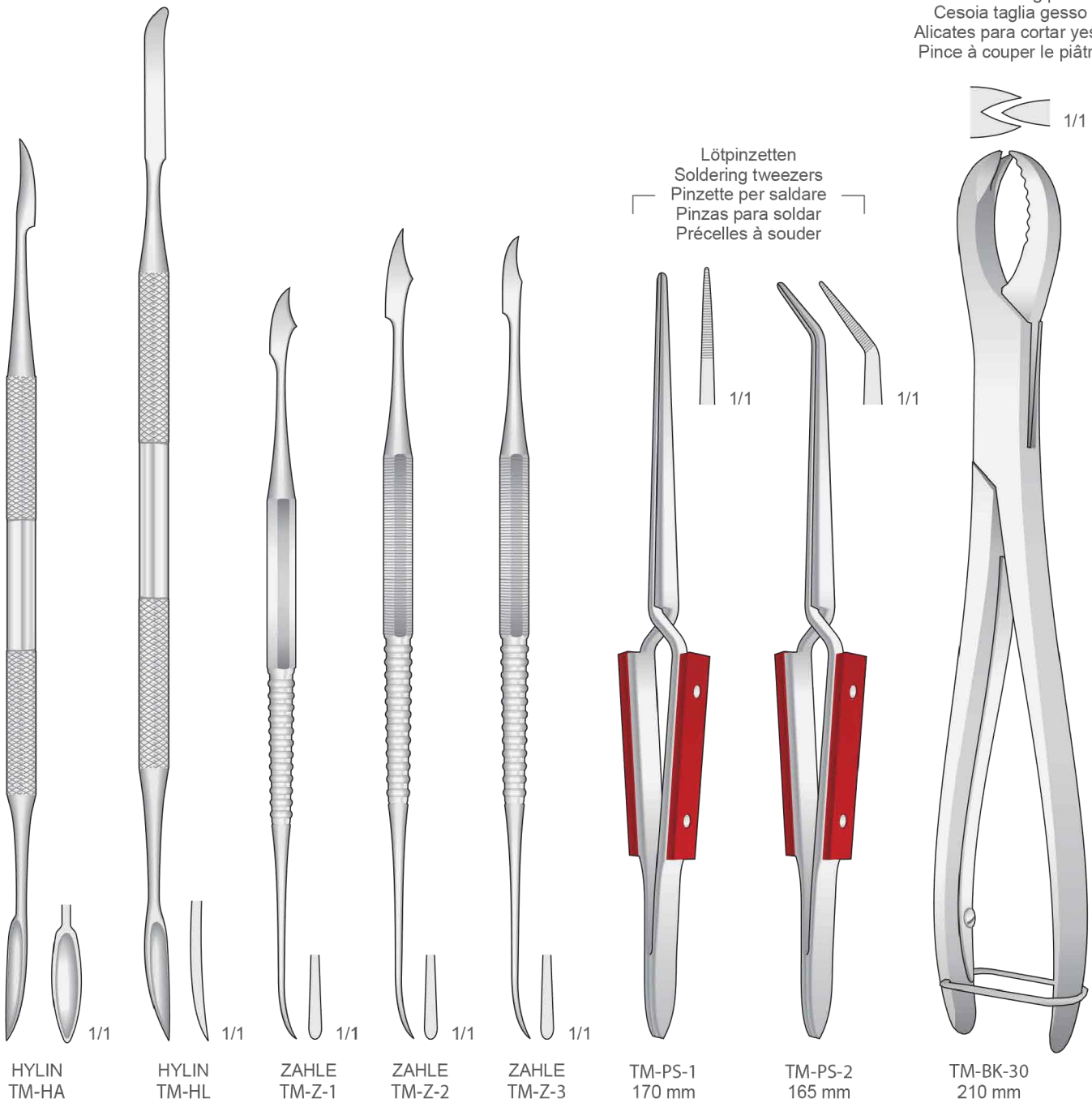
TM-AL-SETC/2



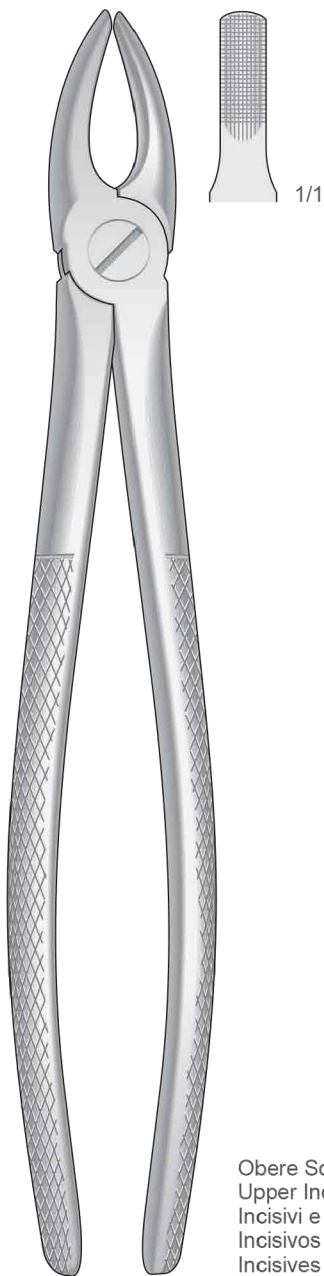


Instrumente für Laboratorium  
Instruments for laboratory  
Strumenti da laboratorio  
Instrumentos para laboratorio  
Instruments pour laboratoire

Gippschneidezange  
Plaster cutting pliers  
Cesoia taglia gesso  
Alicates para cortar yeso  
Pince à couper le piâtre

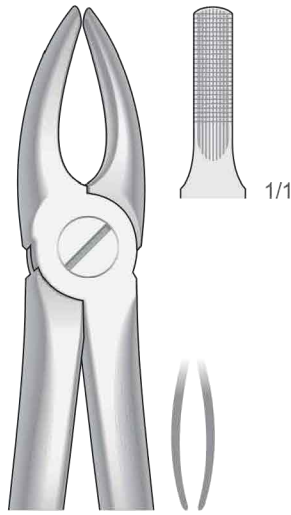


Zahnzangen, Englische Form  
Extracting Forceps, English Pattern  
Pinze per estrazione, Forma Inglese  
Pinzas da extracción, Forma Inglesa  
Daviers, Forme Anglaise



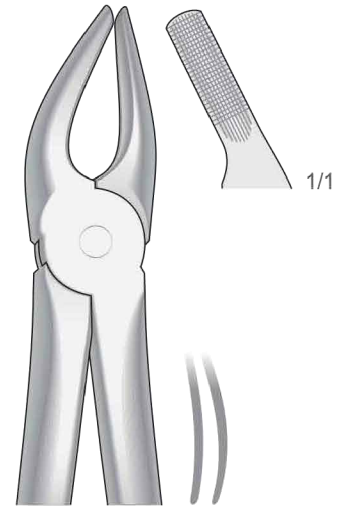
1  
Fig. 1

Obere Schneide- und Eckzähne  
Upper Incisors and cuspids  
Incisivi e canini superiori  
Incisivos y caninos superiores  
Incisives et canines supérieures



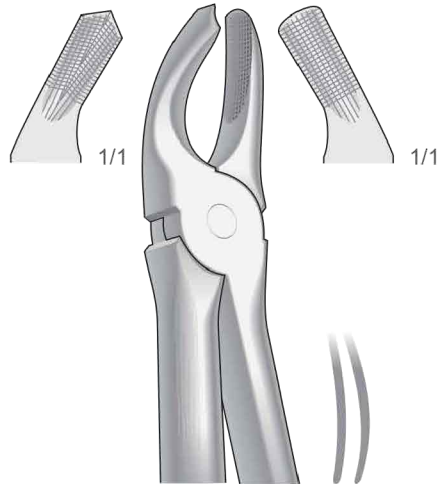
TM-2  
Fig. 2

Obere Schneide- und Eckzähne  
Upper Incisors and cuspids  
Incisivi e canini superiori  
Incisivos y caninos superiores  
Incisives et canines supérieures



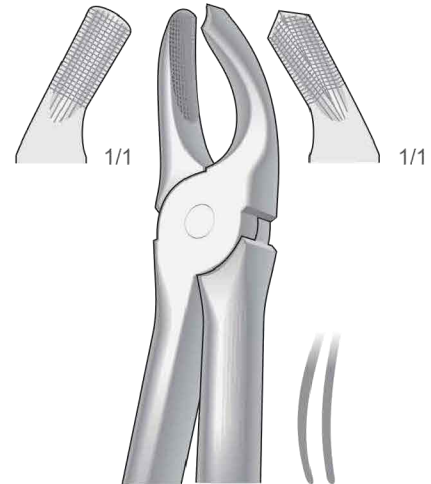
TM-7  
Fig. 7

Obere Prämolaren  
Upper premolars  
Premolari superiori  
Premolares superiores  
Prémolaires supérieures



TM-17  
Fig. 17

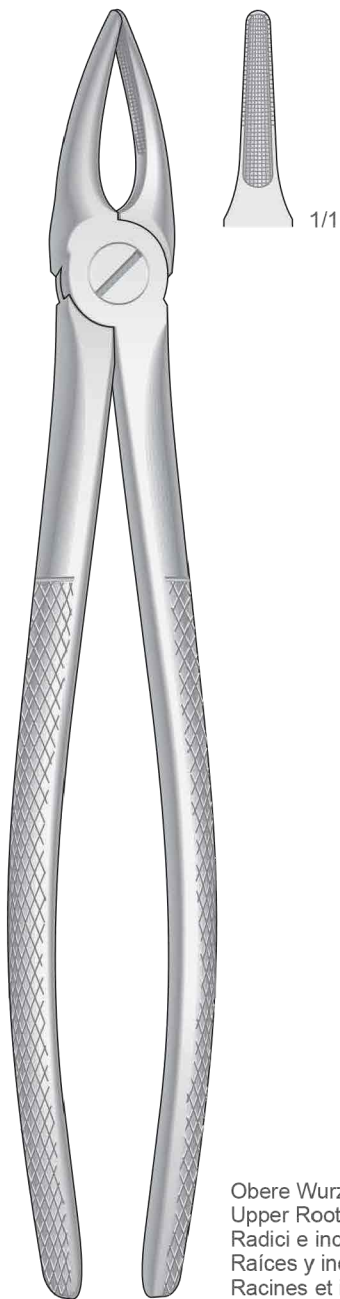
Obere Molaren, rechts  
Upper molars, right  
Molari superiori, destra  
Molares superiores, derechos  
Molaires supérieures, droites



TM-18  
Fig. 18

Obere Molaren, links  
Upper molars, left  
Molari superiori, sinistra  
Molares superiores, izquierdos  
Molaires supérieures, gauches

Zahnzangen, Englische Form  
Extracting Forceps, English Pattern  
Pinze per estrazione, Forma Inglese  
Pinzas da extracción, Forma Inglesa  
Daviers, Forme Anglaise



Obere Wurzeln und Schneidezähne  
Upper Roots and incisors  
Radici e incisivi superiori  
Raíces y incisivos superiores  
Racines et incisives supérieures

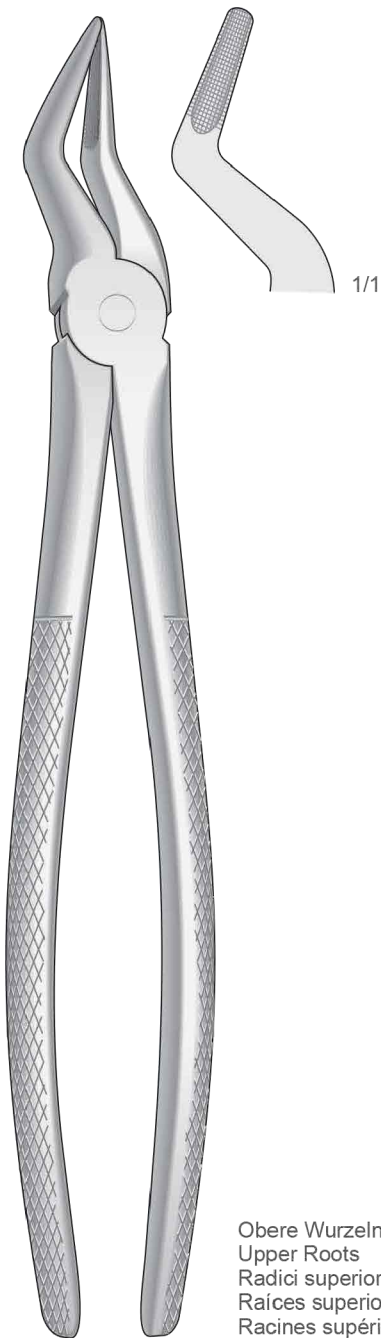
TM-29  
Fig. 29



Obere Wurzeln  
Upper Roots  
Radici superiori  
Raíces superiores  
Racines supérieures

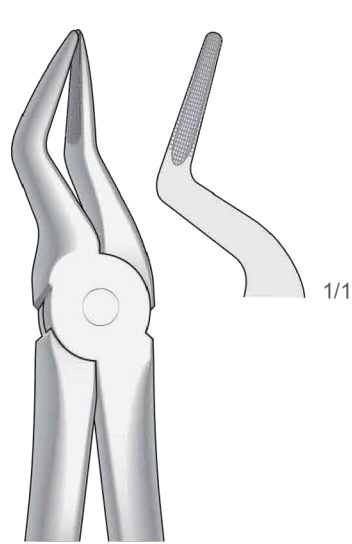
TM-30  
Fig. 30

Zahnzangen, Englische Form  
Extracting Forceps, English Pattern  
Pinze per estrazione, Forma Inglese  
Pinzas da extracción, Forma Inglesa  
Daviers, Forme Anglaise



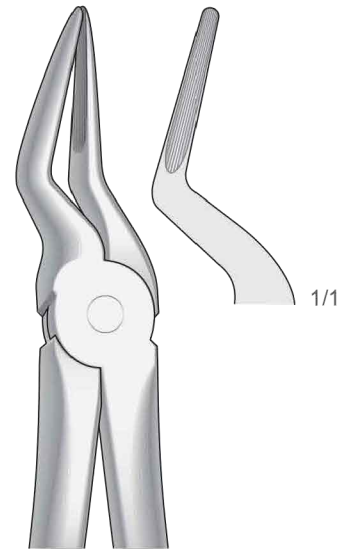
TM-51  
Fig. TM-51

Obere Wurzeln  
Upper Roots  
Radici superiori  
Raíces superiores  
Racines supérieures



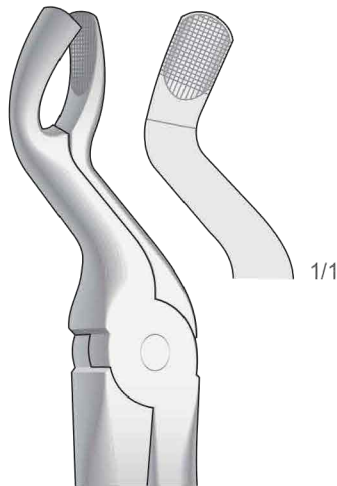
TM-51A  
Fig. TM-51A

Obere Wurzeln  
Upper Roots  
Radici superiori  
Raíces superiores  
Racines supérieures



TM-51L  
Fig. TM-51AL

Obere Wurzeln  
Upper Roots  
Radici superiori  
Raíces superiores  
Racines supérieures

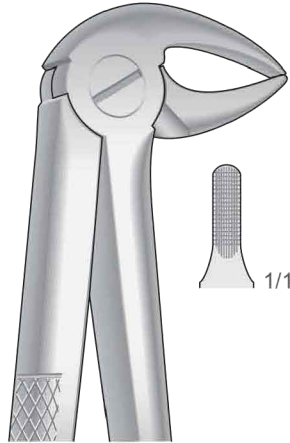


67A  
Fig. 67A

Obere Dritte Molaren - Für Obere Weisheitszähne  
Upper molars - For Upper wisdom teeth  
Ottavi superiori - Per denti del giudizio superiori  
Molares superiores - Para muelas del juicio superiores  
Molaires supérieures - Pour dents de sagesse supérieures

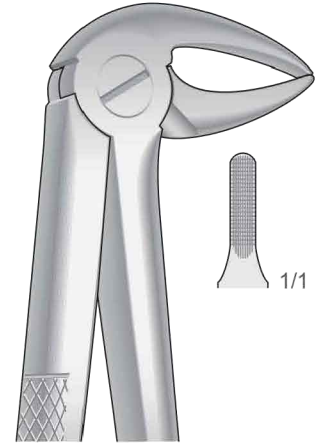


Zahnzangen, Englische Form  
Extracting Forceps, English Pattern  
Pinze per estrazione, Forma Inglese  
Pinzas da extracción, Forma Inglesa  
Daviers, Forme Anglaise



TM-33  
Fig. 33

Untere Prämolaren, Schneidezähne und Wurzeln  
Lower incisors, premolars and roots  
Incisivi, premolari e radici inferiori  
Incisivos, premolares y raíces inferiores  
Incisives, prémolaires et racines inférieures



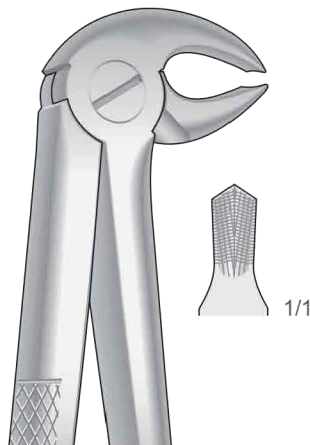
TM-33A  
Fig. 33A

Untere Wurzeln, schlankes Maul  
Lower roots, Slender jaw  
Radici inferiori, morso stretto  
Raíces inferiores, boca estrecha  
Racines inférieures, avec un bec très fin



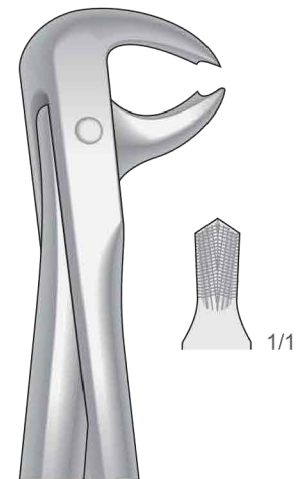
TM-13

Untere Eckzähne und Prämolaren  
Lower cuspids and premolars  
Canini e premolari inferiori  
Caninos y premolares inferiores  
Canines et prémolaires inférieures



TM-22  
Fig. 22

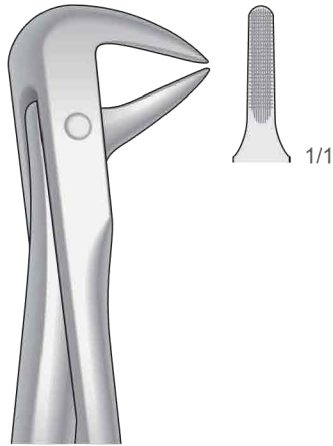
Untere Molaren  
Lower molars  
Molari inferiori  
Molares inferiores  
Molaires inférieures



TM-73  
Fig. 73

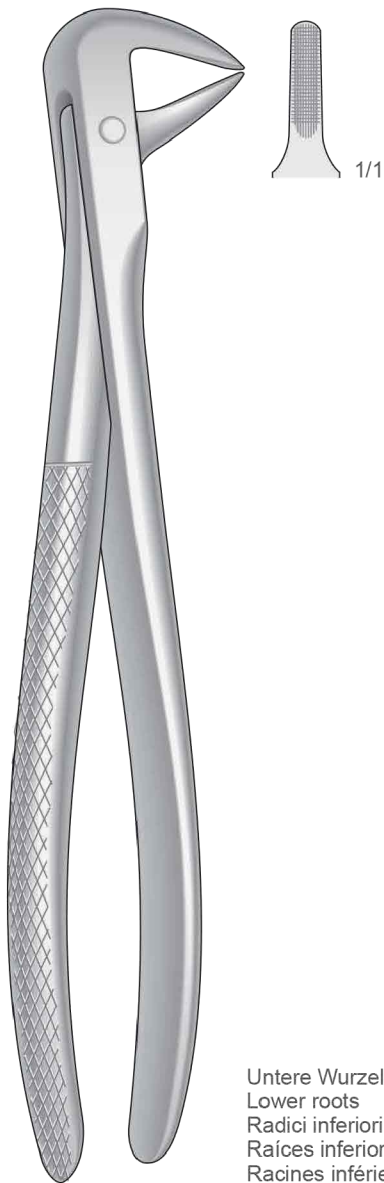
Untere Molaren  
Lower molars  
Molari inferiori  
Molares inferiores  
Molaires inférieures

Zahnzangen, Englische Form  
Extracting Forceps, English Pattern  
Pinze per estrazione, Forma Inglese  
Pinzas da extracción, Forma Inglesa  
Daviers, Forme Anglaise



TM-74N  
Fig. 74N

Untere Wurzeln, schneide-und Eckzähne  
Lower roots, Incisors and bicuspid  
Radici, incisivi e canini inferiori  
Raíces, incisivos y caninos inferiores  
Racines, incisives et canines inférieures



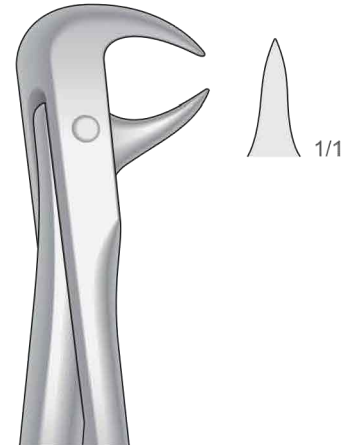
TM-74  
Fig. 74

Untere Wurzeln  
Lower roots  
Radici inferiori  
Raíces inferiores  
Racines inférieures



TM-75  
Fig. 75

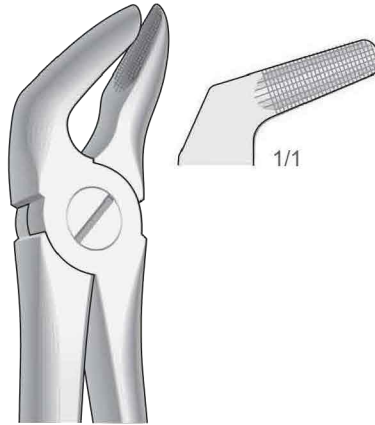
Untere Eckzähne und Prämolaren  
Lower Cuspids and bicuspid  
Canini e premolari inferiori  
Caninos y premolares inferiores  
Canines et prémolaires inférieures



TM-86A  
Fig. 86A

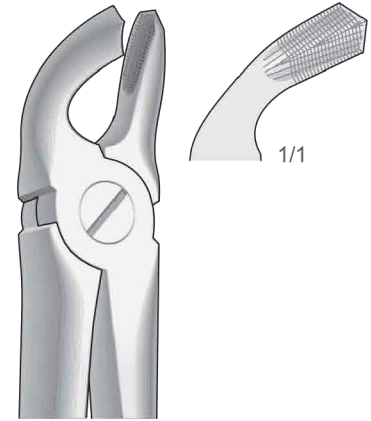
Untere Molaren  
Lower molars  
Molari inferiori  
Molares inferiores  
Molaires inférieures

Zahnzangen, Englische Form  
Extracting Forceps, English Pattern  
Pinze per estrazione, Forma Inglese  
Pinzas da extracción, Forma Inglesa  
Daviers, Forme Anglaise



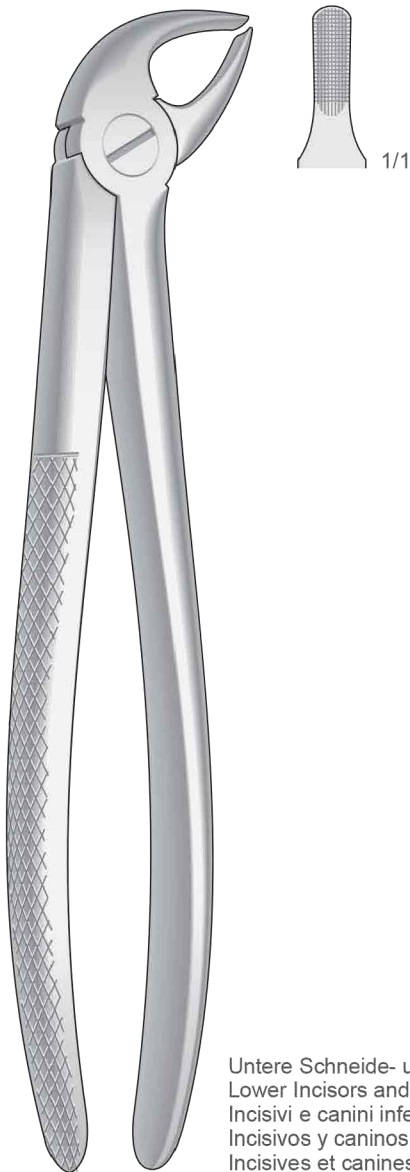
TM-8  
Fig. 8

Untere Prämolaren  
Lower premolars  
Premolari inferiori  
Premolares inferiores  
Prémolaires inférieures



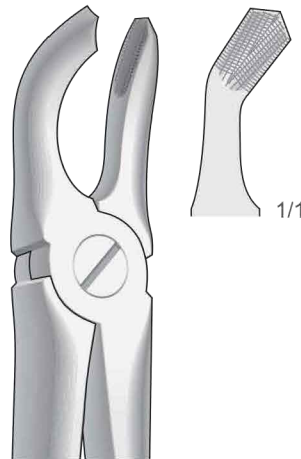
TM-21  
Fig. 21

Untere Weisheitszähne und Molaren  
Lower wisdom teeth and molars  
Denti del giudizio e molari inferiori  
Muelas del juicio y Molares inferiores  
Dents de sagesse et molaires inférieures



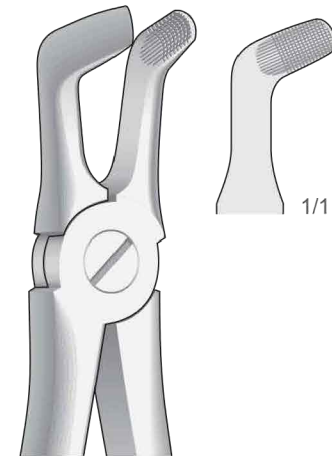
TM-4  
Fig. 4

Untere Schneide- und Eckzähne  
Lower Incisors and cuspids  
Incisivi e canini inferiori  
Incisivos y caninos inferiores  
Incisives et canines inférieures



TM-79  
Fig. 79

Untere Weisheitszähne  
Lower wisdom teeth  
Denti del giudizio inferiori  
Muelas del juicio inferiores  
Dent de sagesse inférieures



TM-79A  
Fig. 79A

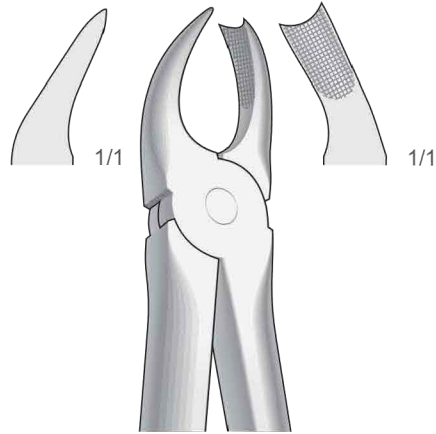
Untere Molaren und Weisheitszähne  
Lower molars and wisdom teeth  
Molari e denti del giudizio inferiori  
Molares y muelas del juicio inferiores  
Molaires et dent de sagesse inférieures

Zahnzangen, Englische Form  
Extracting Forceps, English Pattern  
Pinze per estrazione, Forma Inglese  
Pinzas da extracción, Forma Inglesa  
Daviers, Forme Anglaise



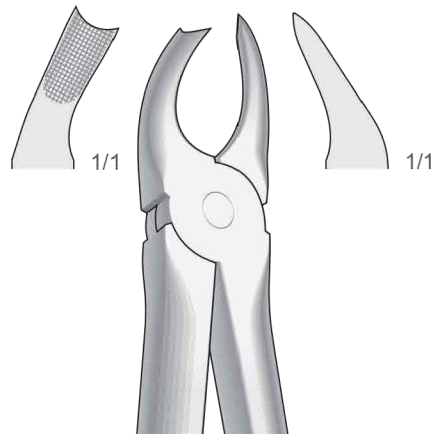
TM-87  
Fig. 87

Untere Molaren  
Lower molars  
Molari inferiori  
Molares inferiores  
Molaires inférieures



TM-89  
Fig. 89

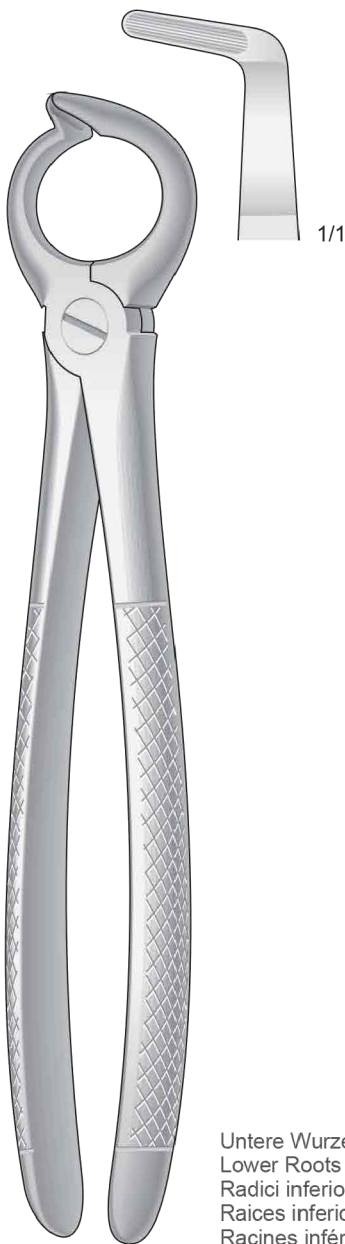
Obere Molaren, rechts  
Upper molars, right  
Molari superiori, destra  
Molares superiores, derechos  
Molaires supérieures, droites



TM-90  
Fig. 90

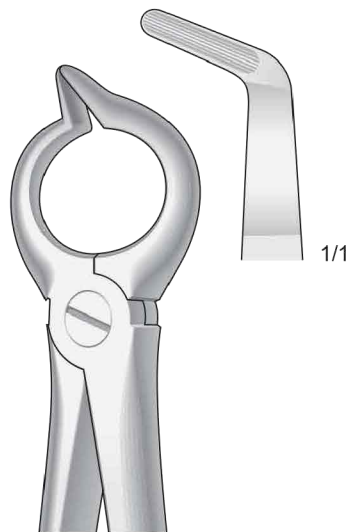
Obere Molaren, links  
Upper molars, left  
Molari superiori, sinistra  
Molares superiores, izquierdos  
Molaires supérieures, gauches

Zahnzangen, Englische Form  
Extracting Forceps, English Pattern  
Pinze per estrazione, Forma Inglese  
Pinzas da extracción, Forma Inglesa  
Daviers, Forme Anglaise



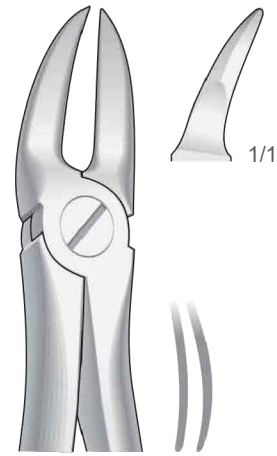
TM-68  
Fig. 68

Untere Wurzeln  
Lower Roots  
Radici inferiori  
Raices inferiores  
Racines inférieures



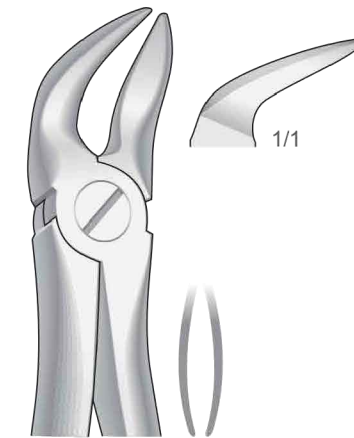
TM-68A  
Fig. 68A

Untere Wurzeln  
Lower Roots  
Radici inferiori  
Raices inferiores  
Racines inférieures



TM-55  
Fig. 55

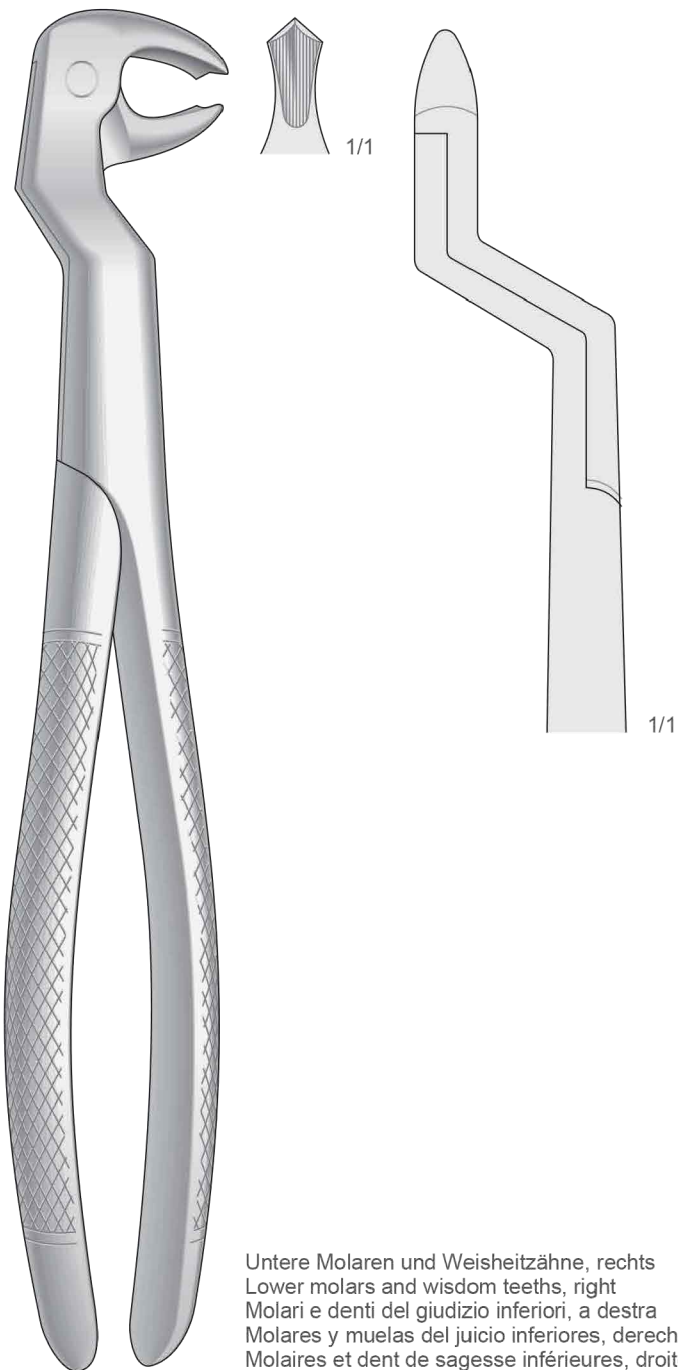
Zum Trennen oberer Molarenwurzeln  
For separating upper molar roots  
Per radici dei molari superiori, presa in profondità  
Para partir raices de molares superiores, profundo  
Pour séparer les racines des molaires supérieures



TM-56  
Fig. 56

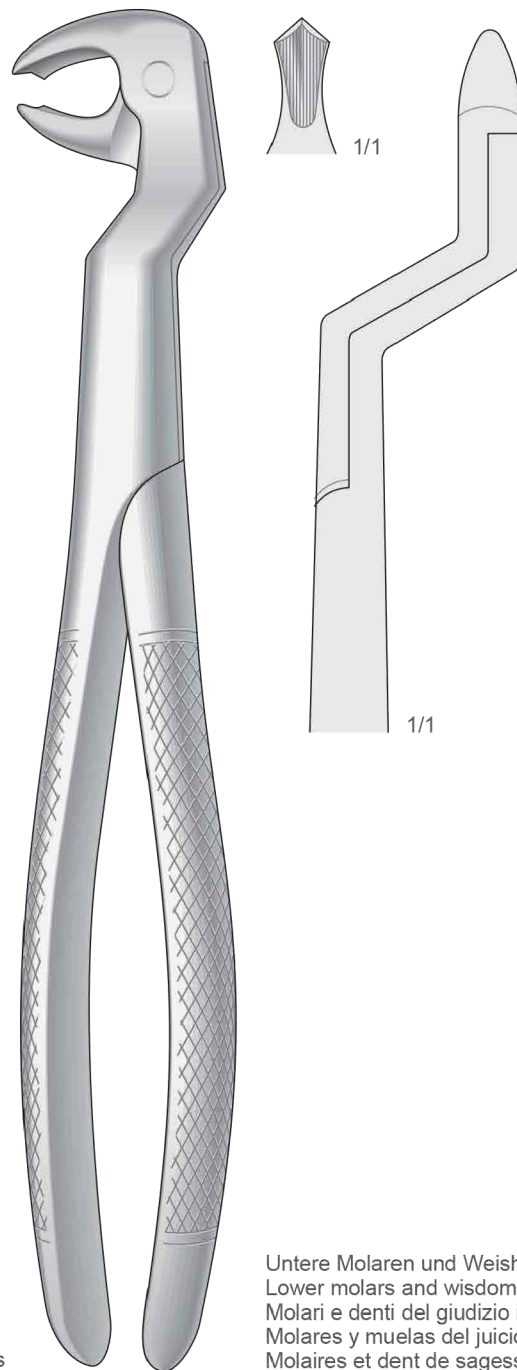
Zum Trennen Unterer Molarenwurzeln  
For separating lower molar roots  
Per radici dei molari inferiori, presa in profondità  
Para partir raices de molares inferiores, profundo  
Pour séparer les racines des molaires inférieures

Zahnzangen, Englische Form  
Extracting Forceps, English Pattern  
Pinze per estrazione, Forma Inglese  
Pinzas da extracción, Forma Inglesa  
Daviers, Forme Anglaise



Untere Molaren und Weisheitszähne, rechts  
Lower molars and wisdom teeth, right  
Molari e denti del giudizio inferiori, a destra  
Molares y muelas del juicio inferiores, derecha  
Molaires et dent de sagesse inférieures, droites

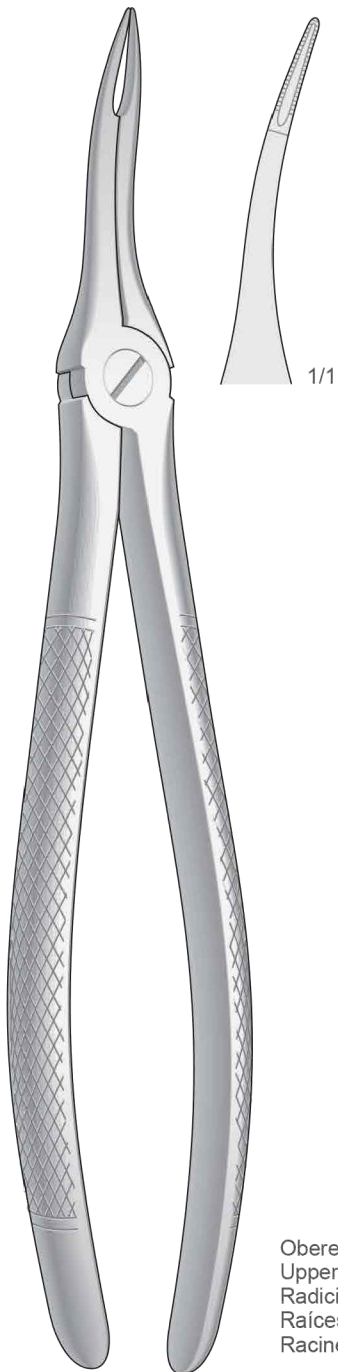
ROUTURIER  
TM-22 1/2 R



Untere Molaren und Weisheitszähne, links  
Lower molars and wisdom teeth, left  
Molari e denti del giudizio inferiori, a sinistra  
Molares y muelas del juicio inferiores, izquierda  
Molaires et dent de sagesse inférieures, gauches

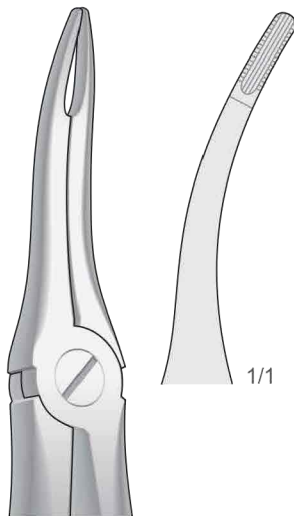
ROUTURIER  
TM-22 1/2 L

Daviers, Forme Anglaise  
Pinzas da extracción, Forma Inglesa  
Pinze per estrazione, Forma Inglese  
Extracting Forceps, English Pattern  
Zahnzangen, Englische Form



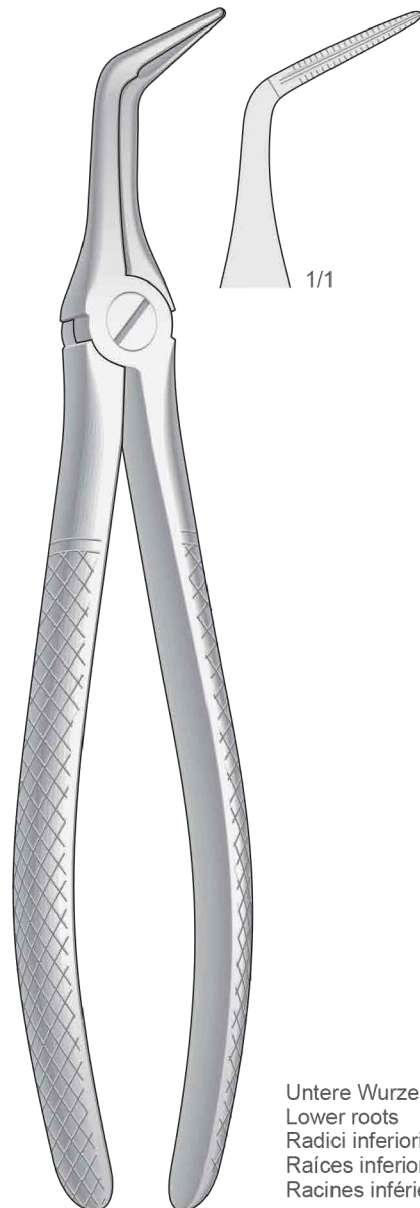
TM-49  
Fig. 49

Obere Wurzeln sehr feine  
Upper very fine roots  
Radici superiori molto sottili  
Raíces superiores muy finas  
Racines supérieures très fines



TM-48  
Fig. 48 - 44

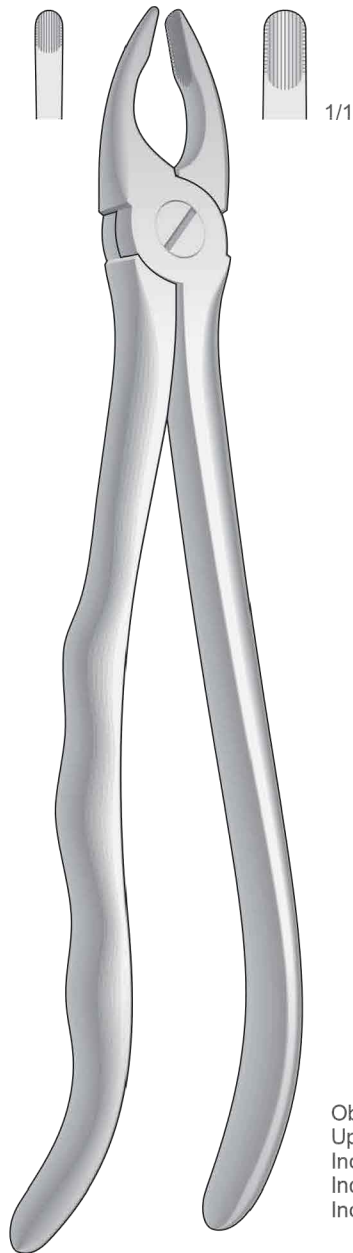
Obere Wurzeln  
Upper roots  
Radici superiori  
Raíces superiores  
Racines supérieures



TM-46L  
Fig. 46L

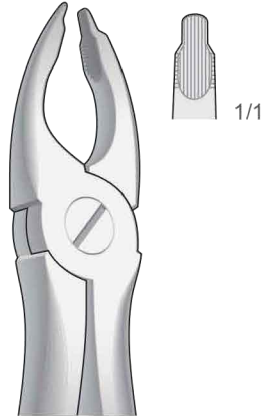
Untere Wurzeln  
Lower roots  
Radici inferiori  
Raíces inferiores  
Racines inférieures

Zahnzangen, Paßformgriff  
Extracting Forceps, Anatomical Handle  
Pinze per estrazione, Manico anatomico  
Pinzas da extracción, Mango anatómico  
Daviers, Manche anatique



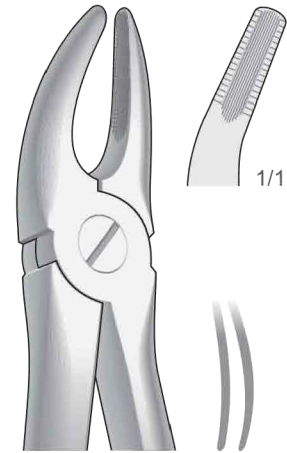
TM-S-3AN  
Fig. 3

Obere Schneide- und Eckzähne  
Upper incisors and cuspids  
Incisivi e canini superiori  
Incisivos y caninos superiores  
Incisives et canines supérieures



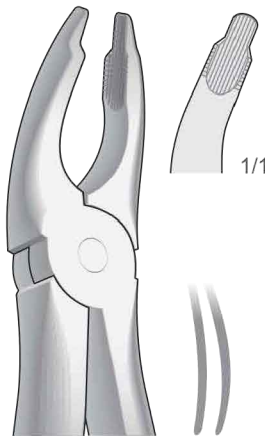
TM-S-34  
Fig. 34

Obere Schneide- und Eckzähne  
Upper incisors and cuspids  
Incisivi e canini superiori  
Incisivos y caninos superiores  
Incisives et canines supérieures



TM-S-7  
Fig. 7

Obere Prämolaren  
Upper premolars  
Premolari superiori  
Premolares superiores  
Prémolaires supérieures

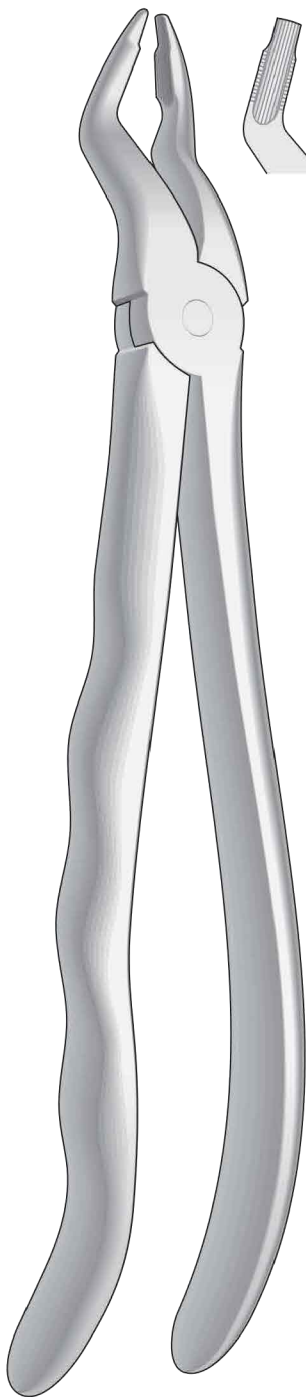


TM-S-35  
Fig. 35

Obere Schneidezähne und Prämolaren, tiefgreifend  
Upper incisors and bicuspid, deep-gripping  
Incisivi e premolari superiori, presa in profondità  
Incisivos y premolares superiores, a gran calado  
Incisives et prémolaires supérieures, à attaque profonde

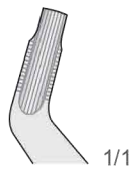


Zahnzangen, Paßformgriff  
Extracting Forceps, Anatomical Handle  
Pinze per estrazione, Manico anatomico  
Pinzas da extracción, Mango anatómico  
Daviers, Manche anatomique



TM-S-31  
Fig. 31

Obere Prämolaren  
Upper premolars  
Premolari superiori  
Premolares superiores  
Prémolaires supérieures



1/1



1/1



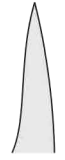
1/1

TM-S-66R  
Fig. 66R (89)

Obere Molaren, rechts  
Upper molars, right  
Molari superiori, destra  
Molares superiores, derechos  
Molaires supérieures, droites



1/1

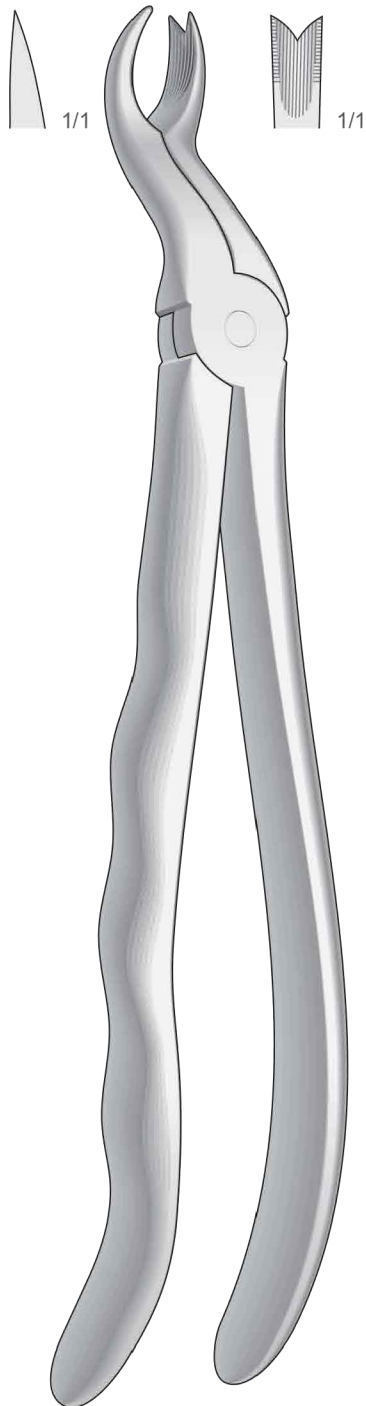


1/1

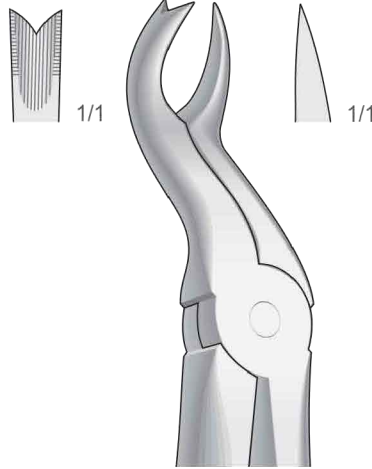
TM-S-66L  
Fig. 66L (90)

Obere Molaren, links  
Upper molars, left  
Molari superiori, sinistra  
Molares superiores, izquierdos  
Molaires supérieures, gauches

Zahnzangen, Paßformgriff  
Extracting Forceps, Anatomical Handle  
Pinze per estrazione, Manico anatomico  
Pinzas da extracción, Mango anatómico  
Daviers, Manche anatomique

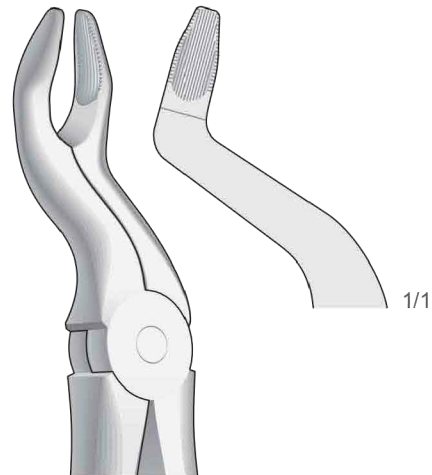


TM-S-67R  
Fig. 67R



TM-S-67L  
Fig. 67L

Obere Molaren, links  
Upper molars, left  
Molari superiori, sinistra  
Molares superiores, izquierdos  
Molaires supérieures, gauches

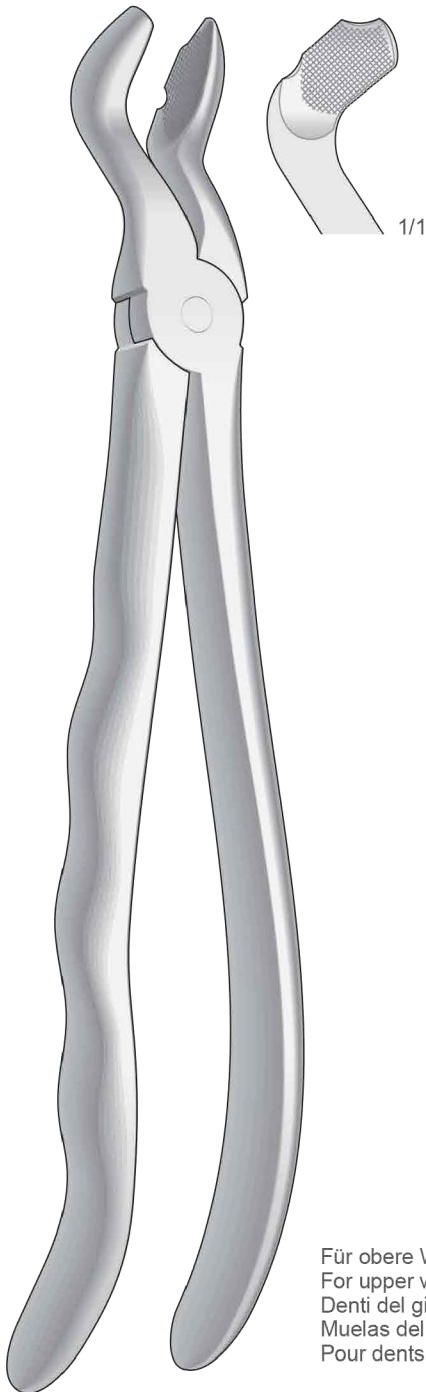


TM-S-67N  
Fig. 67N

Obere Molaren  
Upper molars  
Molari superiori  
Molares superiores  
Molaires supérieures

Obere Molaren, rechts  
Upper molars, right  
Molari superiori, destra  
Molares superiores, derechos  
Molaires supérieures, droites

Zahnzangen, Paßformgriff  
Extracting Forceps, Anatomical Handle  
Pinze per estrazione, Manico anatomico  
Pinzas da extracción, Mango anatómico  
Daviers, Manche anatomique



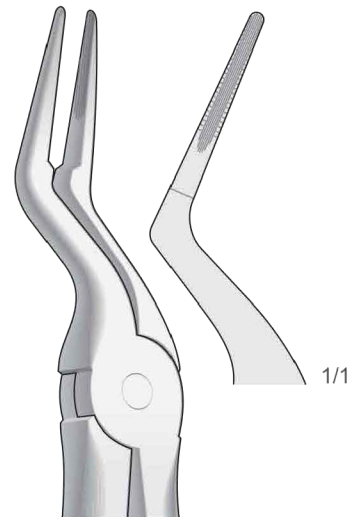
FELSCH  
TM-S-80  
Fig. 80

Für obere Weisheitszähne, mit Fangvorrichtung  
For upper wisdom teeth, with retaining device  
Denti del giudizio superiori, con dispositivo di presa  
Muelas del juicio superiores, con dispositivo de retencion  
Pour dents de sagesse supérieures, mors conçus pour recueillir la dent



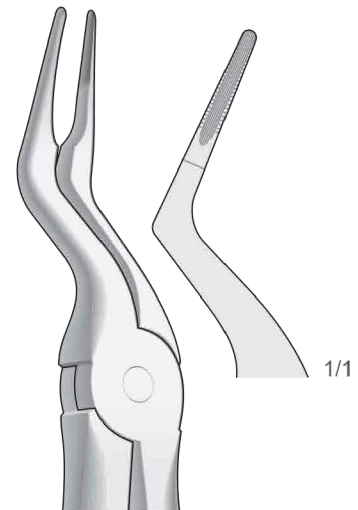
TM-S-51B  
Fig. TM-51B

Obere Dritte Molaren  
Upper molars  
Ottavi superiori  
Molares superiores  
Molaires supérieures



TM-S-97  
Fig. 97

Obere Wurzelplitterzange  
Upper Root Fragments  
Frammenti e radici superiori  
Fragmentos de raíces superiores  
Fragments des racines supérieures

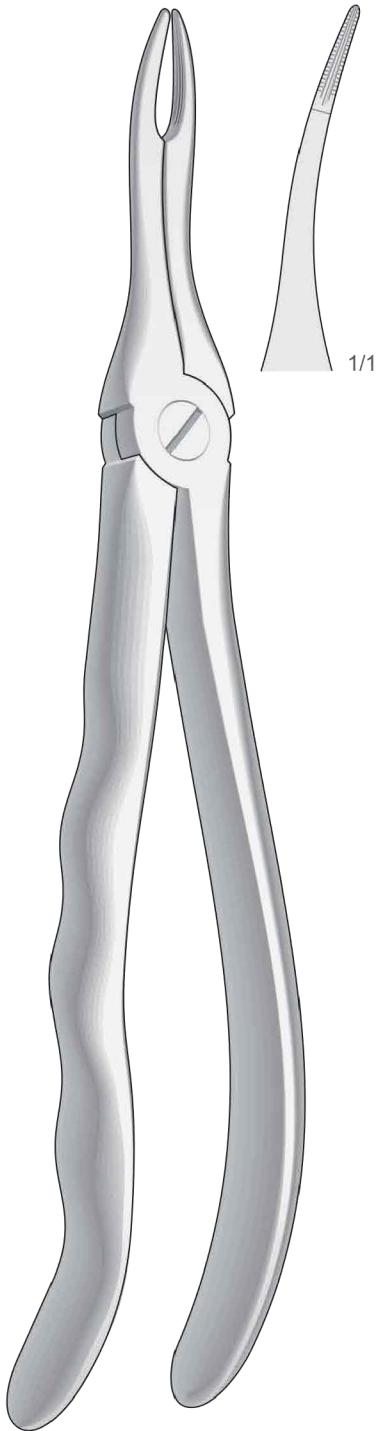


TM-S-97B  
Fig. 97B

Obere Wurzelplitterzange  
Upper Root Fragments  
Frammenti e radici superiori  
Fragmentos de raíces superiores  
Fragments des racines supérieures

Zahnzangen, Paßformgriff  
 Extracting Forceps, Anatomical Handle  
 Pinze per estrazione, Manico anatomico  
 Pinzas da extracción, Mango anatómico  
 Daviers, Manche anatomique

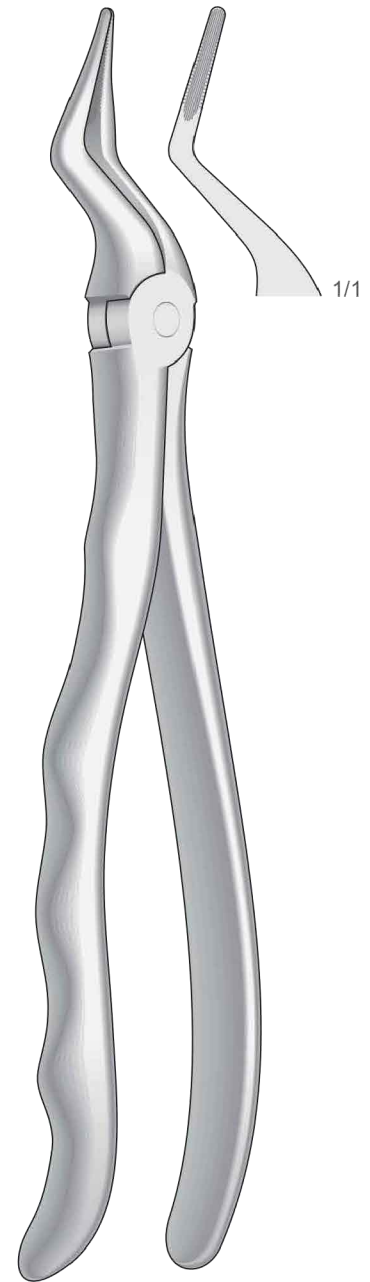
Obere Wurzeln sehr feine  
 Upper very fine roots  
 Radici superiori molto sottili  
 Raíces superiores muy finas  
 Racines supérieures très fines



TM-S-49  
 Fig. 49

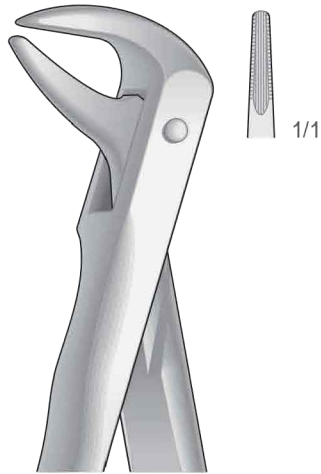


TM-S-51LX  
 Fig. 51LX



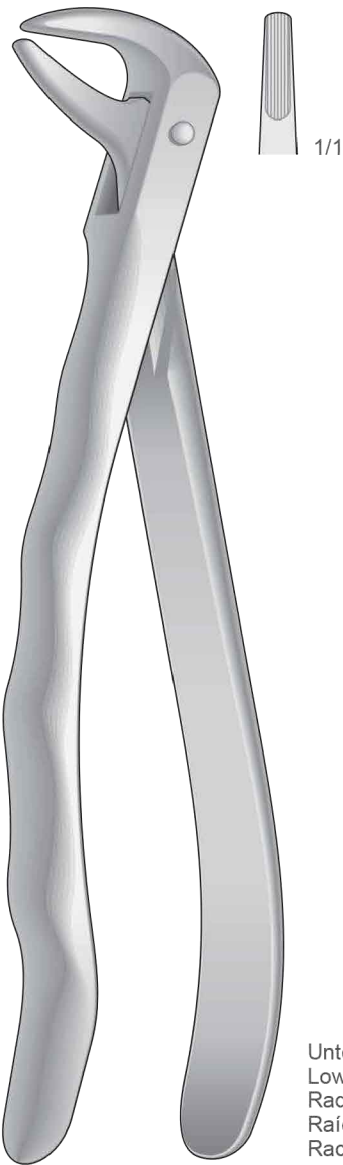
TM-S-351S  
 Fig. 351S

Zahnzangen, Paßformgriff  
Extracting Forceps, Anatomical Handle  
Pinze per estrazione, Manico anatomico  
Pinzas da extracción, Mango anatómico  
Daviers, Manche anatomique

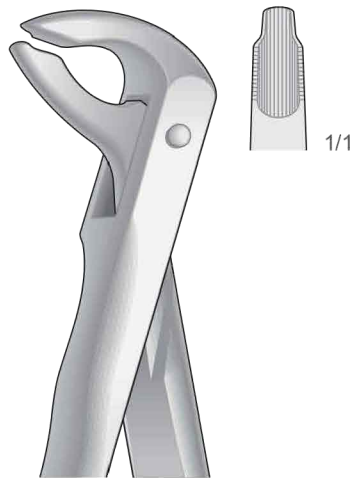


TM-I-74N  
Fig. 74N

Untere Wurzeln Schneide- und Eckzähne  
Lower roots, incisors and cuspids  
Radici, incisivi e canini inferiori  
Raíces, incisivos y caninos inferiores  
Racines, incisives et canines inférieures



TM-I-74  
Fig. 74



TM-I-36  
Fig. 36

Untere Wurzeln Schneide- und Eckzähne  
Lower roots, incisors and cuspids  
Radici, incisivi e canini inferiori  
Raíces, incisivos y caninos inferiores  
Racines, incisives et canines inférieures

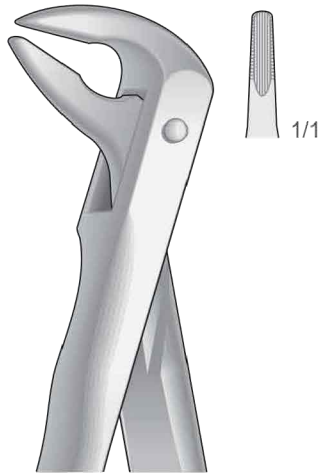


TM-I-36N  
Fig. 36N

Untere Wurzeln Schneide- und Eckzähne  
Lower roots, incisors and cuspids  
Radici, incisivi e canini inferiori  
Raíces, incisivos y caninos inferiores  
Racines, incisives et canines inférieures

Untere Wurzeln Schneide- und Eckzähne  
Lower roots, incisors and cuspids  
Radici, incisivi e canini inferiori  
Raíces, incisivos y caninos inferiores  
Racines, incisives et canines inférieures

Zahnzangen, Paßformgriff  
Extracting Forceps, Anatomical Handle  
Pinze per estrazione, Manico anatomico  
Pinzas da extracción, Mango anatómico  
Daviers, Manche anatomique



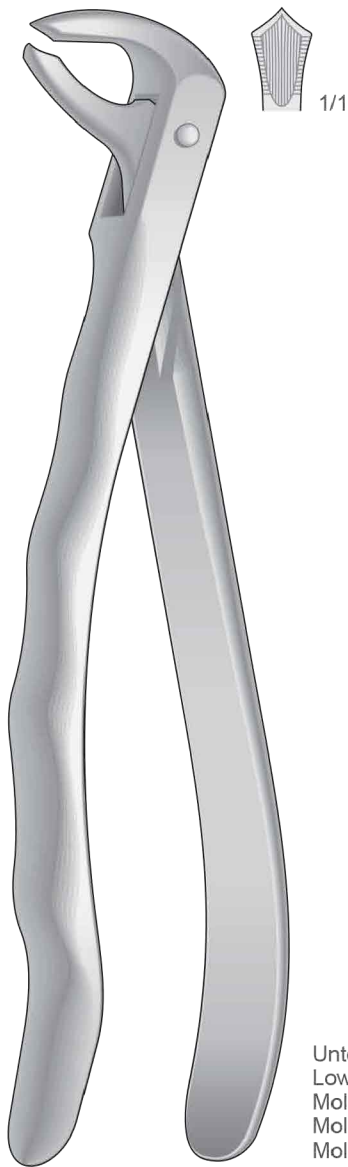
TM-I-59  
Fig. 59

Untere Wurzelplitterzange  
Lower Root Fragments  
Frammenti e radici inferiori  
Fragmentos de raíces inferiores  
Fragments des racines inférieures



TM-I-86C  
Fig. 86C

Untere Molaren mit kariesen oder abgebrochenen Kronen  
Lower molars with carious or broken caps  
Molari inferiori con corone cariate o spezzate  
Molares inferiores con coronas rotas o cariadas  
Molaires inférieures avec couronnes cariées ou cassées



TM-I-73  
Fig. 73



TM-I-13  
Fig. 13

Untere Prämolaren und Eckzähne  
Lower premolars and cuspids  
Canini e premolari inferiori  
Caninos y premolares inferiores  
Canines et prémolaires inférieures



TM-I-22  
Fig. 22

Untere Molaren  
Lower molars  
Molari inferiori  
Molares inferiores  
Molaires inférieures

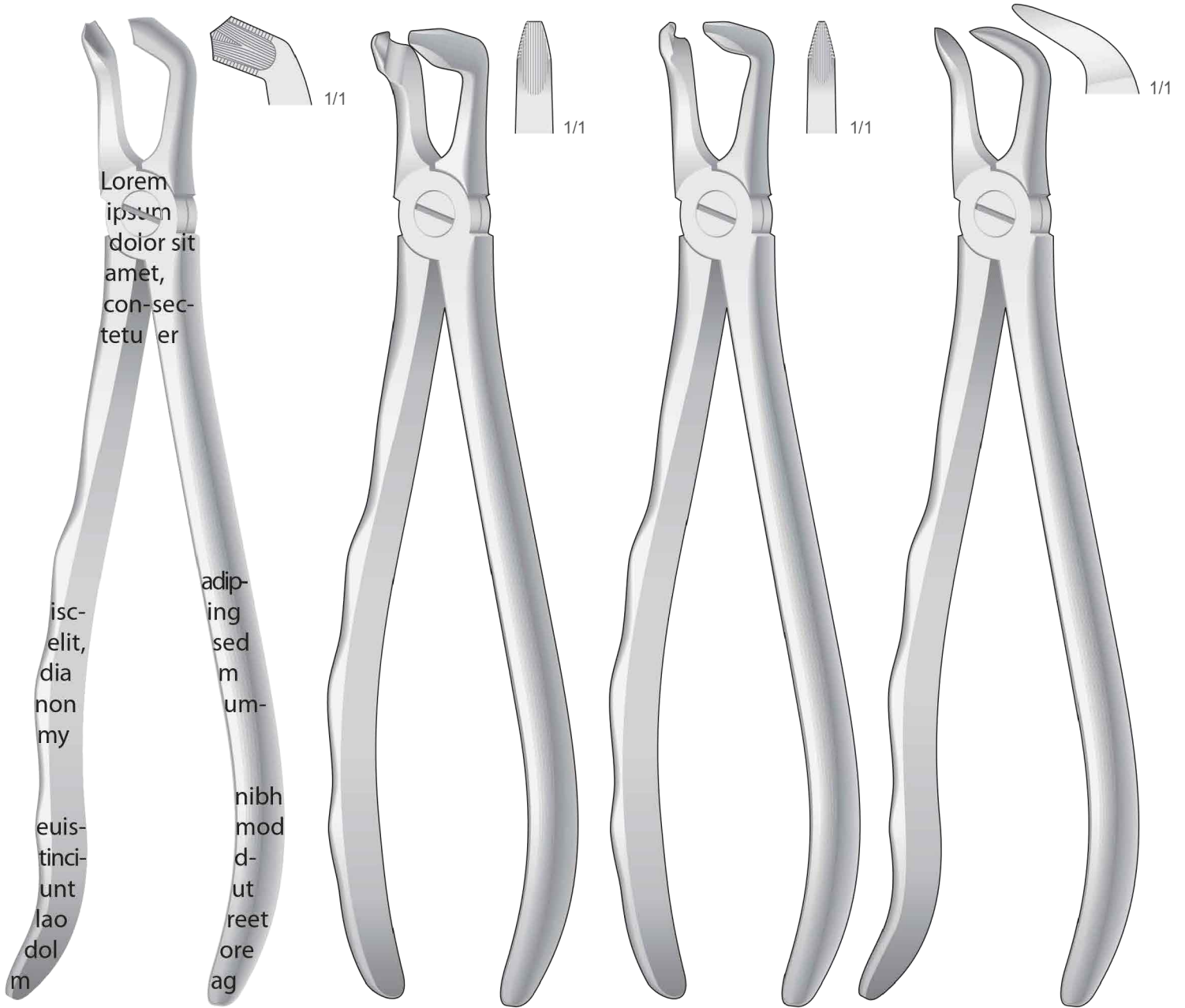
Untere Molaren  
Lower molars  
Molari inferiori  
Molares inferiores  
Molaires inférieures

Zahnzangen, Paßformgriff  
Extracting Forceps, Anatomical Handle  
Pinze per estrazione, Manico anatomico  
Pinzas da extracción, Mango anatómico  
Daviers, Manche anatomique

Untere Weisheitszähne  
Lower wisdom teeth  
Denti del giudizio inferiori  
Muelas del juicio inferiores  
Dent de sagesse inférieures

Untere Prämolaren  
Lower premolars  
Premolari inferiori  
Premolares inferiores  
Prémolaires inférieures

Untere Molaren  
Lower Molars  
Molari inferiori  
Molares inferiores  
Molaires inférieures



>Lorem ipsum dolor sit amet, consectetur

isc-elit, dia non my

adip-ing sed m um-

euis-tinci-unt lao dol m

nibh mod d-ut reet ore ag

TM-I-79  
Fig. 79

TM-I-79N  
Fig. 79N

TM-I-46N  
Fig. 46N

TM-I-87  
Fig. 87

Zahnzangen, Paßformgriff  
 Extracting Forceps, Anatomical Handle  
 Pinze per estrazione, Manico anatomico  
 Pinzas da extracción, Mango anatómico  
 Daviers, Manche anatomique



TM-I-46LX  
 Fig. 46LX



TM-I-46L  
 Fig. 46L



Zahnzangen, Paßformgriff  
Extracting Forceps, Anatomical Handle  
Pinze per estrazione, Manico anatomico  
Pinzas da extracción, Mango anatómico  
Daviers, Manche anatomique

Untere Molaren und Weisheitszähne  
Lower molars and wisdom teeth  
Molari e denti del giudizio inferiori  
Molares y muelas del juicio inferiores  
Molaires et dent de sagesse inférieures

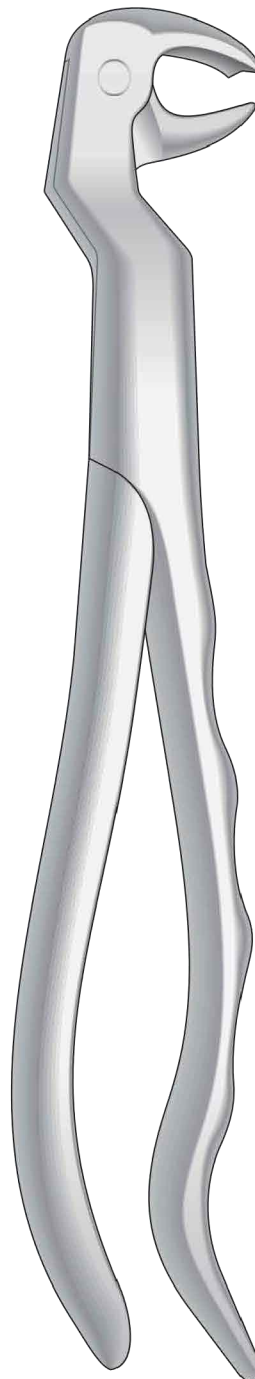


TM-I-22 ½ L



1/1

Links  
Left  
Sinistra  
Izquierdos  
Gauches



TM-I-22 ½ R

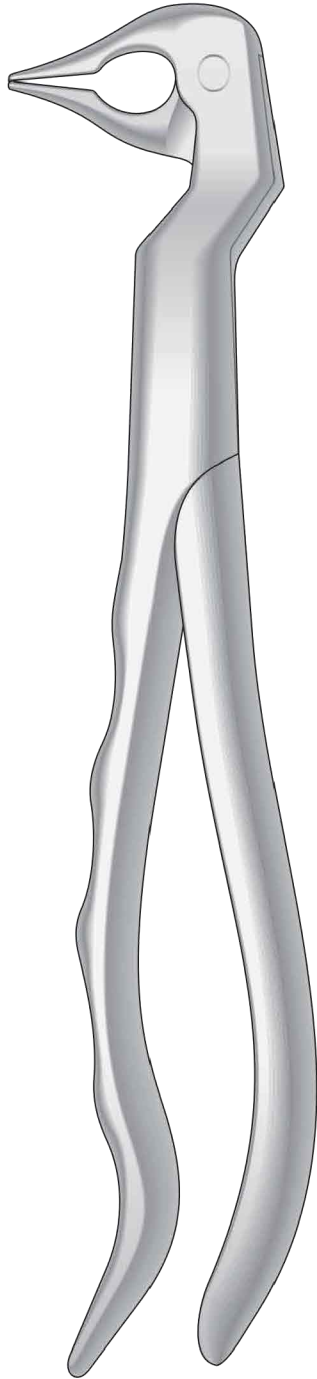


1/1

Rechts  
Right  
Destra  
Derechos  
Droites

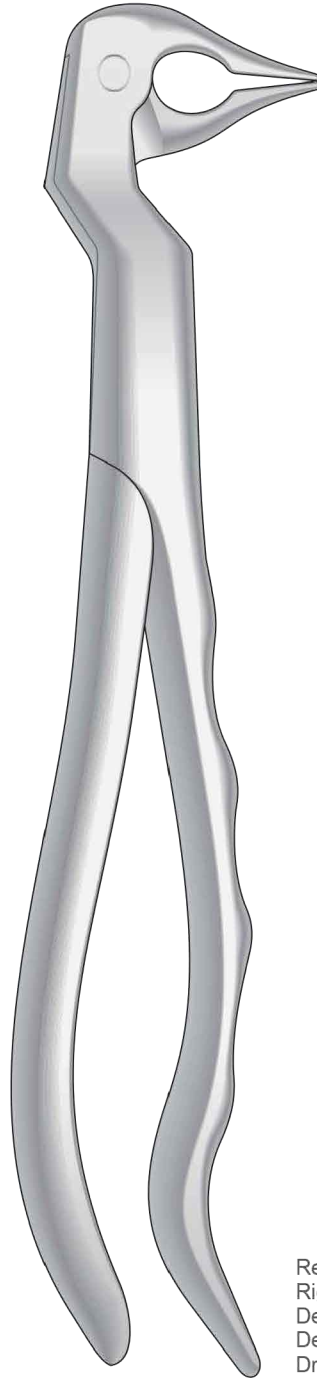
Zahnzangen, Paßformgriff  
 Extracting Forceps, Anatomical Handle  
 Pinze per estrazione, Manico anatomico  
 Pinzas da extracción, Mango anatómico  
 Daviers, Manche anatomique

Untere Wurzeln sehr feine  
 Lower very fine roots  
 Radici inferiori molto sottili  
 Raíces inferiores muy finas  
 Racines inférieures très fines



Links  
 Left  
 Sinistra  
 Izquierdos  
 Gauches

TM-I-133 L  
 Fig.133



Rechts  
 Right  
 Destra  
 Derechos  
 Droites

TM-I-133 R  
 Fig.133



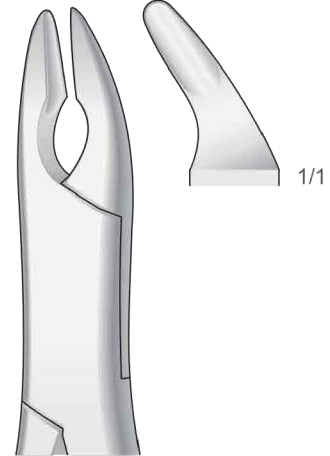
TM-I-333S  
 Fig.333S

Zahnzangen, Amerikanische Form  
Extracting Forceps, American Pattern  
Pinze per estrazione, Forma Americana  
Pinzas da extracción, Forma Americana  
Daviers, Forme Américaine



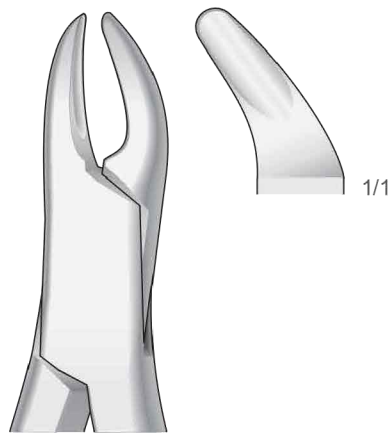
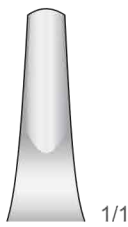
CRYER  
TM-AM-150  
Fig. 150

Obere Prämolaren, Schneidezähne, Wurzeln  
Upper Bicuspid, incisors and roots  
Premolari, incisivi e radici superiori  
Premolares, incisivos y raíces superiores  
Prémolaires, incisives et racines supérieures



CRYER  
TM-AM-150A  
Fig. 150A

Obere Prämolaren, Schneidezähne, Wurzeln  
Upper Bicuspid, incisors and roots  
Premolari, incisivi e radici superiori  
Premolares, incisivos y raíces superiores  
Prémolaires, incisives et racines supérieures

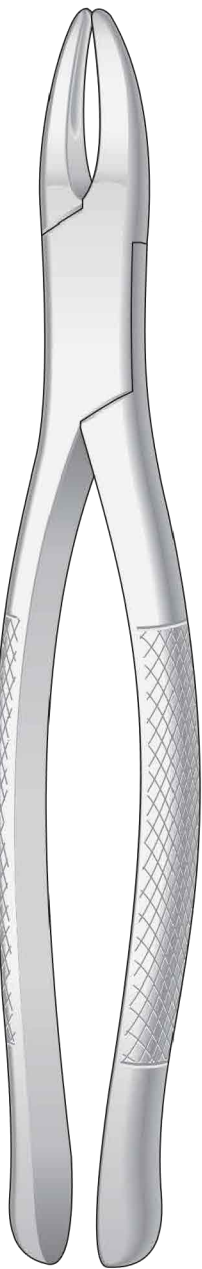


TM-AM-62  
Fig. 62

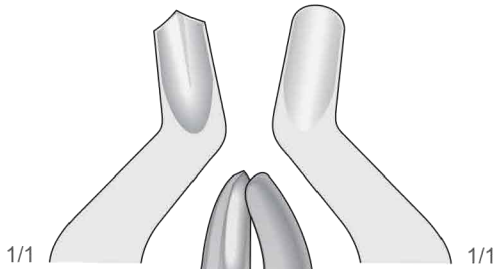
Schneidezähne, Prämolaren, Milchzähne  
Incisors, premolars, deciduous teeth  
Incisivi, premolari, denti da latte  
Incisivos, premolares, dientes de leche  
Incisives, prémolaires, dents de lait

Obere Schneide- und Eckzähne  
Upper incisors and cuspids  
Incisivi e canini superiori  
Incisivos y caninos superiores  
Incisives et canines supérieures

TM-AM-1  
Fig. 1

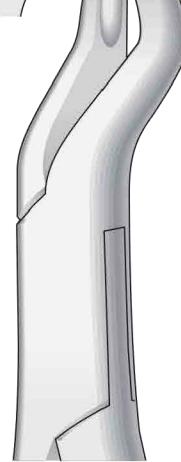
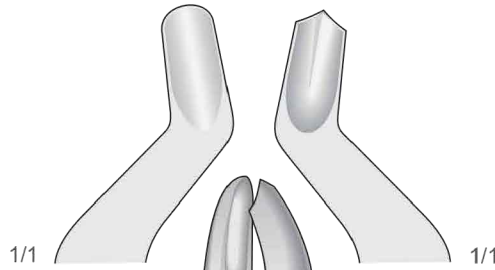


Zahnzangen, Amerikanische Form  
Extracting Forceps, American Pattern  
Pinze per estrazione, Forma Americana  
Pinzas da extracción, Forma Americana  
Daviers, Forme Américaine



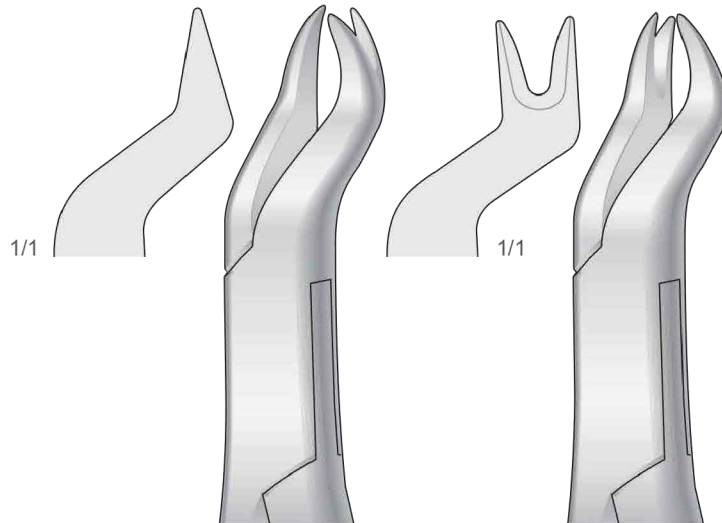
TM-AM-53R  
Fig. 53R

Obere Molaren, Rechts  
Upper Molars, Right  
Molari superiori, Destra  
Molares superiores, Derechos  
Molaires supérieures, Droites



TM-AM-53L  
Fig. 53L

Obere Molaren, Links  
Upper Molars, Left  
Molari superiori, Sinistra  
Molares superiores, Izquierdos  
Molaires supérieures, Gauches



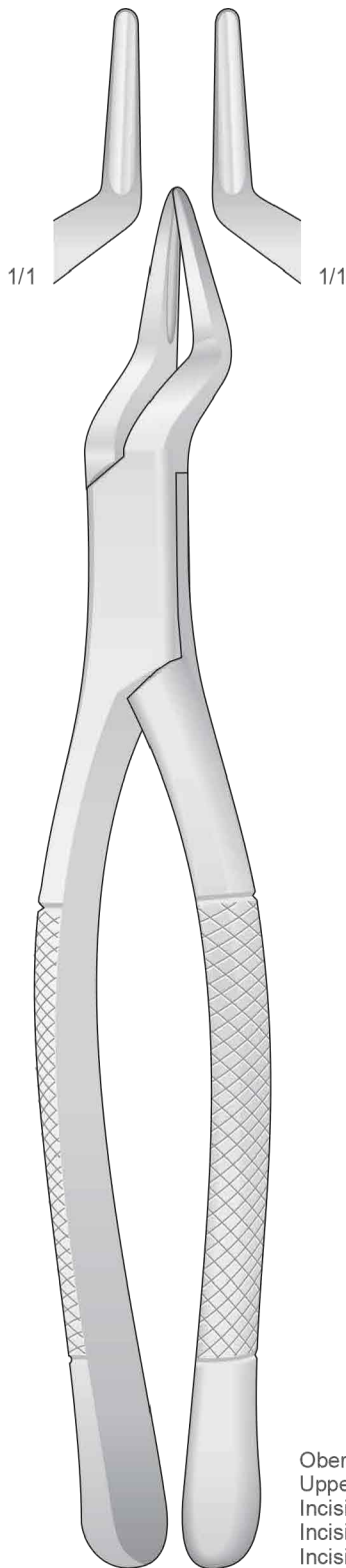
NEVIUS  
TM-AM-88R  
Fig. 88R

Obere Molaren, Rechts  
Upper Molars, Right  
Molari superiori, Destra  
Molares superiores, Derechos  
Molaires supérieures, Droites

NEVIUS  
TM-AM-88L  
Fig. 88L

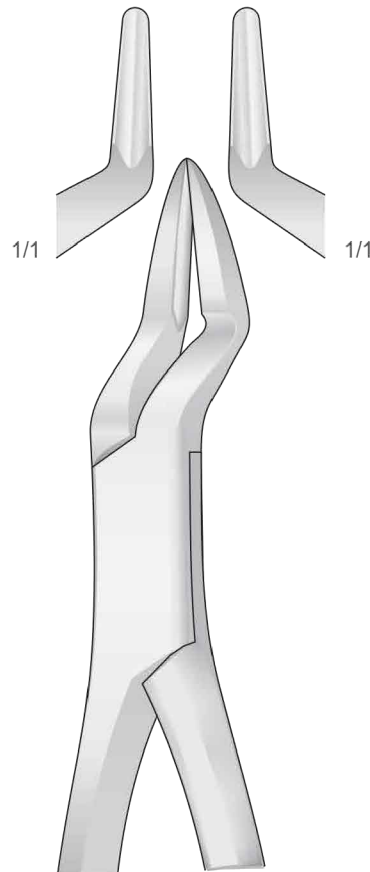
Obere Molaren, Links  
Upper Molars, Left  
Molari superiori, Sinistra  
Molares superiores, Izquierdos  
Molaires supérieures, Gauches

Zahnzangen, Amerikanische Form  
Extracting Forceps, American Pattern  
Pinze per estrazione, Forma Americana  
Pinzas da extracción, Forma Americana  
Daviers, Forme Américaine



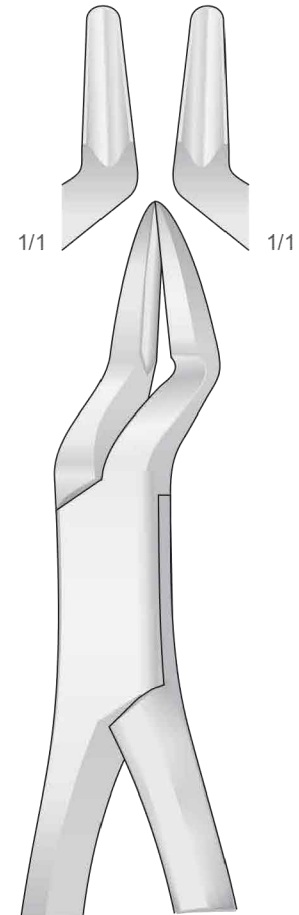
TM-AM-65  
Fig.65

Obere Schneidezähne und Wurzeln  
Upper Incisors and Roots  
Incisivi e radici superiori  
Incisivos y raíces superiores  
Incisives et racines supérieures



PARMLY  
TM-AM-32A  
Fig. 32A

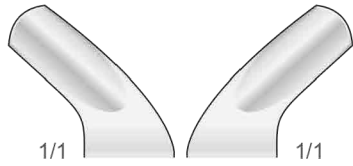
Obere Wurzeln und Prämolaren  
Upper Roots and Premolars  
Radici e premolari superiori  
Raíces y premolares superiores  
Racines et prémolaires supérieures



PARMLY  
TM-AM-32  
Fig. 32

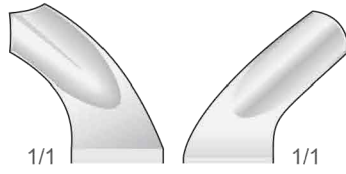
Obere Prämolaren und Molaren  
Upper Premolars and Molars  
Premolari e molari superiori  
Premolares y Molares superiores  
Prémolaires et Molaires supérieures

Zahnzangen, Amerikanische Form  
Extracting Forceps, American Pattern  
Pinze per estrazione, Forma Americana  
Pinzas da extracción, Forma Americana  
Daviers, Forme Américaine



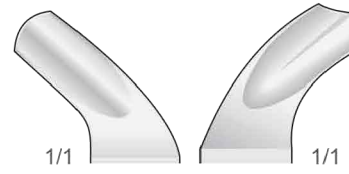
TM-AM-24  
Fig. 24

Obere Molaren  
Upper Molars  
Molari superiori  
Molares superiores  
Molaires supérieures



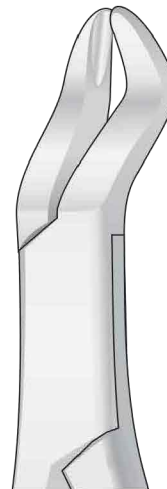
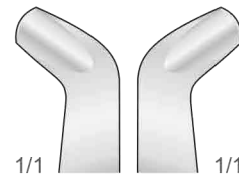
HARRIS  
TM-AM-18R  
Fig. 18R

Obere Molaren, Rechts  
Upper Molars, Right  
Molari superiori, Destra  
Molares superiores, Derechos  
Molaires supérieures, Droites



HARRIS  
TM-AM-18L  
Fig. 18L

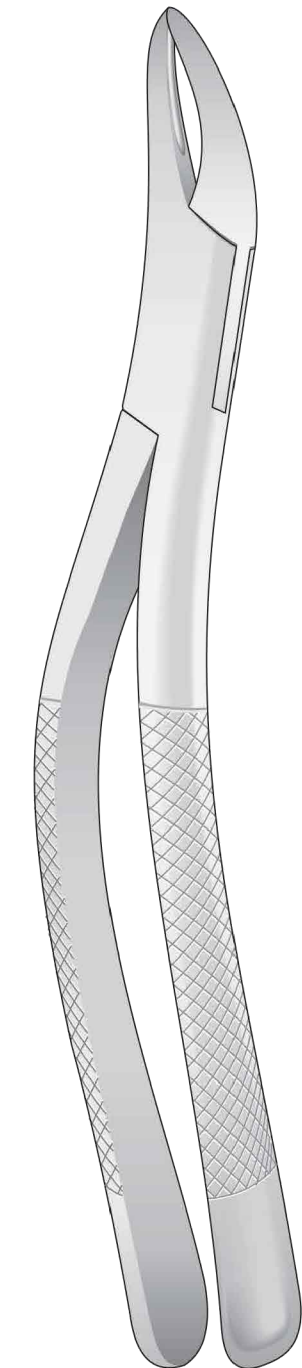
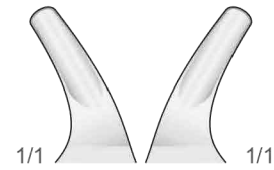
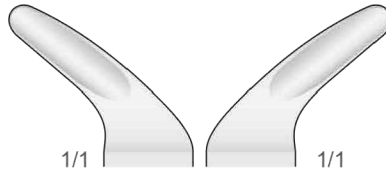
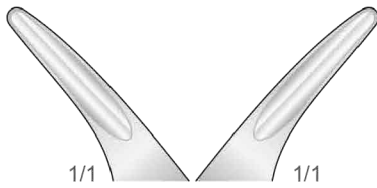
Obere Molaren, Links  
Upper Molars, Left  
Molari superiori, Sinistra  
Molares superiores, Isquirdos  
Molaires supérieures, Gauches



TM-AM-210  
Fig. 210

Obere Molaren  
Upper Molars  
Molari superiori  
Molares superiores  
Molaires supérieures

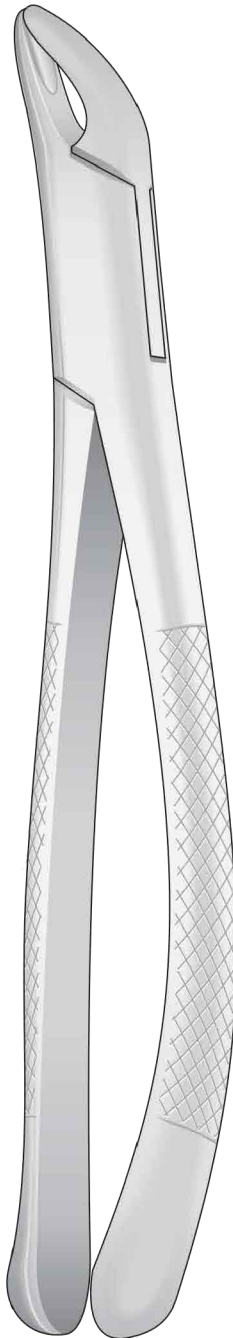
Zahnzangen, Amerikanische Form  
Extracting Forceps, American Pattern  
Pinze per estrazione, Forma Americana  
Pinzas da extracción, Forma Americana  
Daviers, Forme Américaine



Obere und Untere  
Upper and lower  
Superiori e inferiori  
Superiores y inferiores  
Supérieures et inférieures

Wurzeln  
Roots  
Radici  
Raices  
Racines

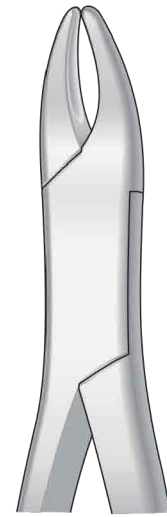
TOMES  
TM-AM-69  
Fig.69



Untere  
Lower  
Inferiori  
Inferiores  
Inférieures

Schneidezähne, Prämolaren, Wurzeln  
Incisors, Premolars, Roots  
Incisivi, premolari, radici  
Incisivos, premolares, raices  
Incisives, prémolaires, racines

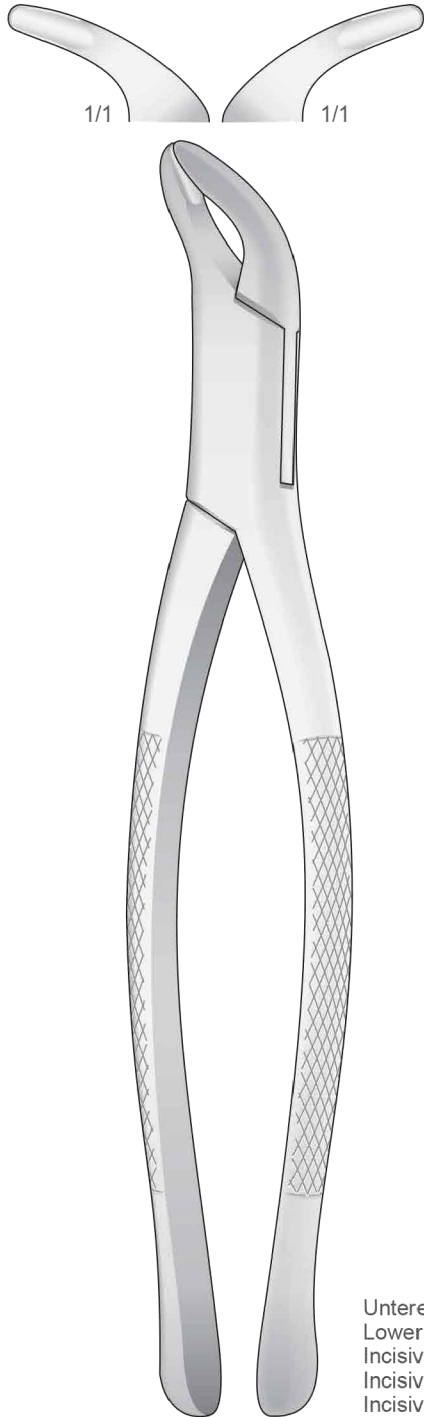
CRYER  
TM-AM-1TM-51  
Fig.1TM-51



HULL  
TM-AM-101  
Fig. 101

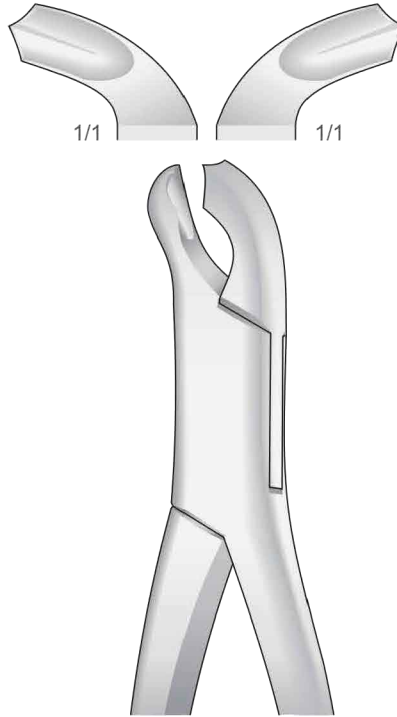
Für Eckzähne und Prämolaren,  
Universalzange und Kinderzange  
For canines and Premolars,  
Universal and Tooth forceps for children  
Canini e premolari,  
universale e per bambini  
Caninos y premolares,  
universal y para niños  
Canines et prémolaires,  
universel et pour enfants

Zahnzangen, Amerikanische Form  
Extracting Forceps, American Pattern  
Pinze per estrazione, Forma Americana  
Pinzas da extracción, Forma Americana  
Daviers, Forme Américaine



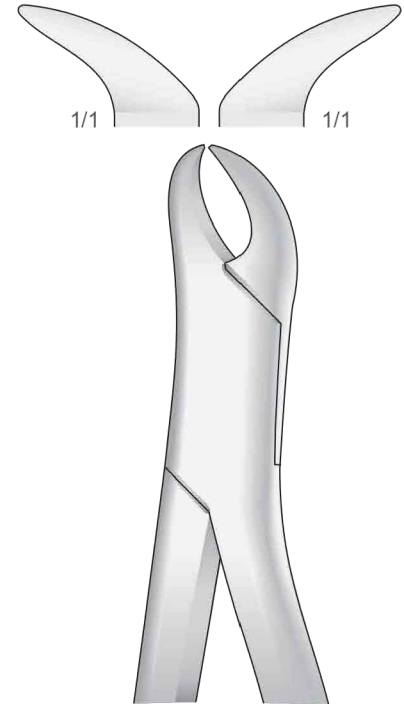
TM-AM-203  
Fig. 203

Untere Schneidezähne, Prämolaren, Wurzeln  
Lower Incisors, Premolars, Roots  
Incisivi, premolari, radici inferiori  
Incisivos, premolares, raices inferiores  
Incisives, prémolaires, racines inférieures



TM-AM-17  
Fig. 17

Untere Molaren  
Lower Molars  
Molari inferiori  
Molares inferiores  
Molaires inférieures

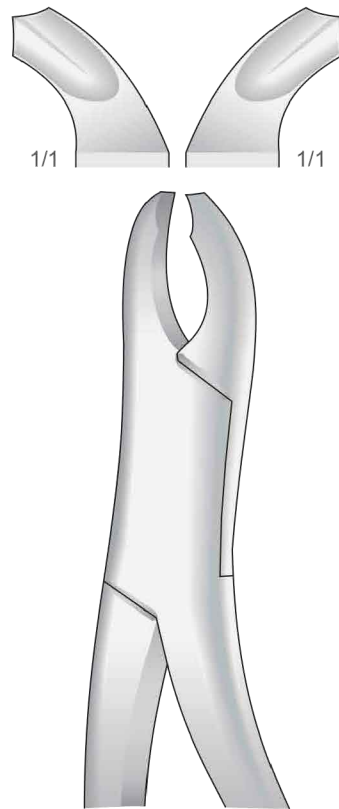
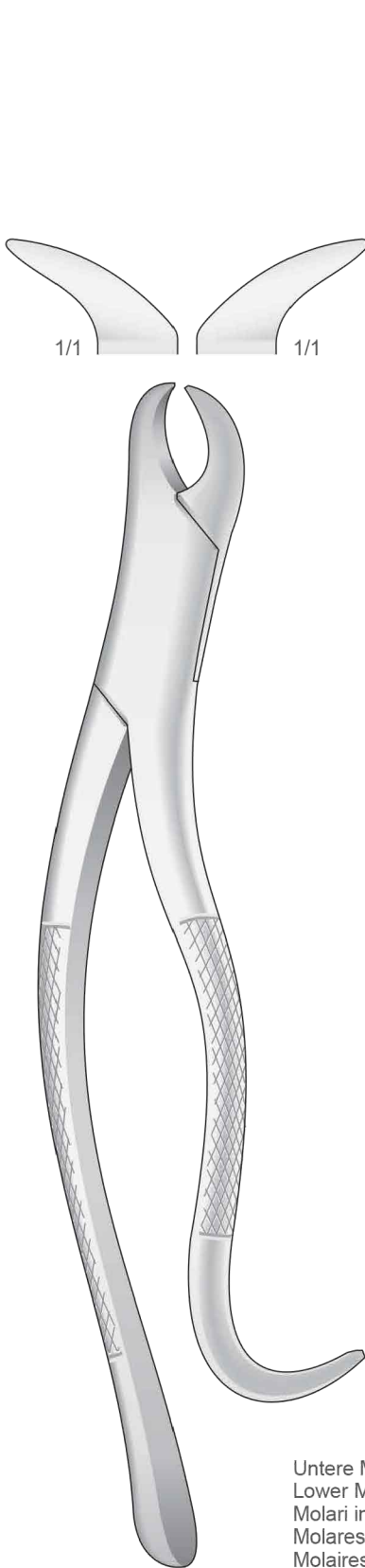


TM-AM-23  
Fig. 23

Untere Molaren  
Lower Molars  
Molari inferiori  
Molares inferiores  
Molaires inférieures

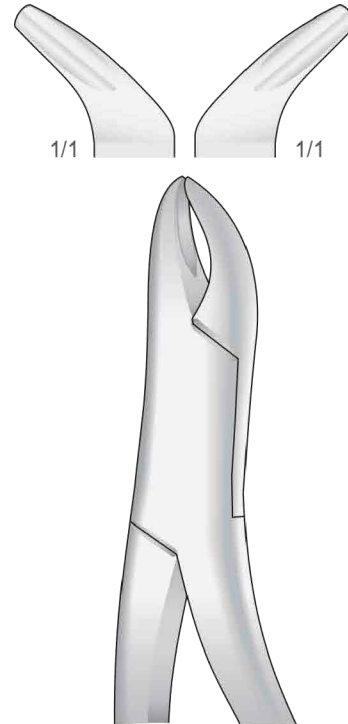


Zahnzangen, Amerikanische Form  
Extracting Forceps, American Pattern  
Pinze per estrazione, Forma Americana  
Pinzas da extracción, Forma Americana  
Daviers, Forme Américaine



HARRIS  
TM-AM-15  
Fig. 15

Untere Molaren  
Lower Molars  
Molari inferiori  
Molares inferiores  
Molaires inférieures



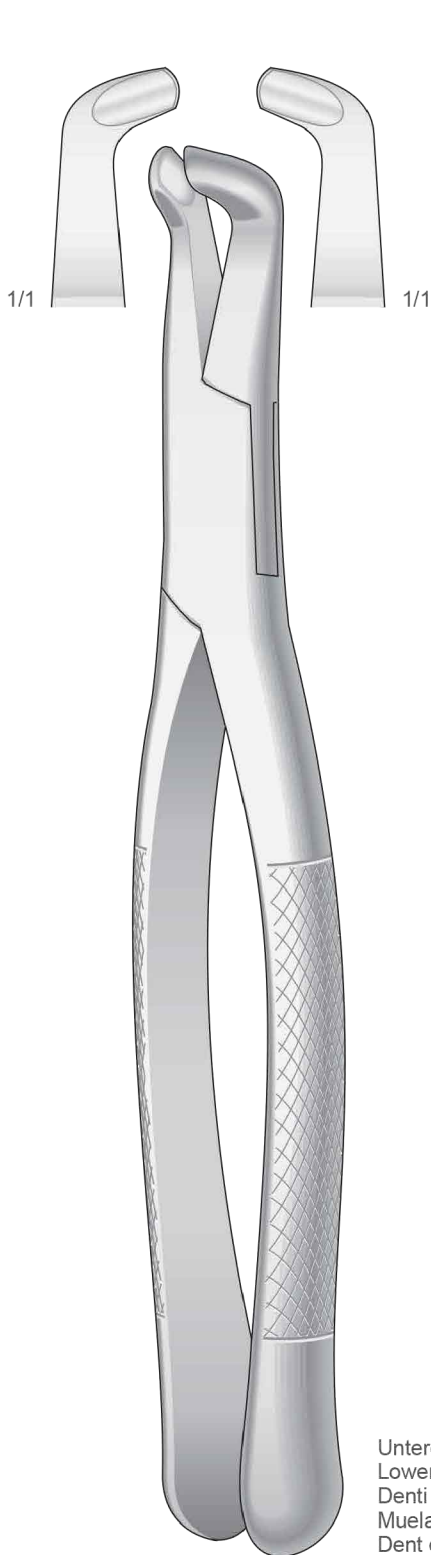
TM-AM-103  
Fig. 103

Untere Schneidezähne, Prämolaren, Wurzeln  
Lower Incisors, Premolars, Roots  
Incisivi, premolari, radici inferiori  
Incisivos, premolares, raices inferiores  
Incisives, prémolaires, racines inférieures

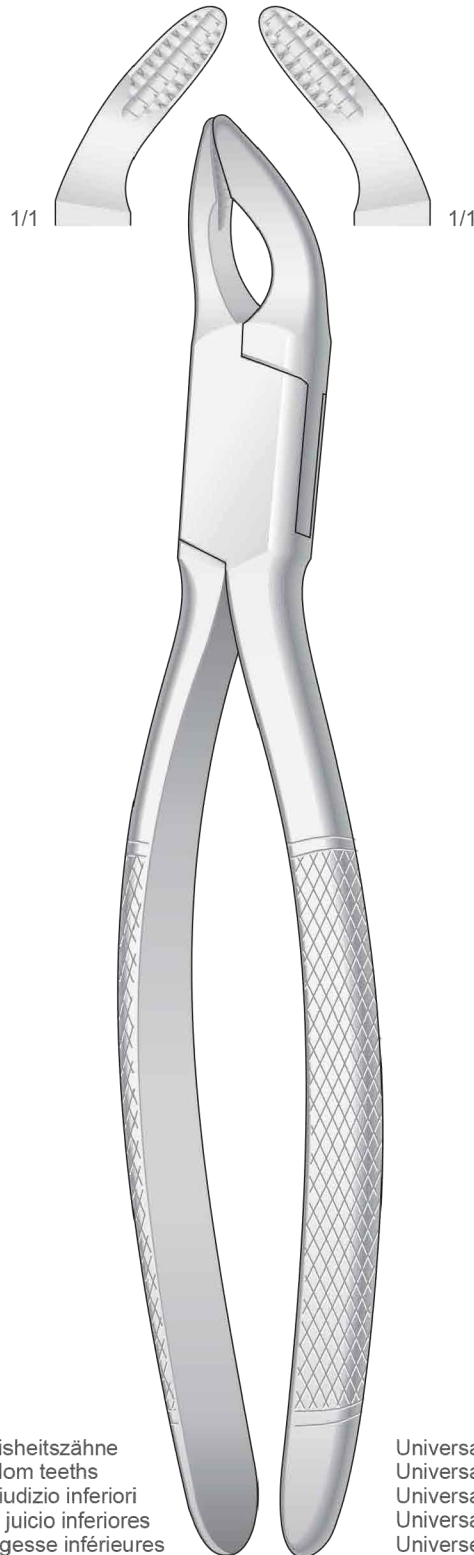
TM-AM-16  
Fig. 16

Untere Molaren  
Lower Molars  
Molari inferiori  
Molares inferiores  
Molaires inférieures

Zahnzangen, Amerikanische Form  
Extracting Forceps, American Pattern  
Pinze per estrazione, Forma Americana  
Pinzas da extracción, Forma Americana  
Daviers, Forme Américaine



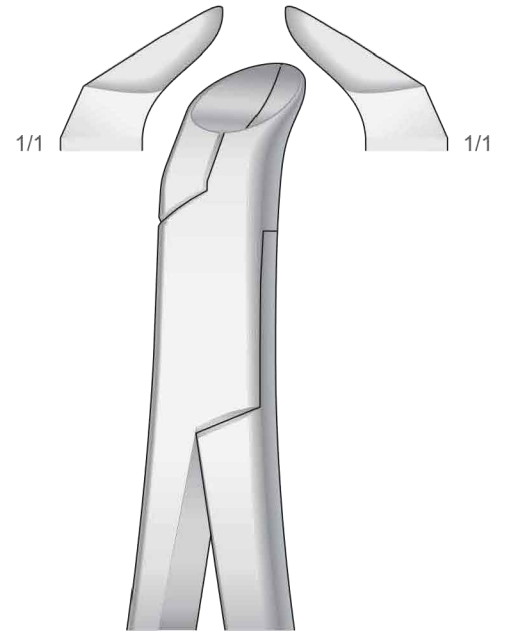
TM-AM-222  
Fig. 222



COHEN  
TM-AM-250

Untere Weisheitszähne  
Lower wisdom teeth  
Denti del giudizio inferiori  
Muelas del juicio inferiores  
Dent de sagesse inférieures

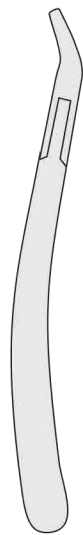
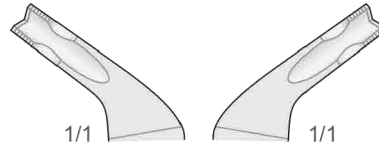
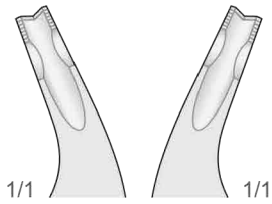
Universal  
Universal  
Universale  
Universal  
Universel



PHYSICK  
TM-AM-5  
Fig. 5

Untere Weisheitszähne  
Lower wisdom teeth  
Denti del giudizio inferiori  
Muelas del juicio inferiores  
Dent de sagesse inférieures

Zahnzangen, Amerikanische Form  
Extracting Forceps, American Pattern  
Pinze per estrazione, Forma Americana  
Pinzas da extracción, Forma Americana  
Daviers, Forme Américaine



Obere  
Upper  
Superiori  
Superiores  
Supérieures

Prämolaren, Schneidezähne und Wurzeln  
Bicuspids, incisors and roots  
Premolari, incisivi e radici  
Premolares, incisivos y raices  
Premolaires, incisives et racines



Untere  
Lower  
Inferiori  
Inferiores  
Inférieures

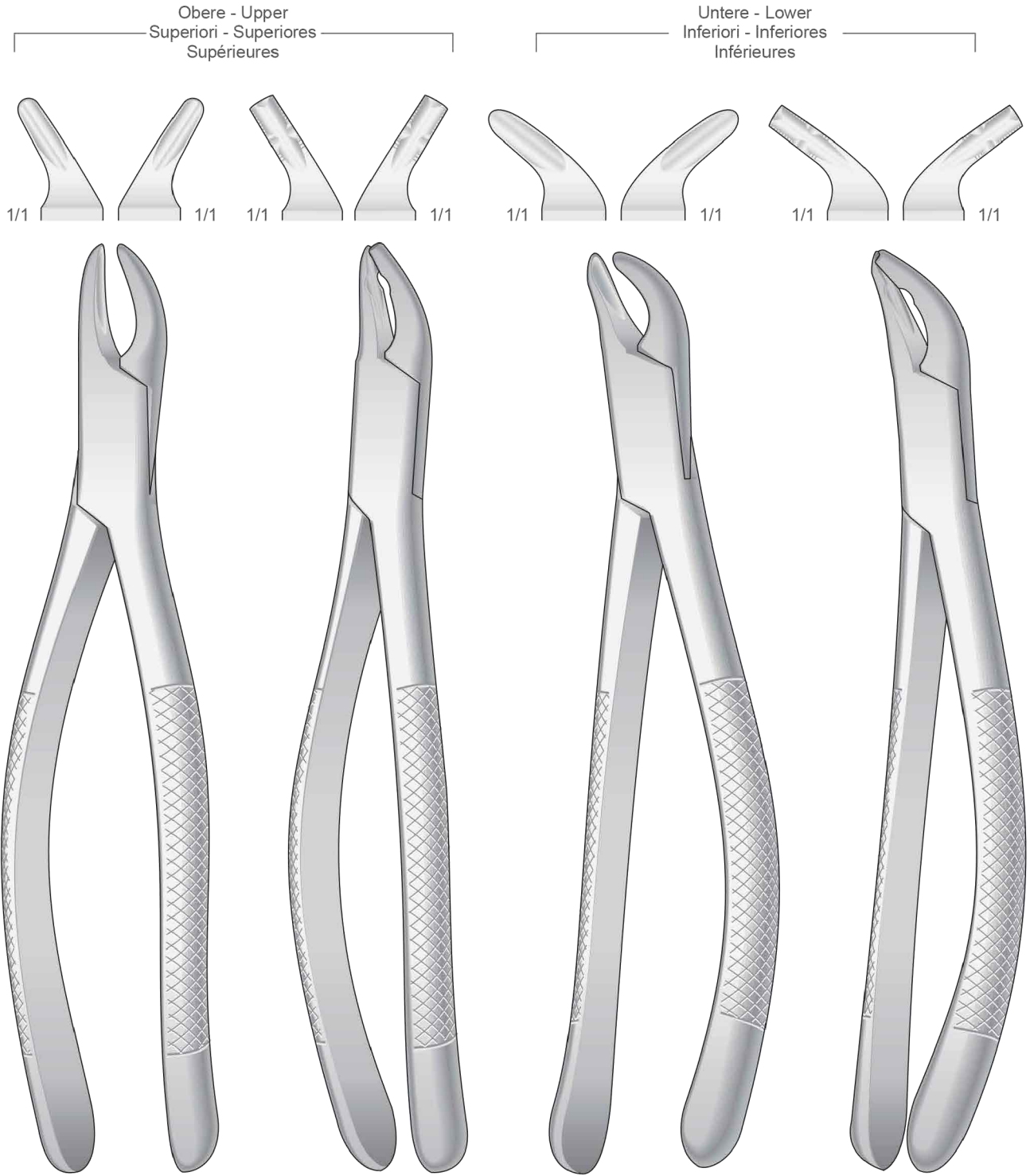
Prämolaren, Schneidezähne und Wurzeln  
Bicuspids, incisors and roots  
Premolari, incisivi e radici  
Premolares, incisivos y raices  
Premolaires, incisives et racines

TM-AM-150X  
Fig. 150AS

TM-AM-1TM-51X  
Fig. 1TM-51AS

Zahnzangen, Amerikanische Form  
Extracting Forceps, American Pattern  
Pinze per estrazione, Forma Americana  
Pinzas da extracción, Forma Americana  
Daviers, Forme Américaine

Für Kinder  
For children  
Per bambini  
Para niños  
Pour enfants



CRYER  
TM-AM-150S  
Fig.150 S

TM-AM-150AS  
Fig.150 XAS

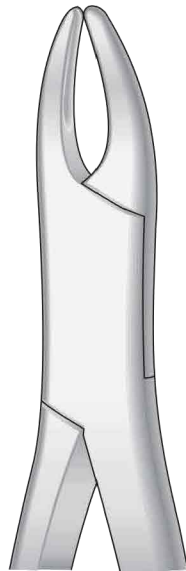
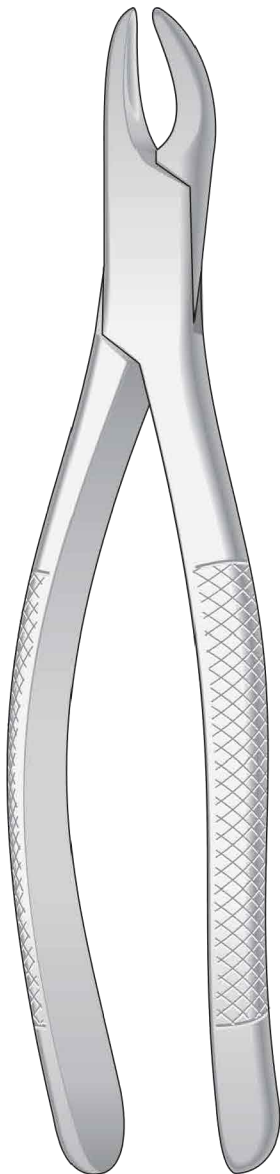
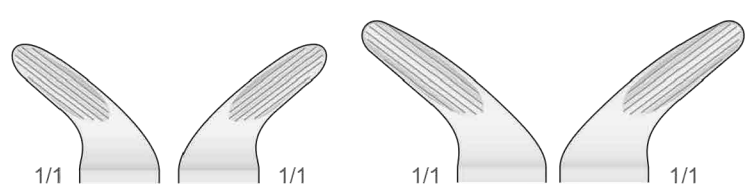
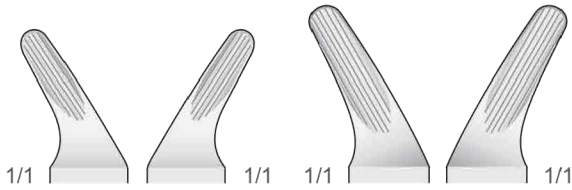
CRYER  
TM-AM-151S  
Fig.151 S

TM-AM-151AS  
Fig.151 XAS

Geriefte - Serrated - Striata - Estriadas - Striées

Obere Schneidezähne, Prämolaren, Wurzeln  
Upper incisors, premolars, roots  
Incisivi, premolari e radici superiori  
Incisivos, premolares y raíces superiores  
Incisives, premolaires et racines supérieures

Untere Schneidezähne, Prämolaren, Wurzeln  
Lower incisors, premolars, roots  
Incisivi, premolari e radici inferiori  
Incisivos, premolares y raíces inferiores  
Incisives, premolaires et racines inférieures

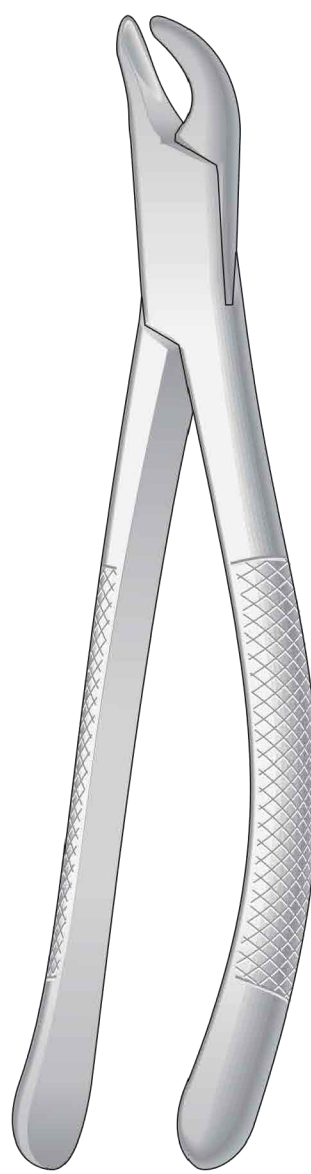


CRYER  
TM-AMG-150  
Fig. 150

Für Erwachsene  
For adults  
Per adulti  
Para adultos  
Pour adults

Für Kinder  
For children  
Per bambini  
Para niños  
Pour enfants

CRYER  
TM-AMG-150S  
Fig.150 S



CRYER  
TM-AMG-1TM-51  
Fig. 1TM-51

Für Erwachsene  
For adults  
Per adulti  
Para adultos  
Pour adults

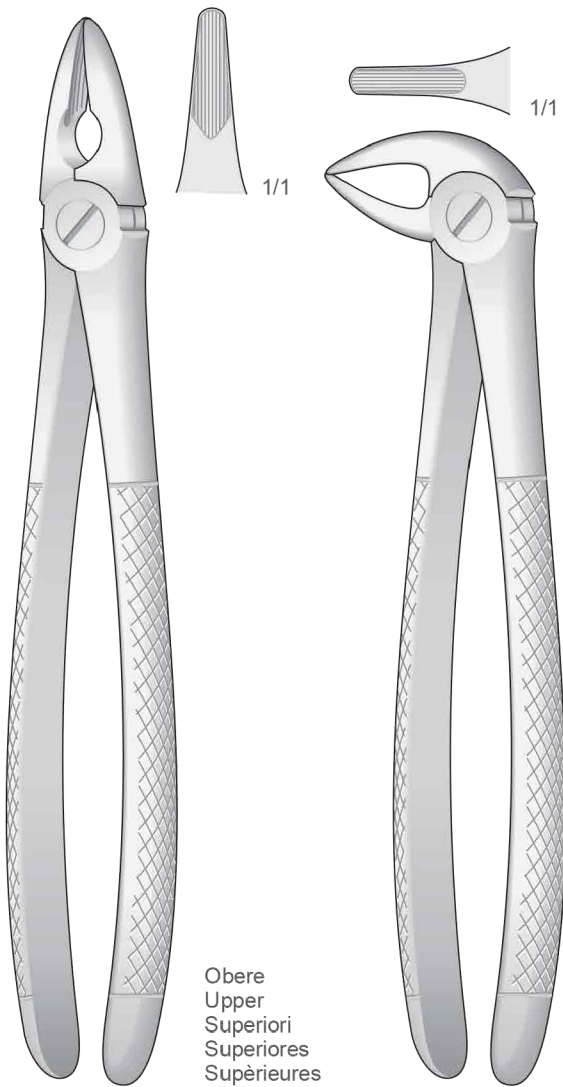
Für Kinder  
For children  
Per bambini  
Para niños  
Pour enfants

CRYER  
TM-AMG-151S  
Fig.151 S

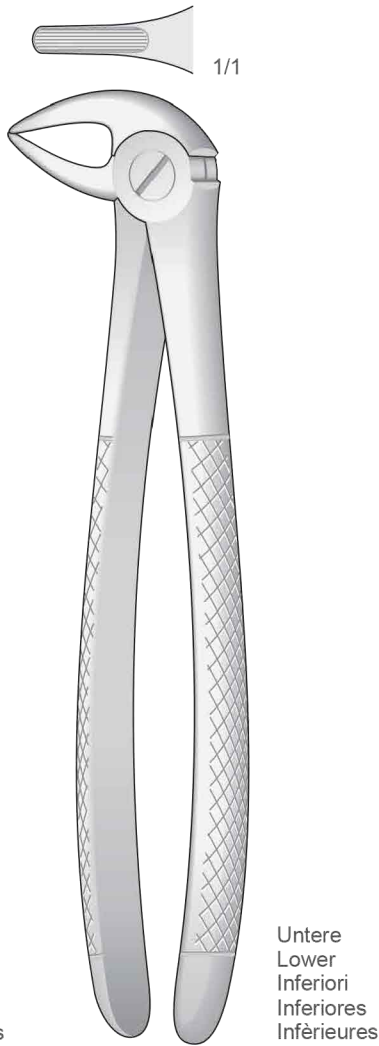
Zahnzangen  
Extracting Forceps  
Pinze per estrazione  
Pinzas da extracción  
Daviers

Schneidezähne, Eckzähne, Wurzeln  
Incisors, bicuspid and roots  
Incisivi, canini e radici  
Incisivos, caninos y raices  
Incisives, canines et racines

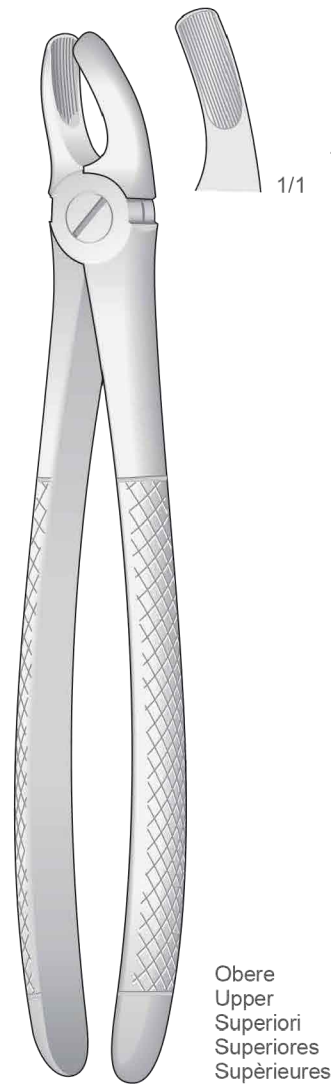
Molaren  
Molars  
Molari  
Molares  
Molaires



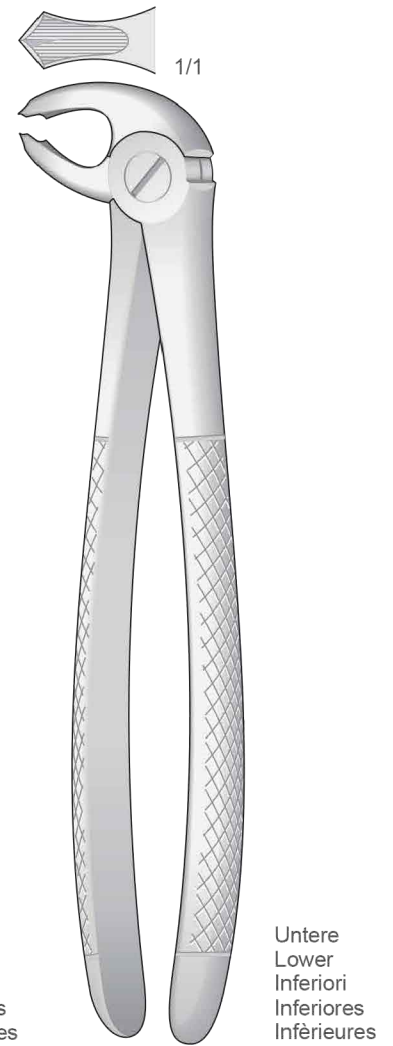
MEAD  
TM-MD-1



MEAD  
TM-MD-3



MEAD  
TM-MD-2



MEAD  
TM-MD-4

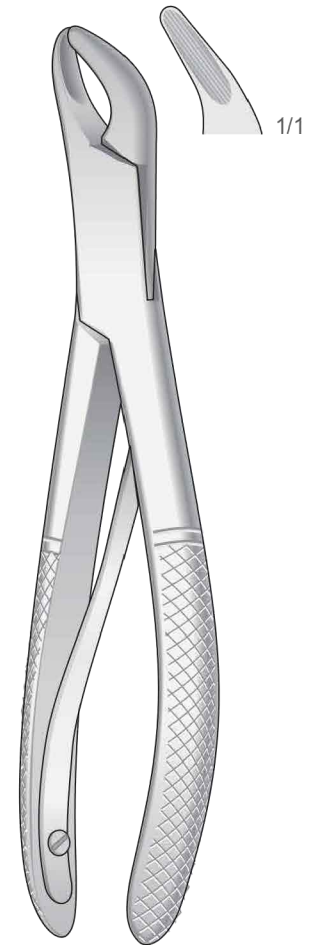
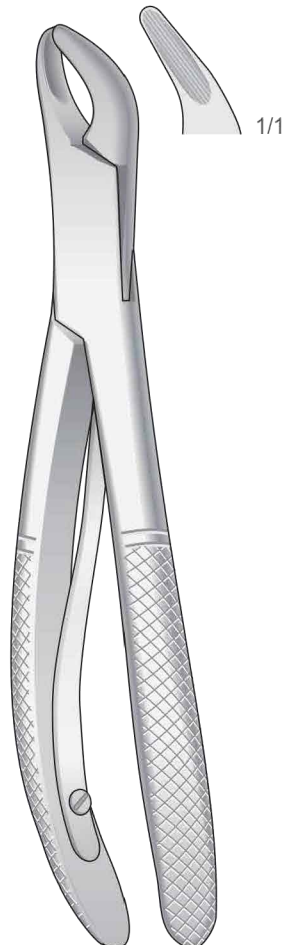
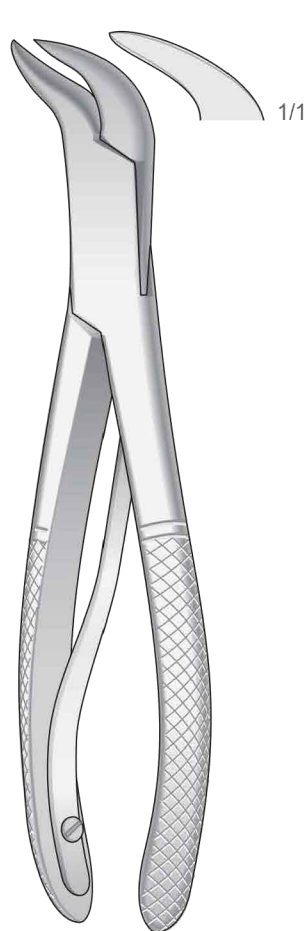
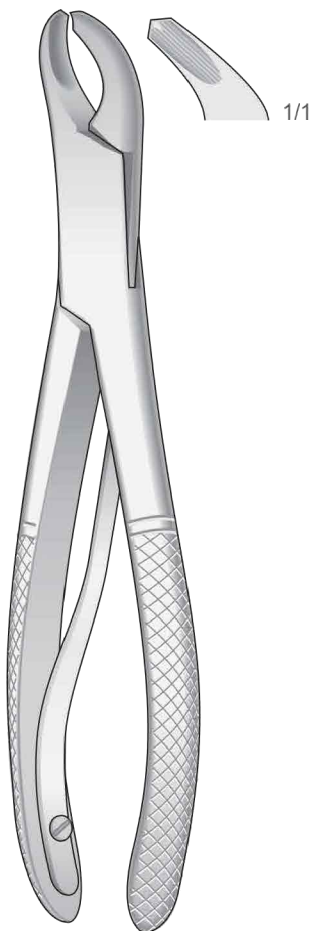
Kinderzahnzangen, Amerikanische Form  
 Extracting Forceps for children, American Pattern  
 Pinze per estrazione per bambini, Forma Americana  
 Forceps dentales para niños, Forma Americana  
 Daviers pour enfants, Forme Américaine

Molaren  
 Pedo Lower Molars  
 Molari  
 Molares  
 Molaires

Molaren  
 Pedo Lower Molars  
 Molari  
 Molares  
 Molaires

Zähne und wurzeln  
 Pedo upper incisors  
 Bicuspids and roots  
 Denti e radici  
 Dientes y raíces  
 Dentés et racines

Zähne und wurzeln  
 Pedo lower incisors  
 Bicuspids and roots  
 Denti e radici  
 Dientes y raíces  
 Dentés et racines



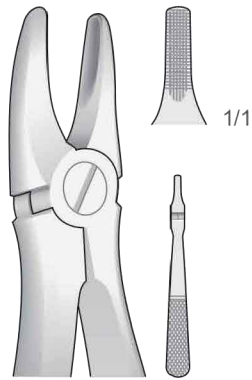
TM-PEB-175  
 Fig. 17SK

TM-PEB-235  
 Fig. 23SK

TM-PEB-150S  
 Fig. 150SK

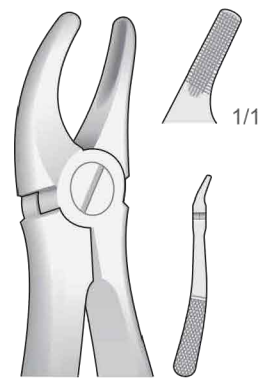
TM-PEB-151S  
 Fig. 151SK

Kinderzahnzangen  
Extracting Forceps for children  
Pinze per estrazione per bambini  
Forceps dentales para niños  
Daviers pour enfants



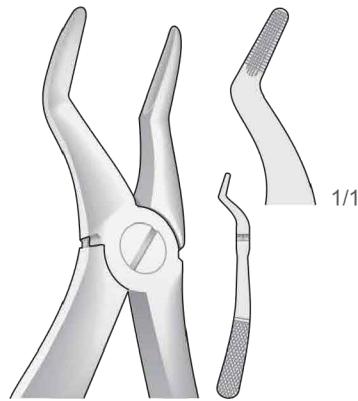
TM-PEB-1  
Fig. 137

Obere Schneidezähne  
Upper Incisors  
Incisivi superiori  
Incisivos superiores  
Incisives supérieures



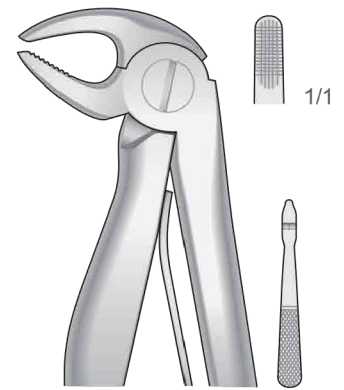
TM-PEB-2  
Fig. 139

Obere Prämolaren  
Upper Premolars  
Premolari superiori  
Premolares superiores  
Prémolaires supérieures



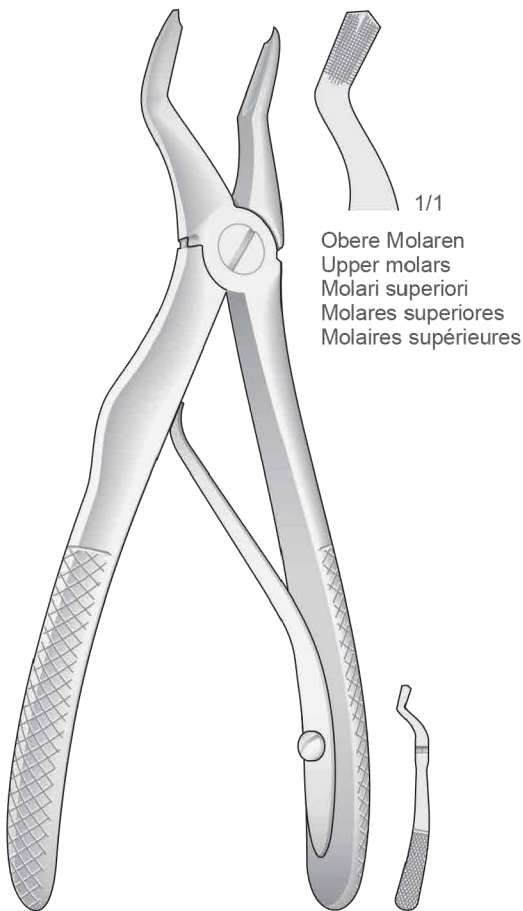
TM-PEB-4  
Fig. 51S

Obere Wurzeln  
Upper roots  
Radici superiori  
Raíces superiores  
Racines supérieures



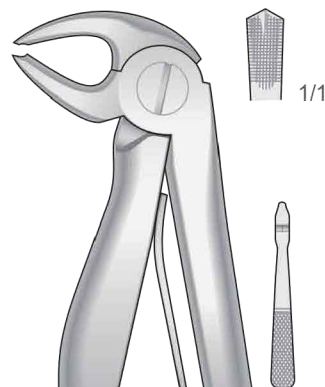
TM-PEB-5  
Fig. 5

Untere Schneidezähne  
Lower incisors  
Incisivi inferiori  
Incisivos inferiores  
Incisives inférieures



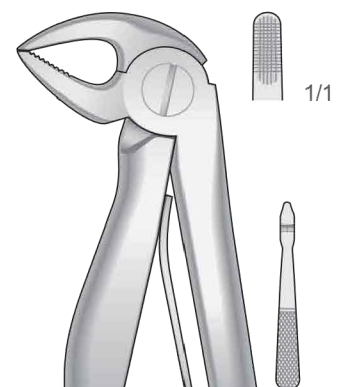
TM-PEB-3

Obere Molaren  
Upper molars  
Molari superiori  
Molares superiores  
Molaires supérieures



TM-PEB-6  
Fig. 6

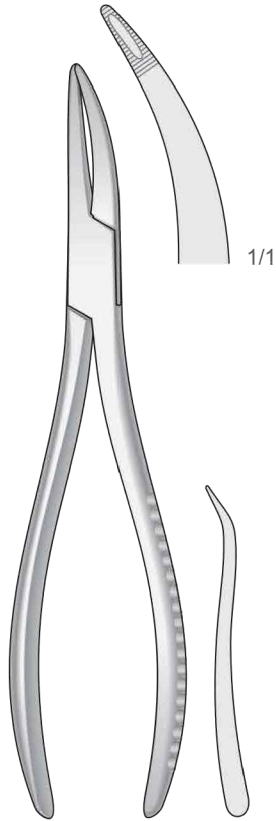
Untere Molaren  
Lower Molars  
Molari inferiori  
Molares inferiores  
Molaires inférieures



TM-PEB-7  
Fig. 7

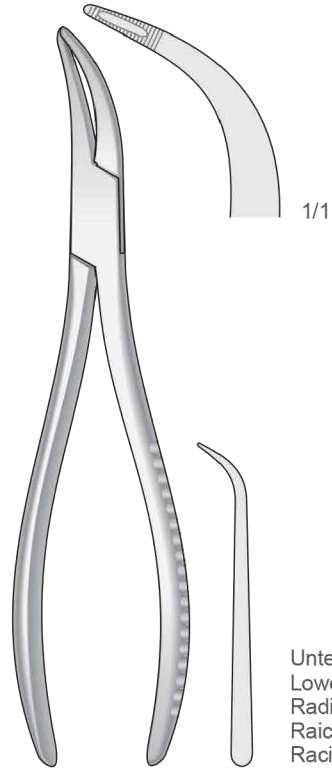
Untere Wurzeln  
Lower roots  
Radici inferiori  
Raíces inferiores  
Racines inférieures





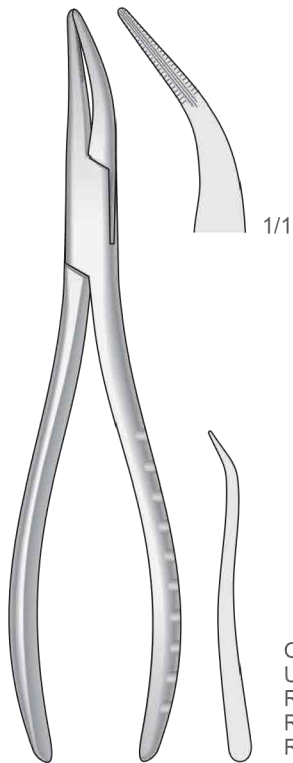
Obere Wurzeln, Universal  
Upper roots, Universal  
Radici superiori, Universale  
Raices superiores, Universal  
Racines superieures, Universel

WITZEL  
TM-DK-26  
170 mm



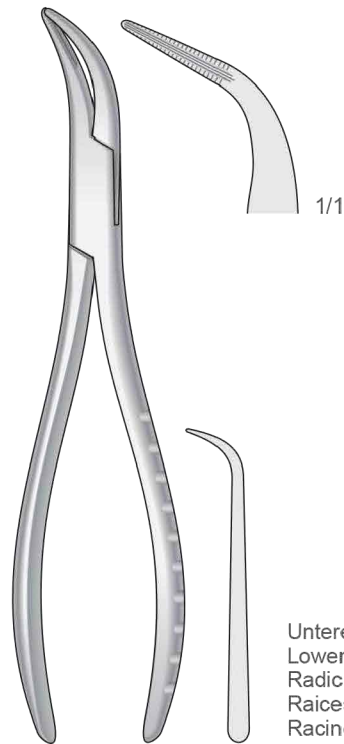
Untere Wurzeln, Universal  
Lower roots, Universal  
Radici inferiori, Universale  
Raices inferiores, Universal  
Racines inferieures, Universel

WITZEL  
TM-DK-28  
165 mm



Obere Wurzeln, Universal  
Upper roots, Universal  
Radici superiori, Universale  
Raices superiores, Universal  
Racines superieures, Universel

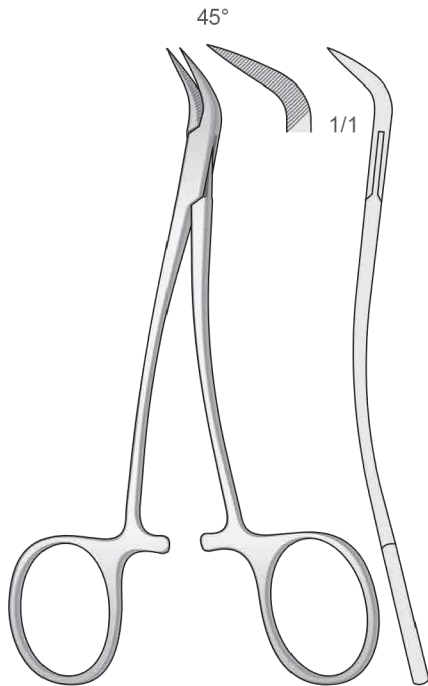
TM-400 (300)  
165 mm



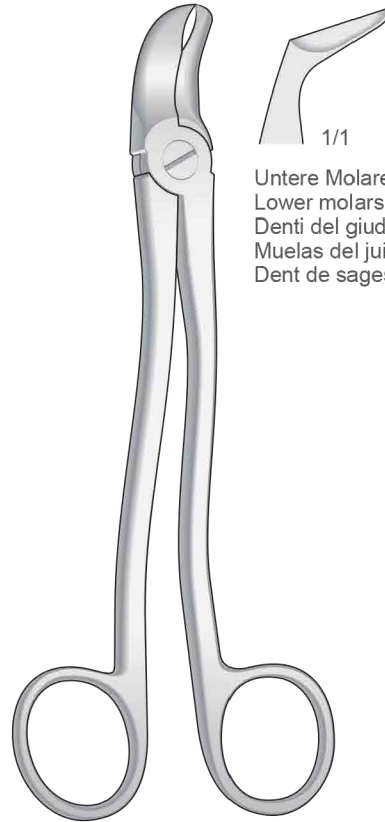
Untere Wurzeln, Universal  
Lower roots, Universal  
Radici inferiori, Universale  
Raices inferiores, Universal  
Racines inferieures, Universel

TM-401 (301)  
160 mm

Wurzelfragmentinstrumente  
Root Fragment Forceps  
Strumenti per frammenti di radici  
Instrumentos para fragmentos de raíces  
Instruments pour fragments de racines



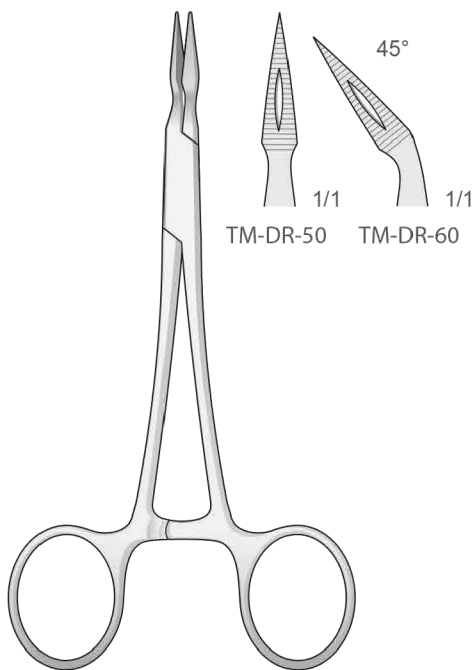
PEET  
TM-DR-40  
120 mm



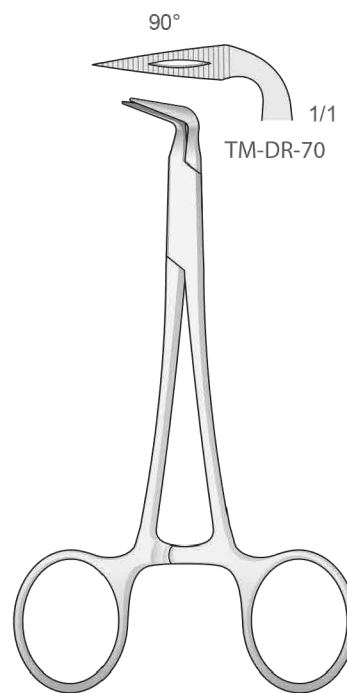
1/1  
Untere Molaren und Weisheitszähne  
Lower molars and wisdom teeth  
Denti del giudizio e molari inferiori  
Muelas del juicio y molares inferiores  
Dent de sagesse et molaires inférieures

TM-RO-1  
175 mm

Wurzelfragmente  
Root fragments  
Frammenti di radici  
Fragmentos de raíces  
Fragments de racines

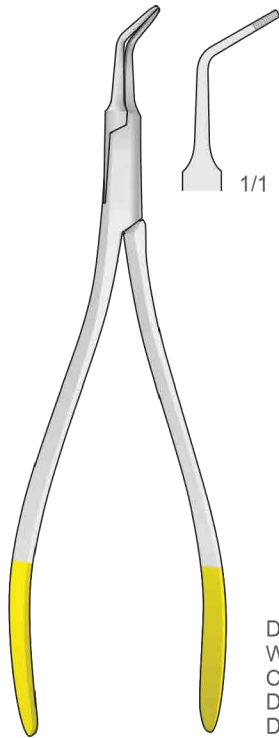


STIEGLITZ  
TM-DR-50/TM-DR-60  
140 mm



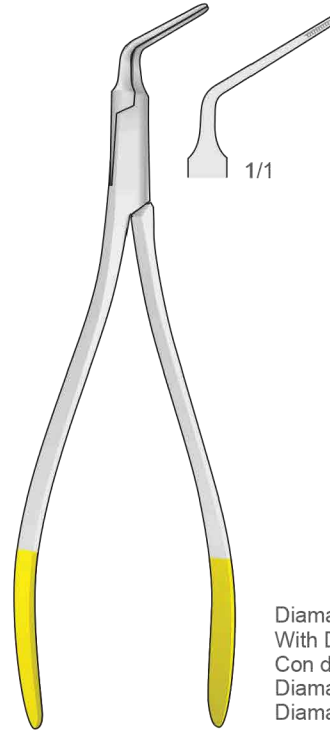
STIEGLITZ  
TM-DR-70  
120 mm

Wurzelfragmentinstrumente  
Root Fragment Forceps  
Strumenti per frammenti di radici  
Instrumentos para fragmentos de raíces  
Instruments pour fragments de racines



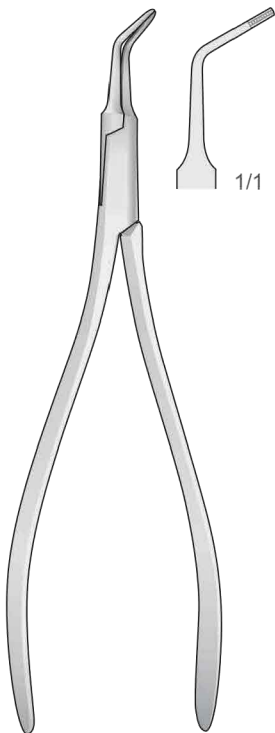
Diamantiert  
With Diamond  
Con diamante  
Diamantada  
Diamantées

TM-DA-01M  
130 mm

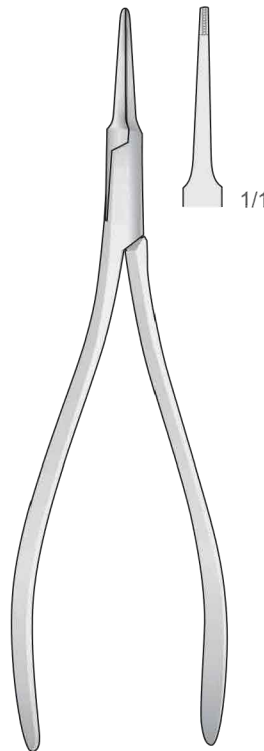


Diamantiert  
With Diamond  
Con diamante  
Diamantada  
Diamantées

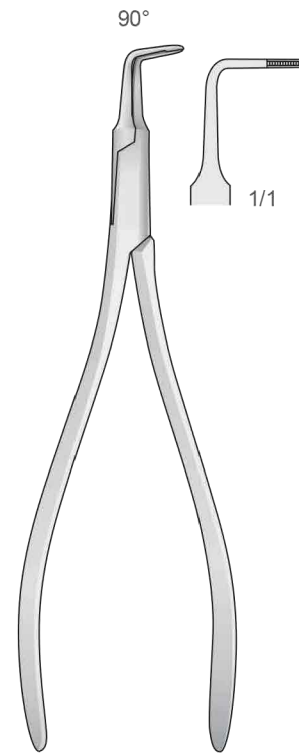
TM-DA-10  
130 mm



TM-DA-01  
130 mm



TM-DA-02  
130 mm

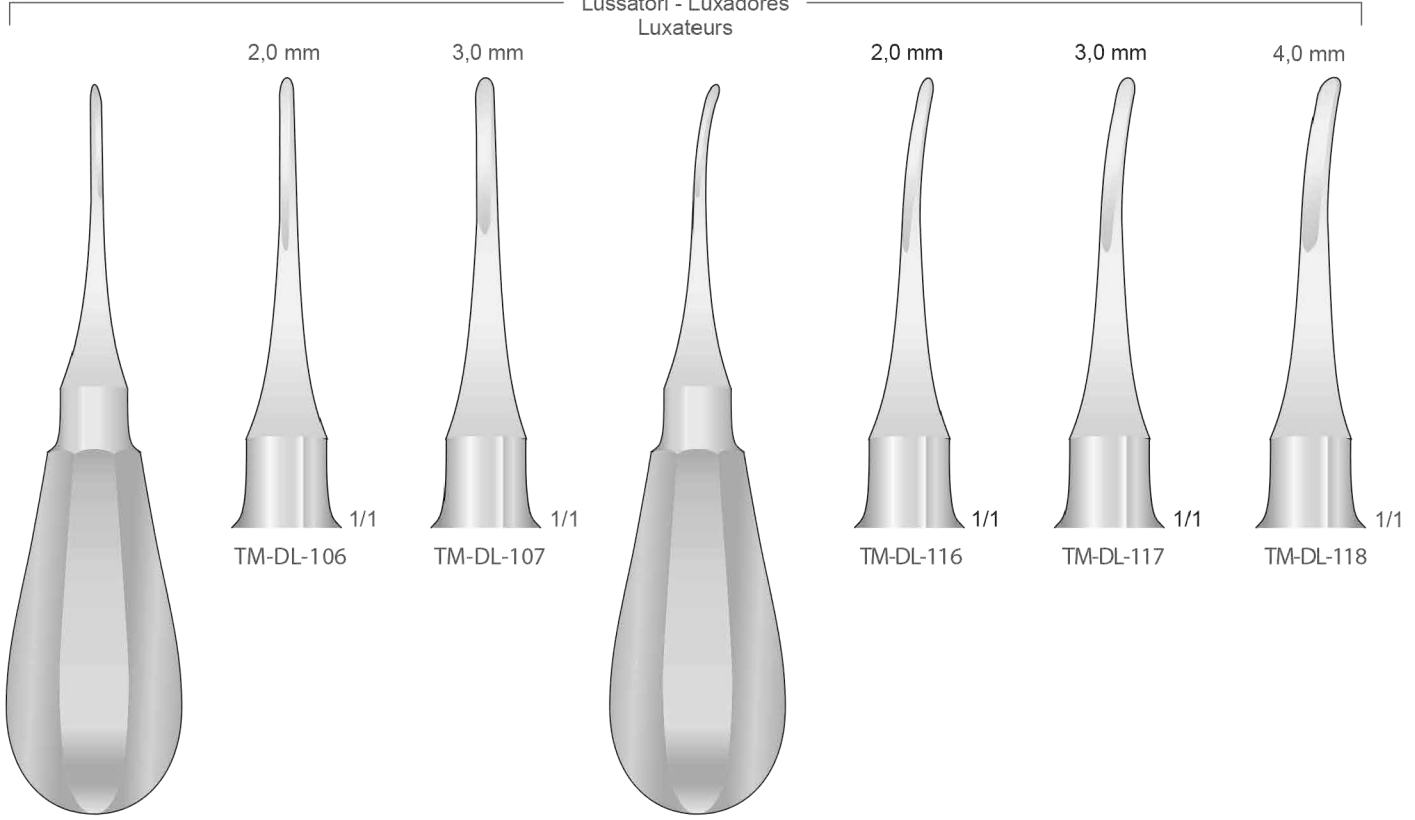


TM-DA-03  
125 mm

Wurzelheber  
Root Elevators  
Leve per radici  
Elevadores para raíces  
Elevateurs à racines

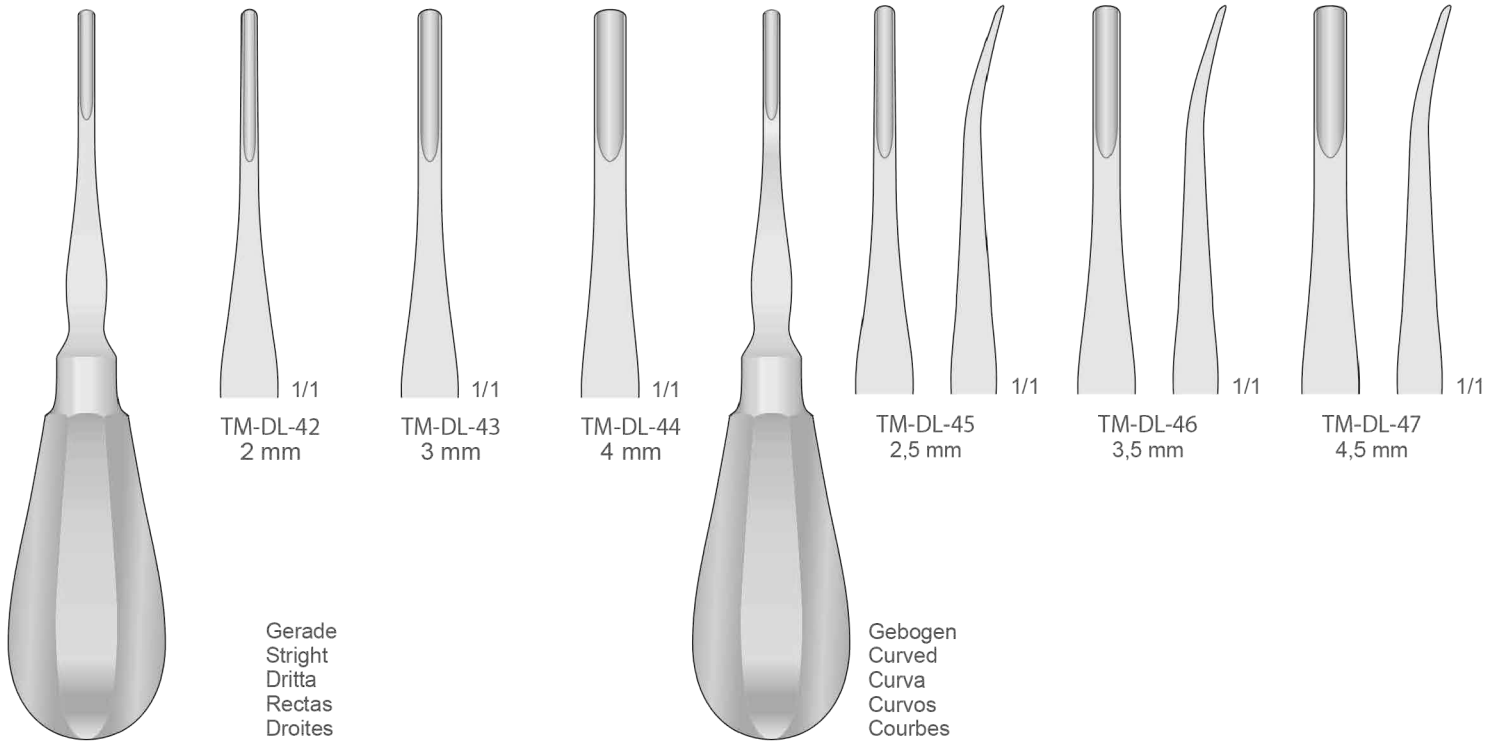
SMALL HANDLE

Luxatoren - Luxators  
Lussatori - Luxadores  
Luxateurs



TM-DL-106/TM-DL-107  
120 mm

TM-DL-116/TM-DL-118  
120 mm



Gerade  
Stright  
Dritta  
Rectas  
Droites

Gebogen  
Curved  
Curva  
Curvos  
Courbes

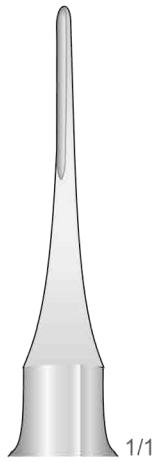
BEIN  
TM-DL-42/TM-DL-44

W



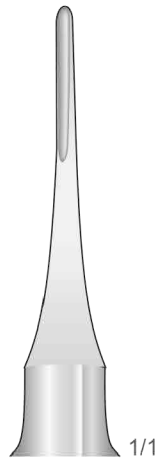
TM-DL-81/TM-DL-87  
150 mm

2,0 mm



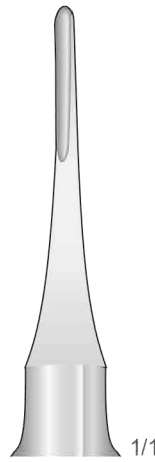
TM-DL-81  
150 mm

2,5 mm



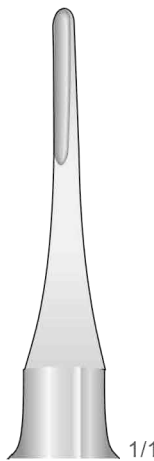
TM-DL-82  
150 mm

3,0 mm



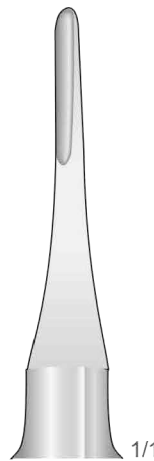
TM-DL-83  
150 mm

3,5 mm



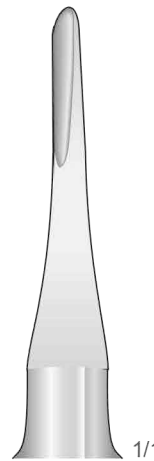
TM-DL-84  
150 mm

4,0 mm



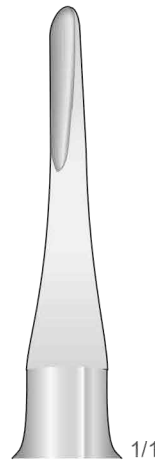
TM-DL-85  
150 mm

4,5 mm



TM-DL-86  
150 mm

5,0 mm



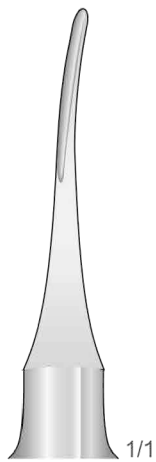
TM-DL-87  
150 mm

Wurzelheber  
Root Elevators  
Leve per radici  
Elevadores para raíces  
Elevateurs à racines



TM-DL-91/TM-DL-97  
150 mm

2,0 mm



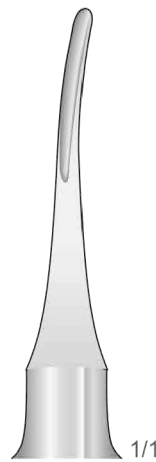
TM-DL-91  
150 mm

2,5 mm



TM-DL-92  
150 mm

3,0 mm



TM-DL-93  
150 mm

3,5 mm



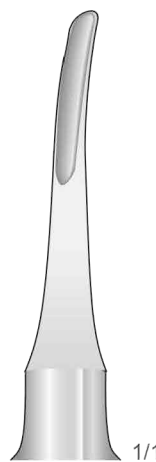
TM-DL-94  
150 mm

4,0 mm



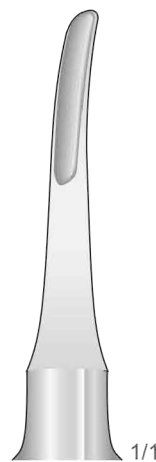
TM-DL-95  
150 mm

4,5 mm



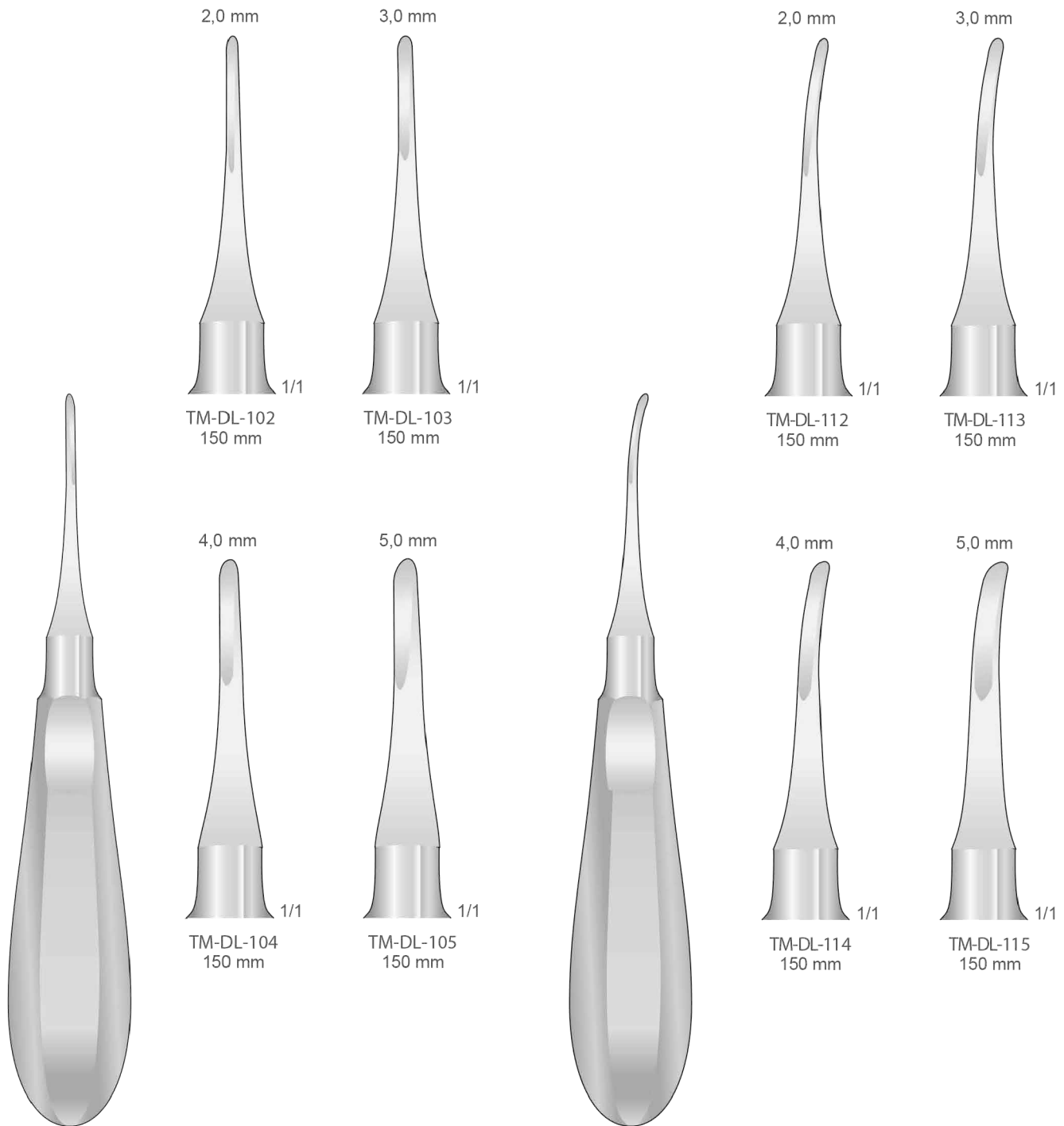
TM-DL-96  
150 mm

5,0 mm



TM-DL-97  
150 mm

Luxatoren  
Luxators  
Lussatori  
Luxadores  
Luxateurs



TM-DL-102/TM-DL-105  
150 mm

TM-DL-112/TM-DL-115  
150 mm

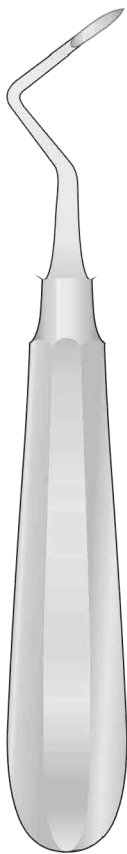
Wurzelheber  
Root Elevators  
Leve per radici  
Elevadores para raíces  
Elevateurs à racines

Wurzelspitzenheber  
Root fragment Elevators  
Leve per frammenti di radice  
Elevadores para fragmentos de raíces  
Elévateurs de fragments de racines

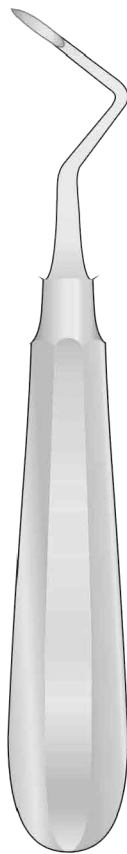
Gezahnt  
Serrated  
Dentellata  
Dentada  
Dentelé



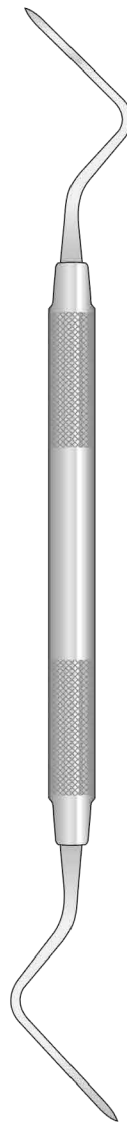
HEIDBRINK  
TM-HE-1  
140 mm



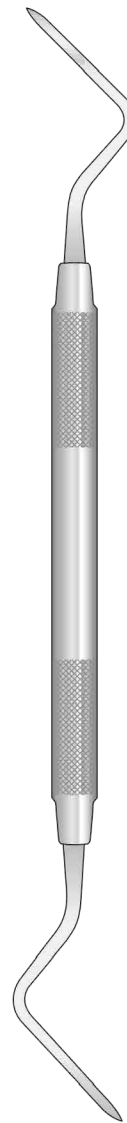
HEIDBRINK  
TM-HE-2  
140 mm



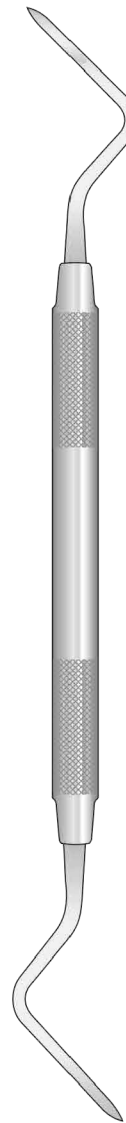
HEIDBRINK  
TM-HE-3  
140 mm



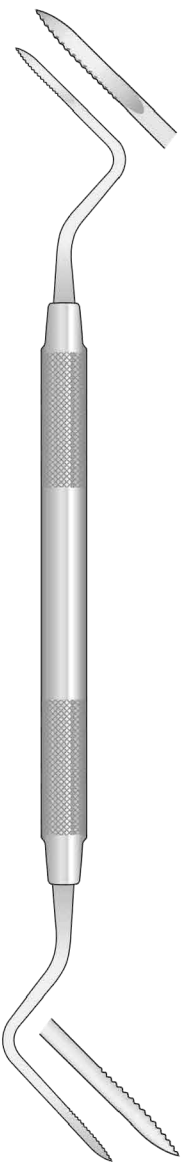
HEIDBRINK  
TM-725-1/2  
195 mm



HEIDBRINK  
TM-725-3/4  
195 mm



HEIDBRINK  
TM-725-5/6  
195 mm

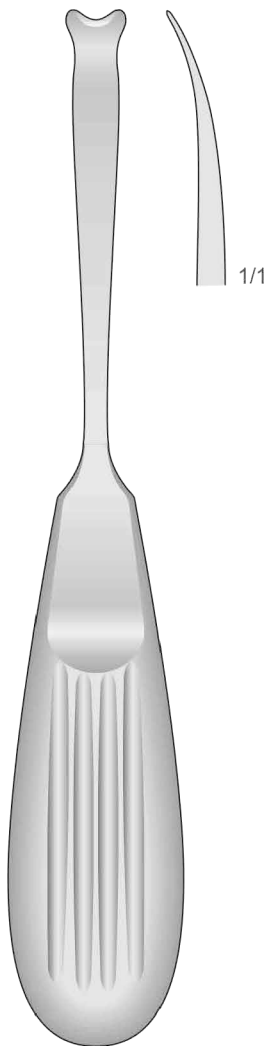


HEIDBRINK  
TM-725-3/4S  
195 mm



Extraktionshebel für obere Weisheitszähne  
Luxator for upper wisdom teeth  
Leva per estrazione dente del giudizio superiore  
Elevador de extracción de muelas del juicio superiores  
Levier d'extraction pour dent de sagesse supérieures

Wurzelheber  
Root Elevators  
Leve per radici  
Elevadores para raíces  
Élevateurs de racines



ROSIN  
TM-DL-58  
160 mm



WARWICK-JAMES  
TM-DL-20  
160 mm



WARWICK-JAMES  
TM-DL-21  
155 mm



WARWICK-JAMES  
TM-DL-22  
155 mm

Obere  
Upper  
Superiori  
Superiores  
Supérieures

Untere  
Lower  
Inferiori  
Inferiores  
Inférieures

Untere  
Lower  
Inferiori  
Inferiores  
Inférieures

Wurzelheber  
Root Elevators  
Leve per radici  
Elevadores para raíces  
Elevateurs à racines

Eine seite gezahnt  
One side serrated  
Un lato dentellato  
Dentadura más lado  
Dentelure sur un côté

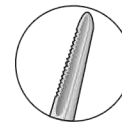
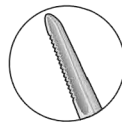


Fig. 94



TM-DL-76  
155 mm

Fig. 95



TM-DL-77  
155 mm

Fig. 100L



TM-DL-78  
155 mm

Fig. 100R



TM-DL-79  
155 mm

Gezahnt  
Serrated  
Dentellate  
Dentadas  
Dentelé

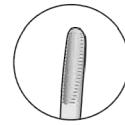
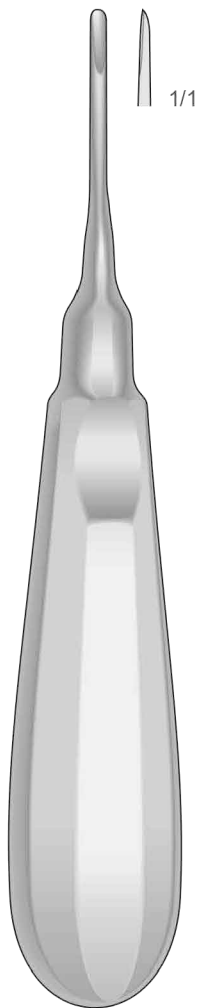
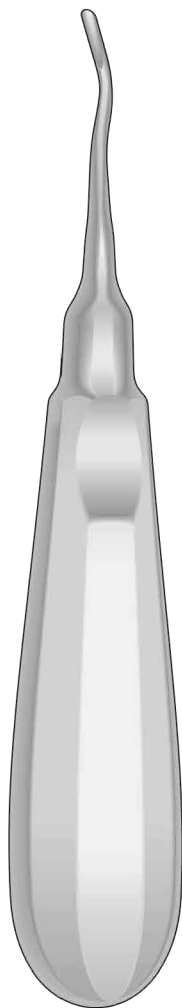


Fig. 301



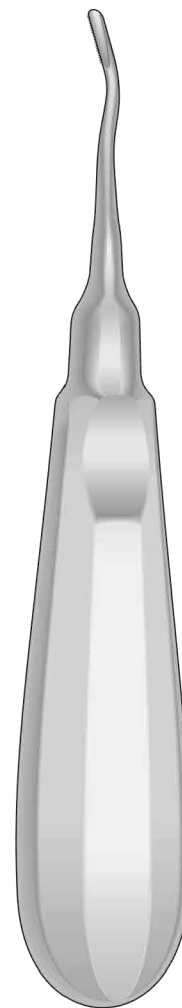
APEXO  
TM-DL-34  
160 mm

Fig. 302



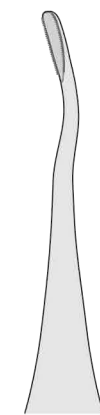
APEXO  
TM-DL-35/TM-DL-36  
160 mm

Fig. 303



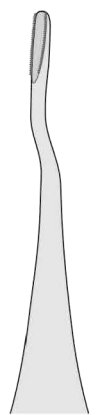
APEXO  
TM-DL-37/TM-DL-38  
160 mm

Fig. 77L



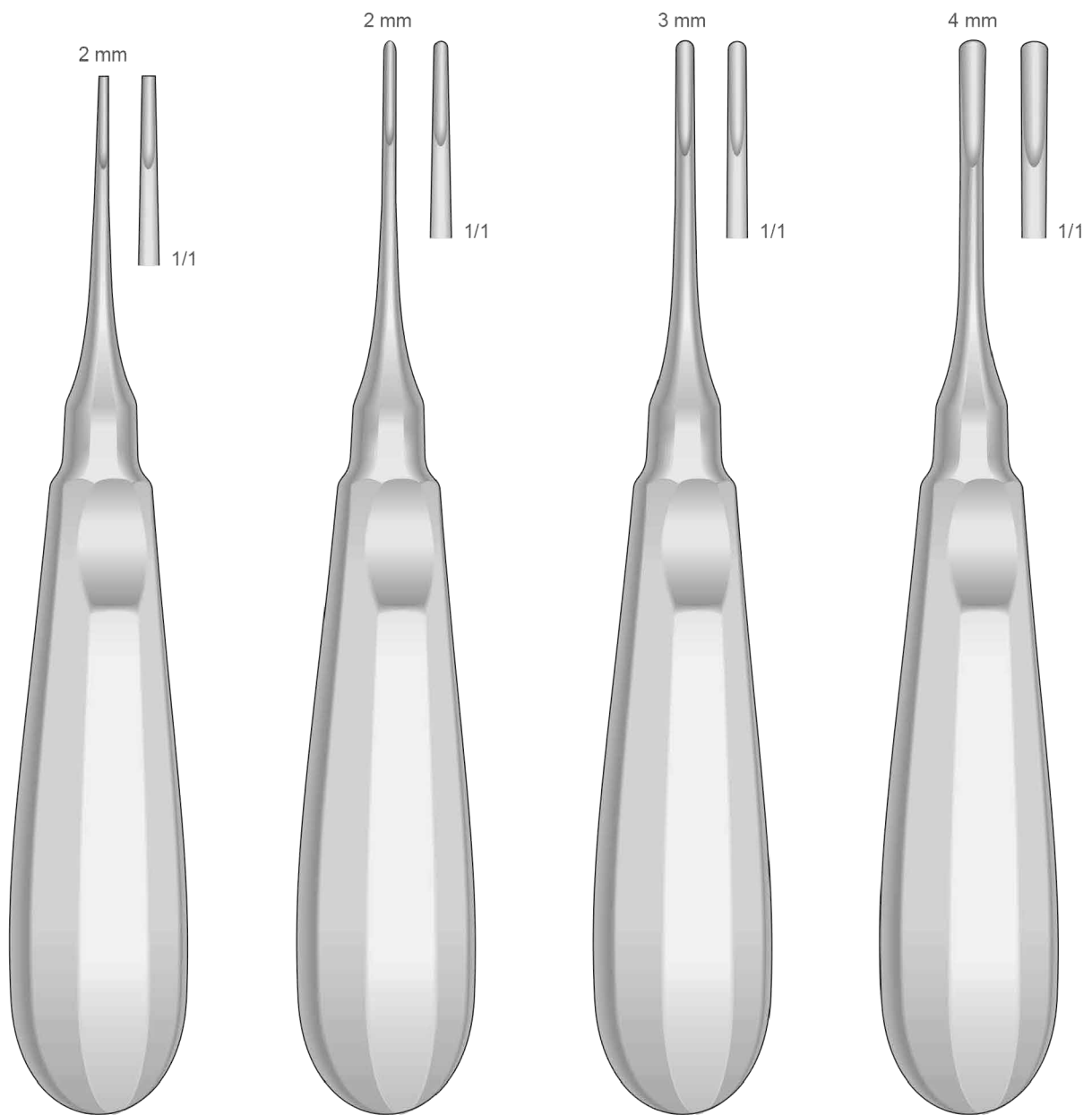
TM-DL-37

Fig. 77R



TM-DL-38

Wurzelheber  
Root Elevators  
Leve per radici  
Elevadores para raíces  
Elevateurs à racines

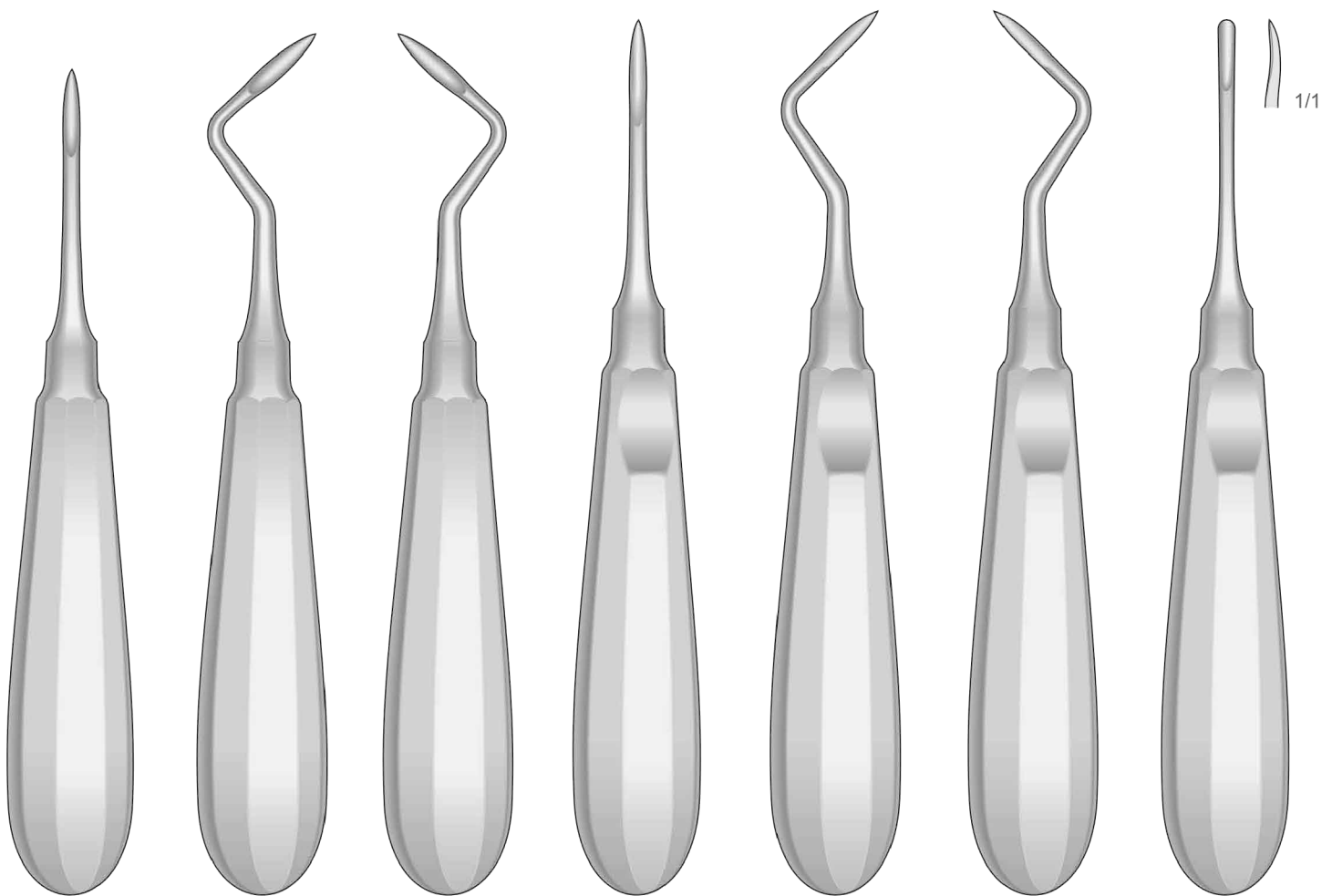


TM-BEIN-1T  
150 mm

TM-BEIN-2  
155 mm

TM-BEIN-3  
155 mm

TM-BEIN-4  
155 mm



TM-FLOHR-1  
140 mm

TM-FLOHR-2  
150 mm

TM-FLOHR-3  
150 mm

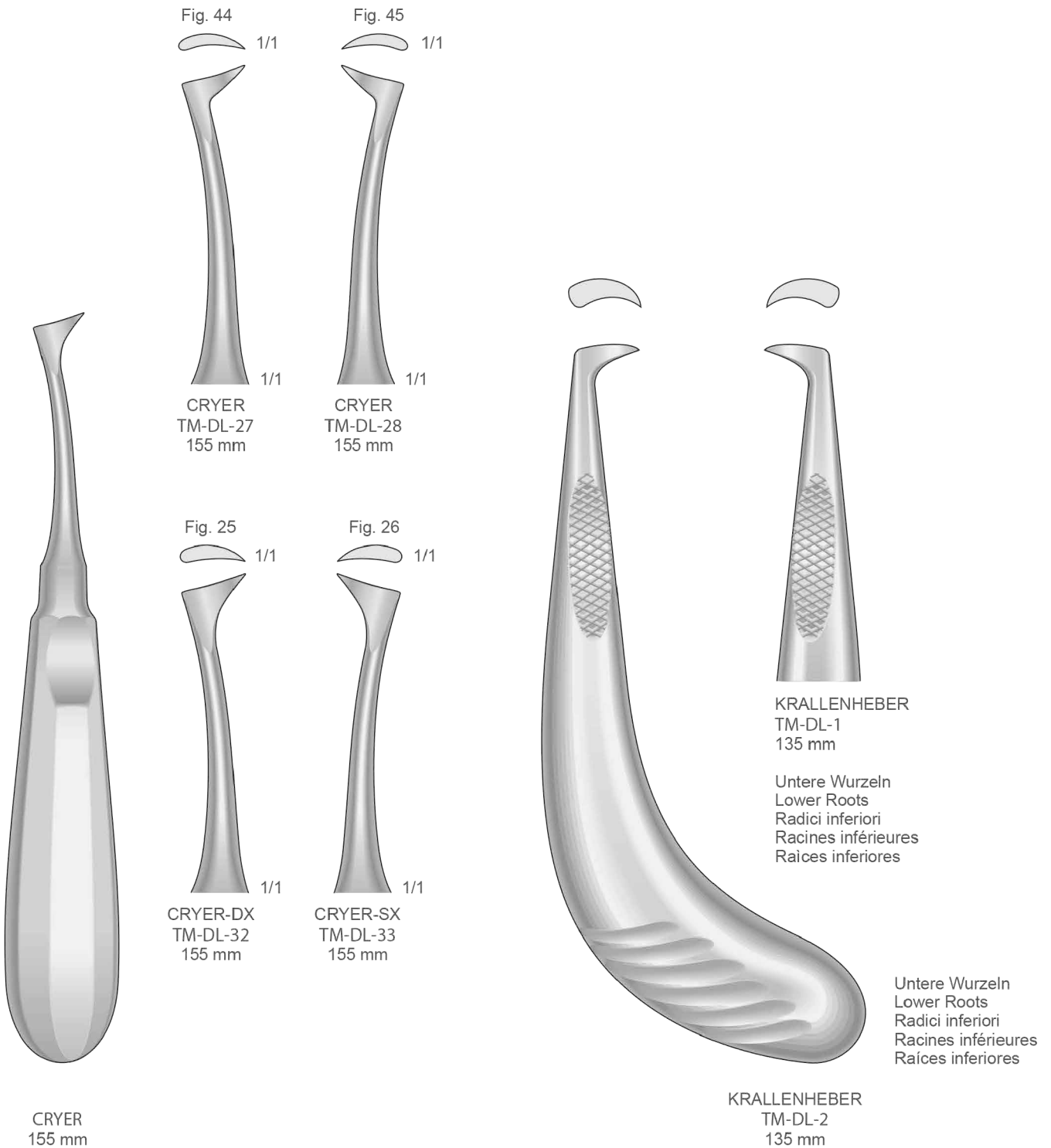
TM-APICAL-1  
155 mm

TM-APICAL-2  
155 mm

TM-APICAL-3  
155 mm

TM-APICAL-4  
155 mm

Wurzelheber  
Root Elevators  
Leve per radici  
Elevadores para raíces  
Elevateurs à racines



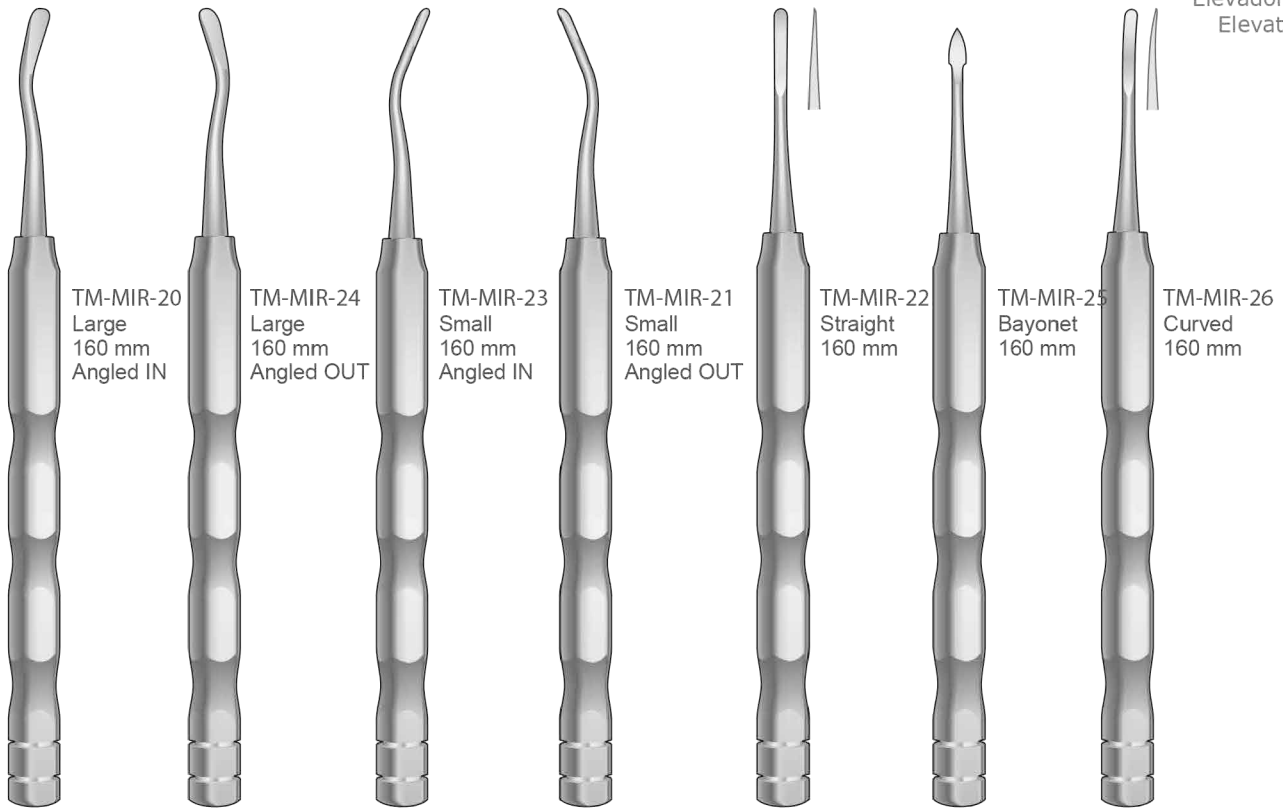


Fig. 1  
2,0 mm

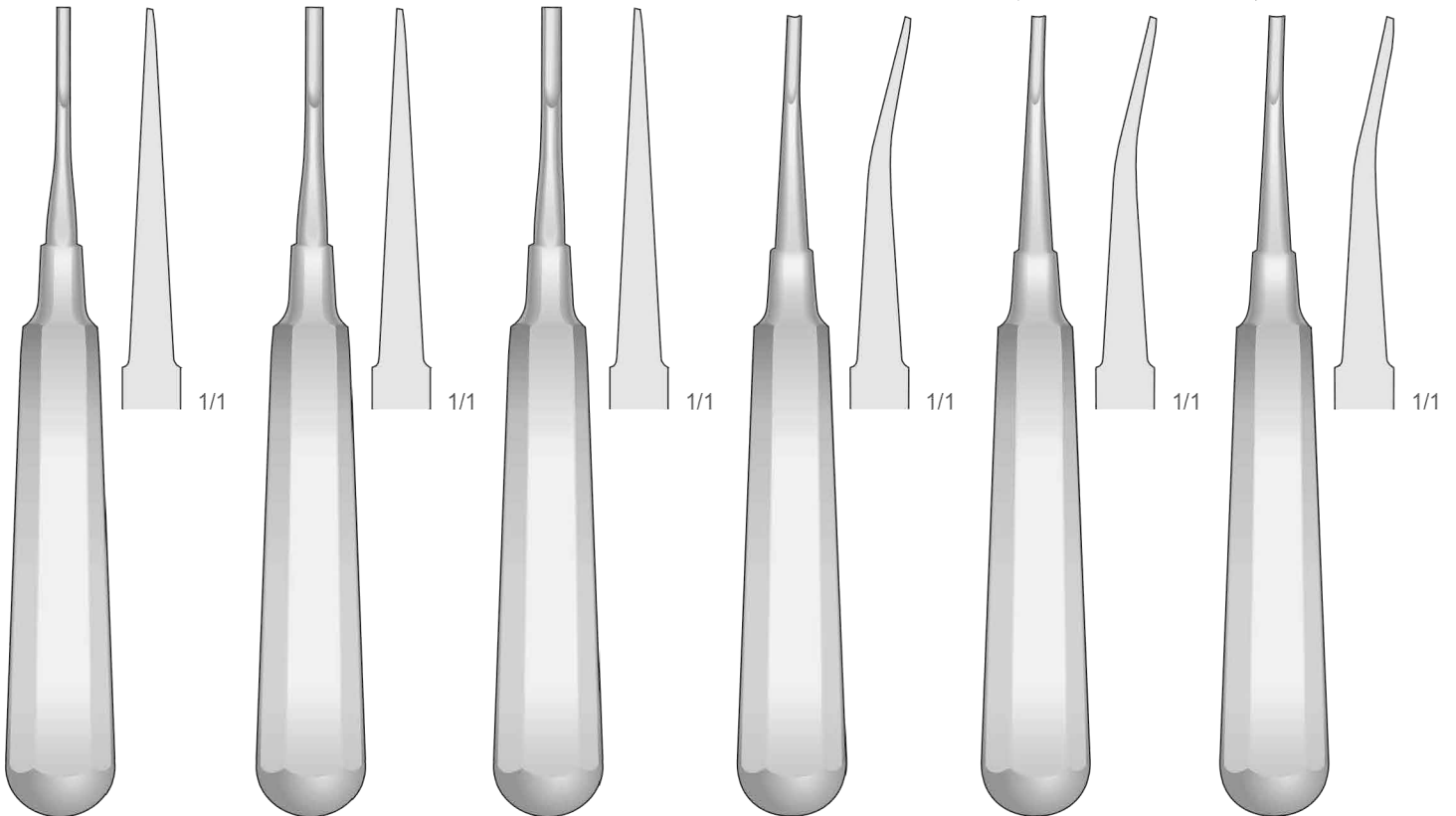
Fig. 2  
3,6 mm

Fig. 3  
4,2 mm

Fig. 1  
3,0 mm

Fig. 2  
3,6 mm

Fig. 3  
4,2 mm



COUPLAND  
TM-CO-1  
155 mm

COUPLAND  
TM-CO-2  
155 mm

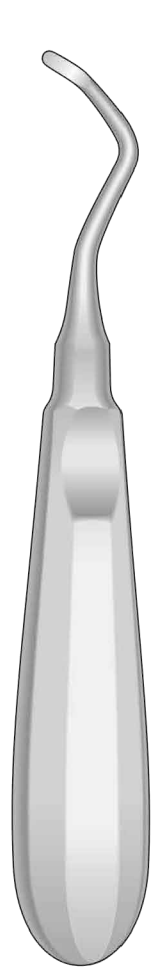
COUPLAND  
TM-CO-3  
155 mm

COUPLAND  
TM-CO-11  
155 mm

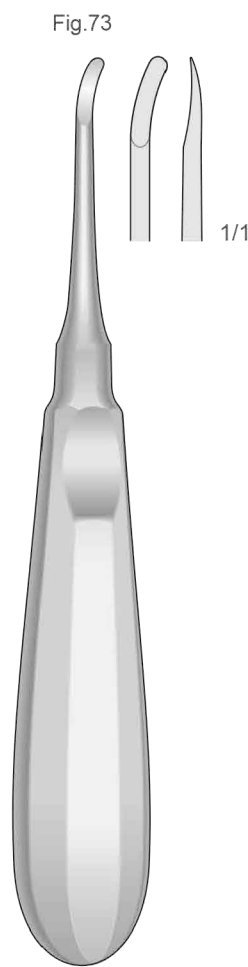
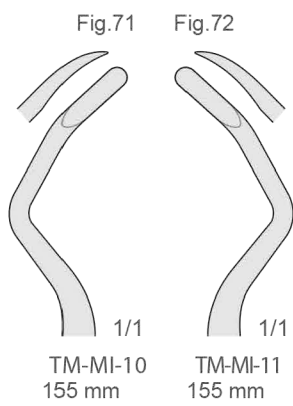
COUPLAND  
TM-CO-12  
155 mm

COUPLAND  
TM-CO-13  
155 mm

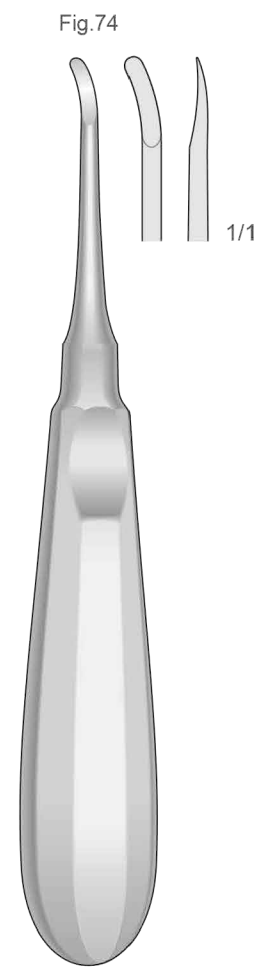
Wurzelheber  
Root Elevators  
Leve per radici  
Elevadores para raíces  
Elevateurs à racines



MILLER-APEVO  
TM-MI-10/TM-MI-11  
155 mm

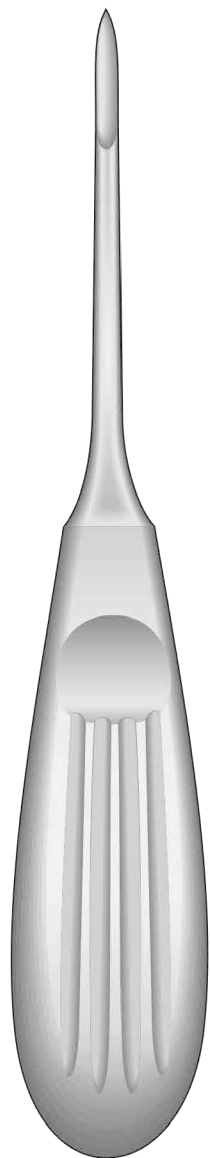


MILLER-APEVO  
TM-MI-12  
155 mm



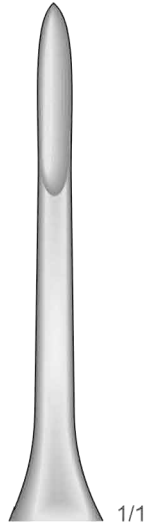
MILLER-APEVO  
TM-MI-13  
155 mm





HYLIN  
TM-DL-11/TM-DL-19  
145 mm

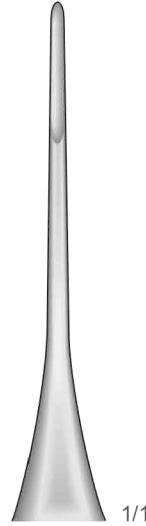
4 mm



1/1

HYLIN  
TM-DL-11  
145 mm

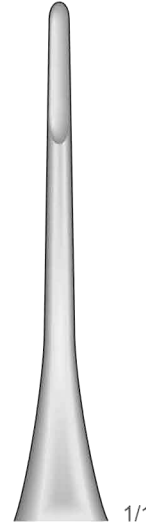
2 mm



1/1

HYLIN-2C  
TM-DL-13  
145 mm

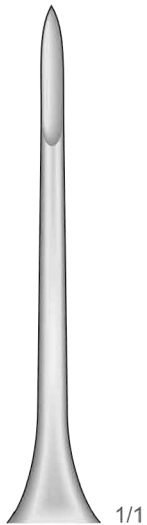
3 mm



1/1

HYLIN-3C  
TM-DL-14  
145 mm

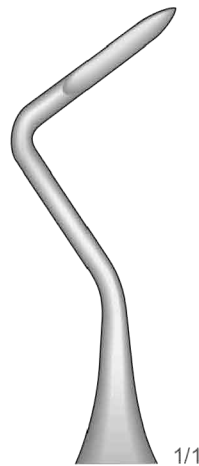
3 mm



1/1

HYLIN-1  
TM-DL-17  
145 mm

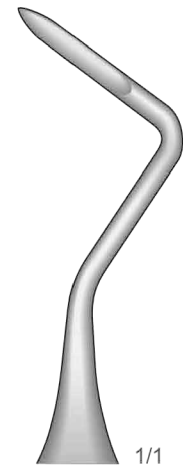
3 mm



1/1

HYLIN-2  
TM-DL-18  
145 mm

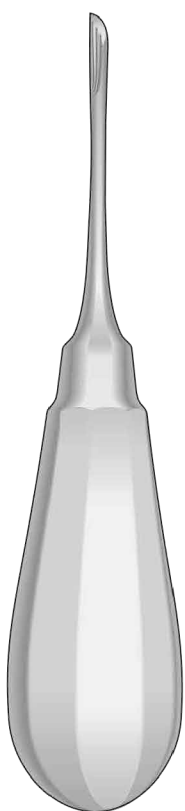
3 mm



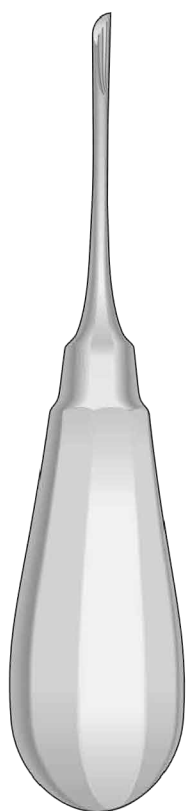
1/1

HYLIN-3  
TM-DL-19  
145 mm

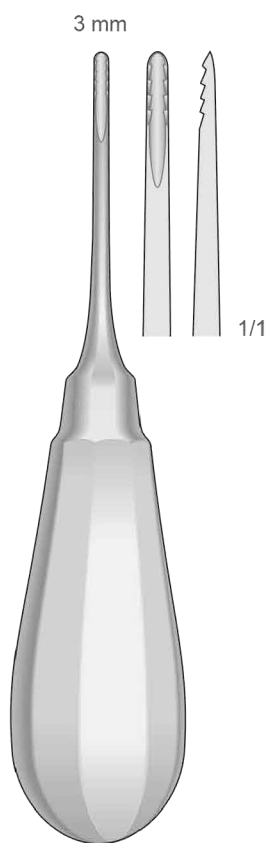
Wurzelheber  
Root Elevators  
Leve per radici  
Elevadores para raíces  
Elevateurs à racines



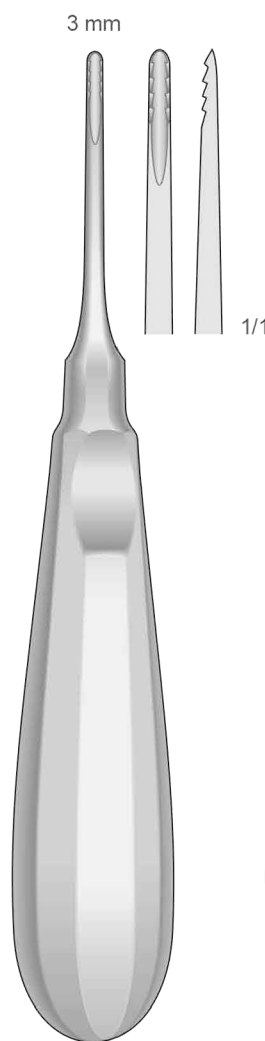
KOPP  
TM-DL-30  
130 mm



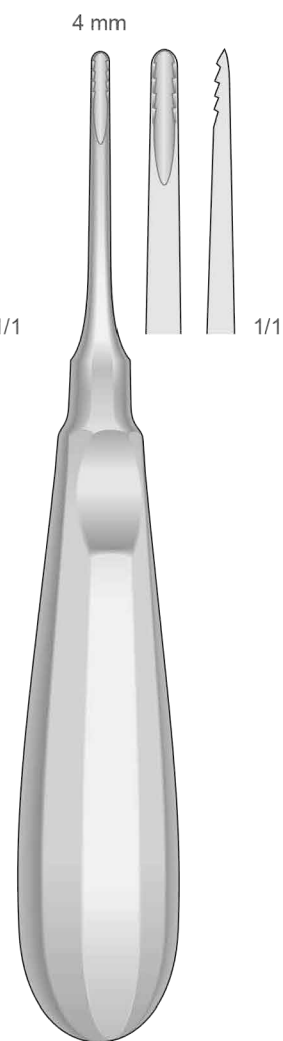
KOPP  
TM-DL-31  
130 mm



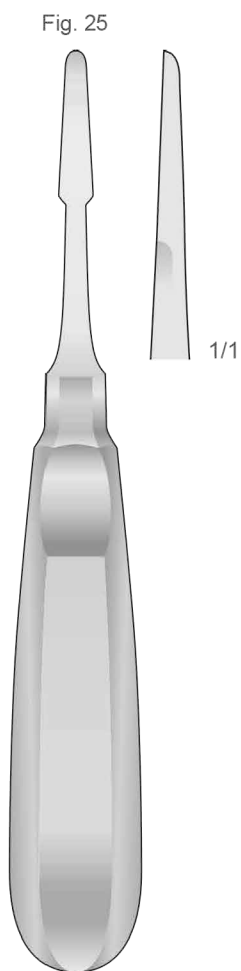
TM-BEIN-1Z  
130 mm



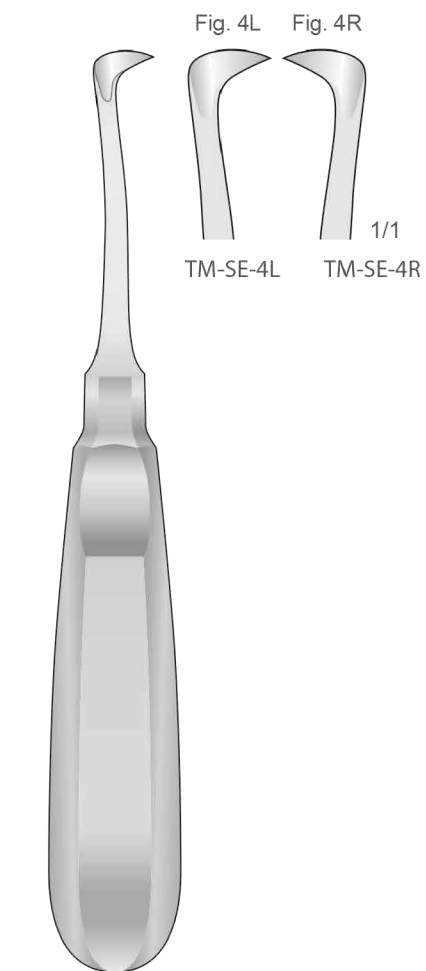
TM-BEIN-2Z  
155 mm



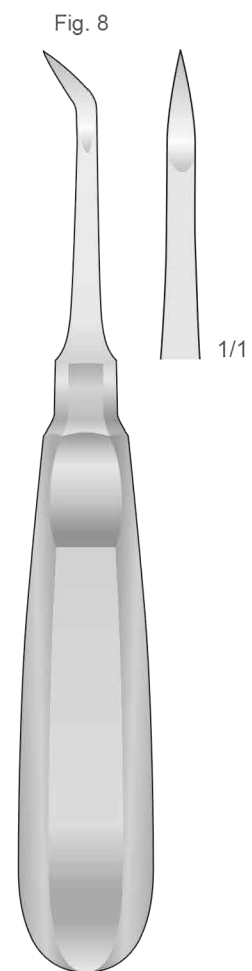
LINDO-LEVIEN  
TM-BEIN-4Z  
155 mm



SELDIN  
TM-SE-2  
160 mm



SELDIN  
TM-SE-4L/TM-SE-4R  
160 mm



CRANE PICK  
TM-HP-6  
155 mm

Wurzelheber  
Root Elevators  
Leve per radici  
Elevadores para raíces  
Elevateurs à racines

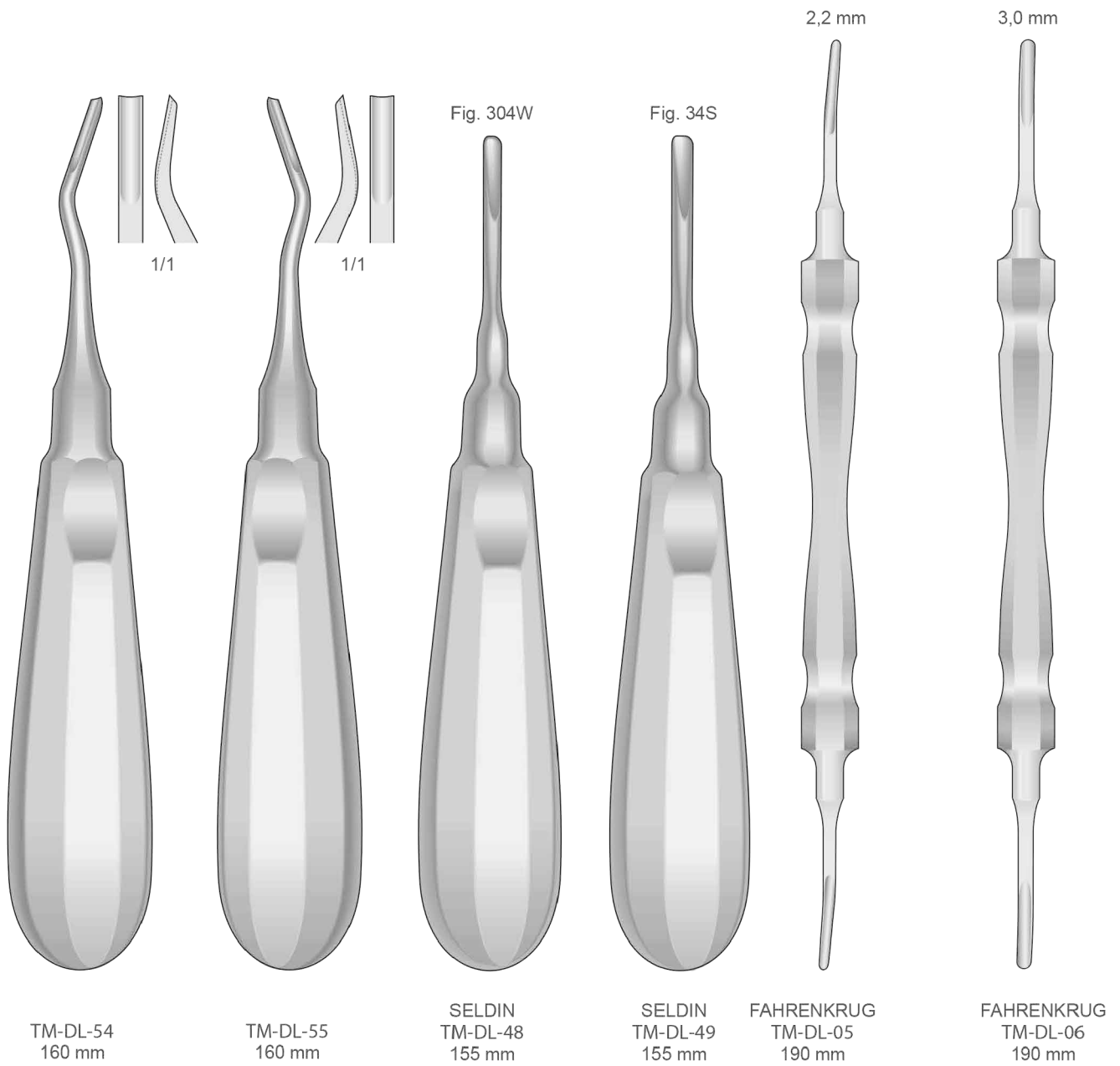
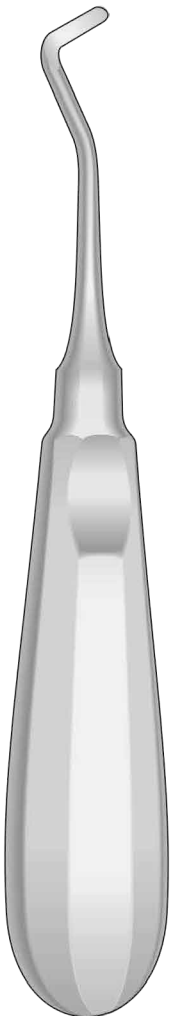
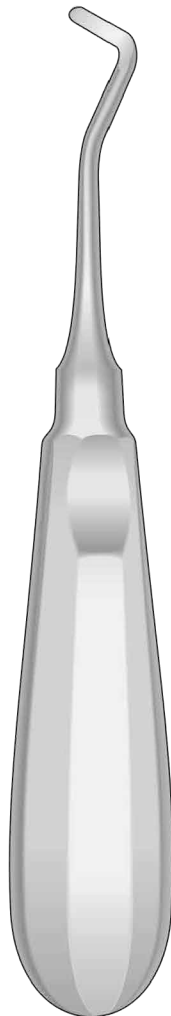


Fig. 6

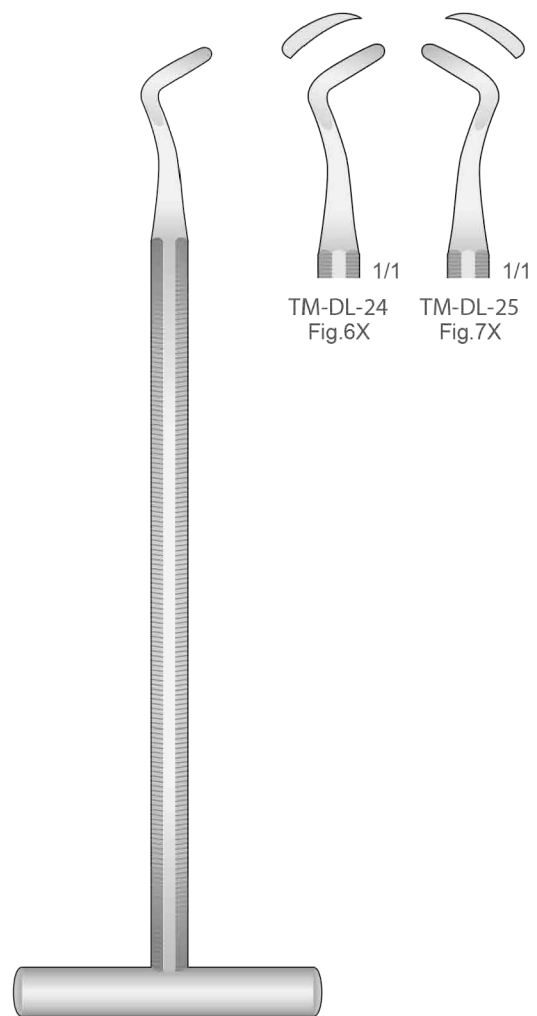


POTT  
TM-DL-98  
160 mm

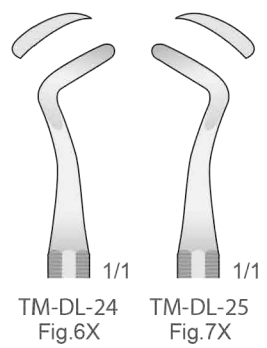
Fig. 7



POTT  
TM-DL-99  
160 mm



POTT  
TM-DL-24/TM-DL-25  
155 mm

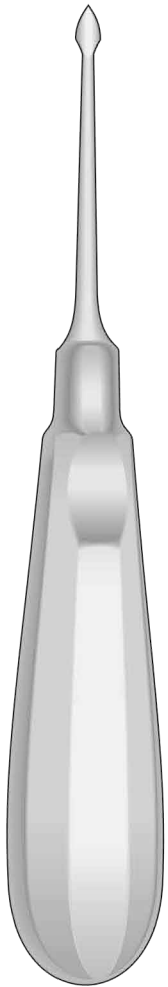


TM-DL-24  
Fig.6X

TM-DL-25  
Fig.7X

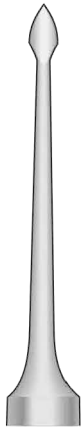
Wurzelheber  
Root Elevators  
Leve per radici  
Elevadores para raíces  
Elevateurs à racines

Syndesmotome  
Syndesmotomes  
Sindesmotomi  
Syndesmòtomos  
Syndesmotomes



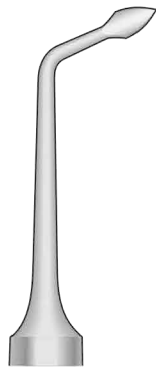
BERNARD  
TM-DL-73/TM-DL-124

Gerade  
Straight  
Diritto  
Rectas  
Droites



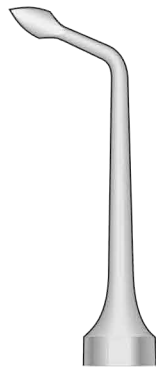
BERNARD  
TM-DL-73  
150 mm

Links  
Left  
Sinistra  
A la izquierda  
À gauche



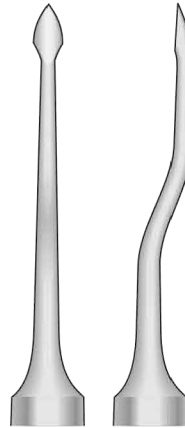
BERNARD  
TM-DL-74  
140 mm

Rechts  
Right  
Destro  
A la derecha  
À droite

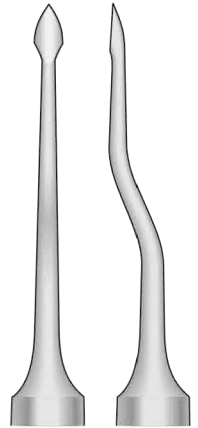


BERNARD  
TM-DL-75  
140 mm

Bajonett - Bayonet  
Baionetta - Bayoneta  
Baionnette

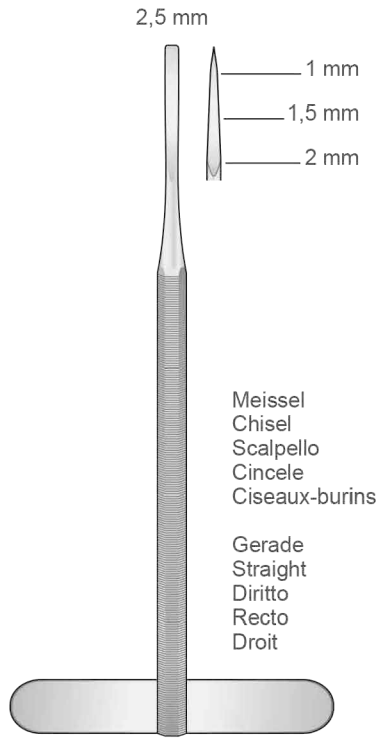


BERNARD  
TM-DL-123  
150 mm



BERNARD  
TM-DL-124  
150 mm

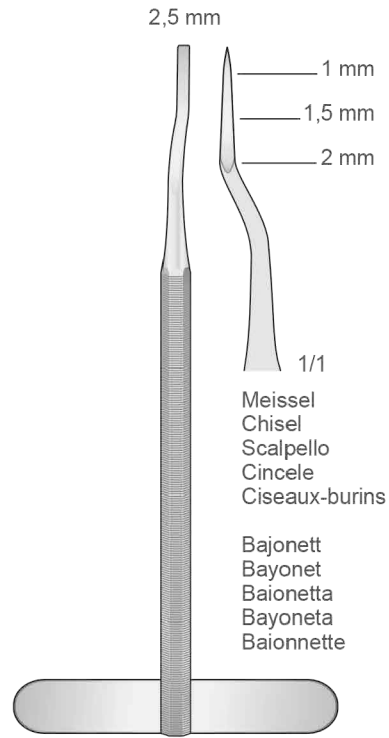
Wurzelheber  
Root Elevators  
Leve per radici  
Elevadores para raíces  
Elevateurs à racines



TM-DL-88  
130 mm

Meissel  
Chisel  
Scalpello  
Cincele  
Ciseaux-burins

Gerade  
Straight  
Diritto  
Recto  
Droit



TM-DL-89  
130 mm

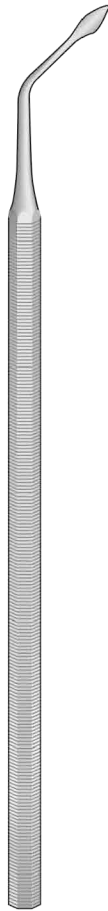
Meissel  
Chisel  
Scalpello  
Cincele  
Ciseaux-burins

Bajonett  
Bayonet  
Baionetta  
Bayoneta  
Baionnette

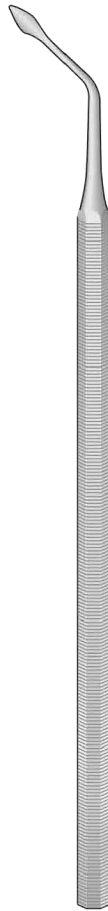
Syndesmotome  
Syndesmotomes  
Sindesmotomo  
Syndesmôtomos  
Syndesmotomes



TM-DL-63  
158 mm



TM-DL-62  
152 mm

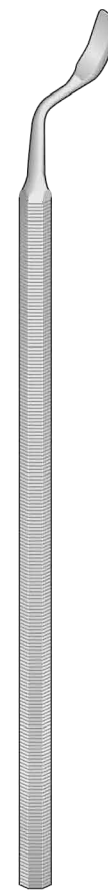


TM-DL-61  
152 mm

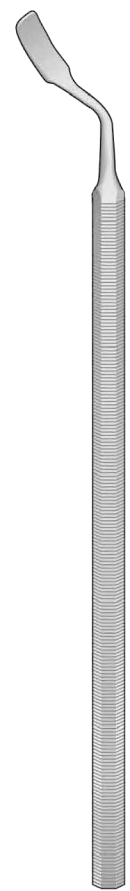
Raspatorien  
Raspatories  
Scollaperiosteo  
Legras  
Rugines



TM-DL-59  
150 mm

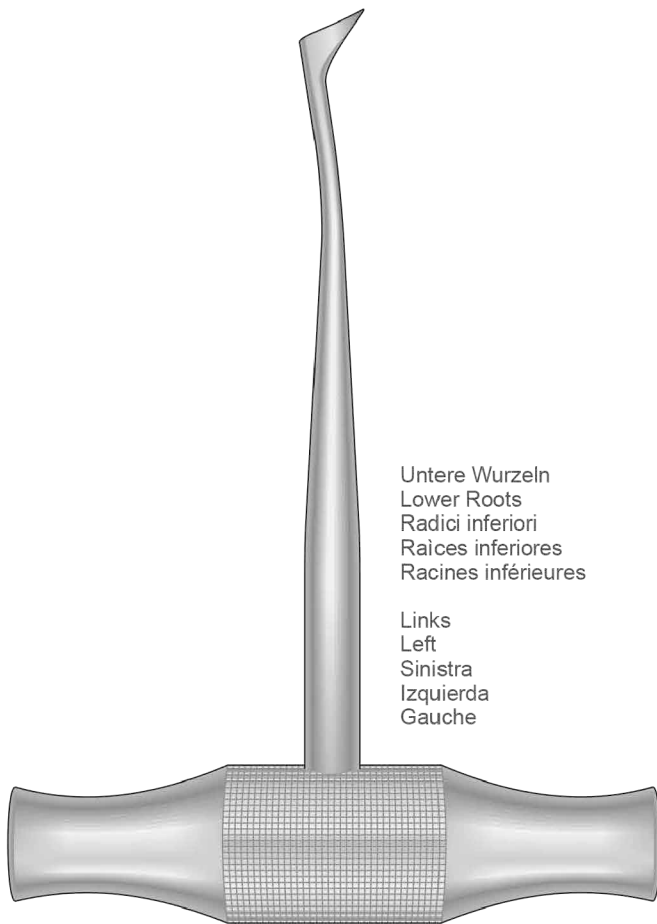


TM-DL-68  
150 mm

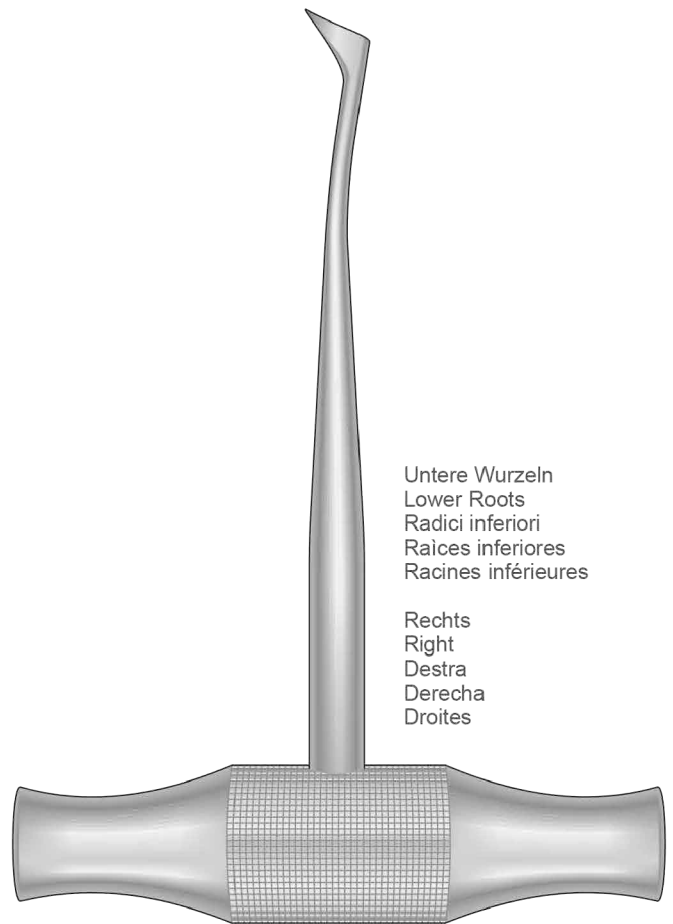


TM-DL-69  
150 mm

Wurzelheber  
Root Elevators  
Leve per radici  
Elevadores para raíces  
Elevateurs à racines



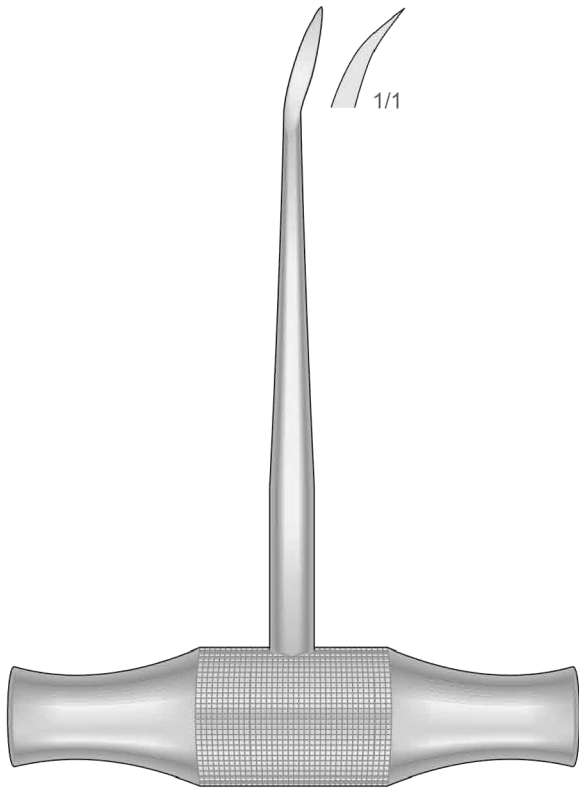
WINTER  
TM-DL-100  
Fig.1



WINTER  
TM-DL-101  
Fig.2

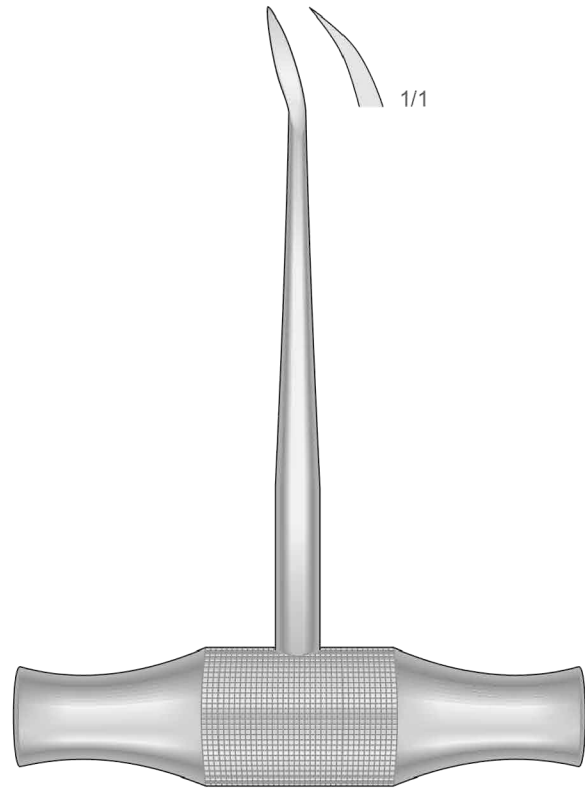


Fig. 1L



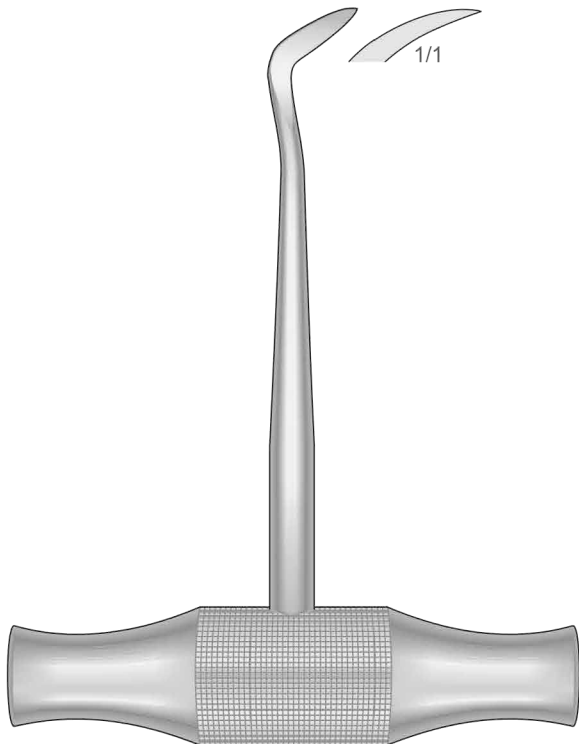
WINTER  
TM-DL-64  
120 mm

Fig. 1R



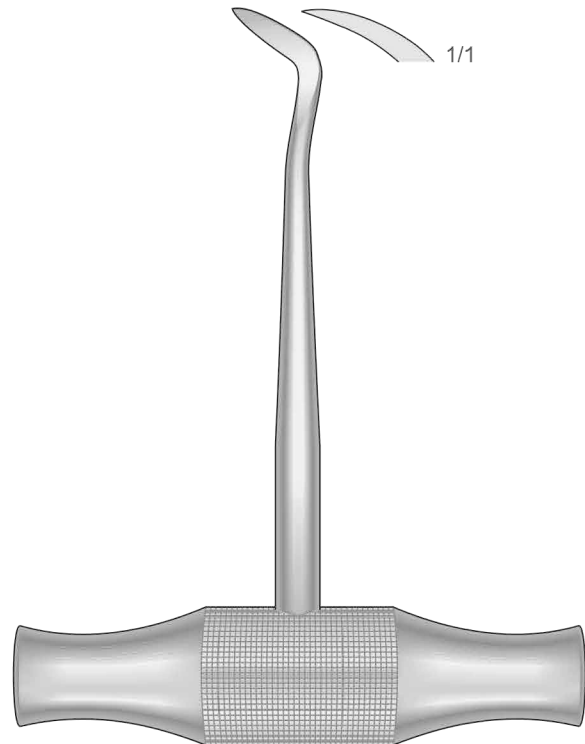
WINTER  
TM-DL-65  
120 mm

Fig. 14L



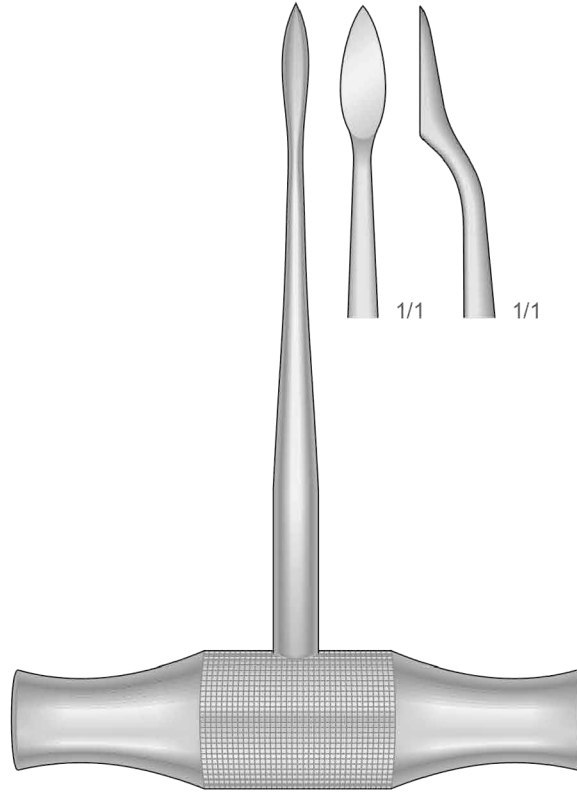
WINTER  
TM-DL-66  
125 mm

Fig. 14R

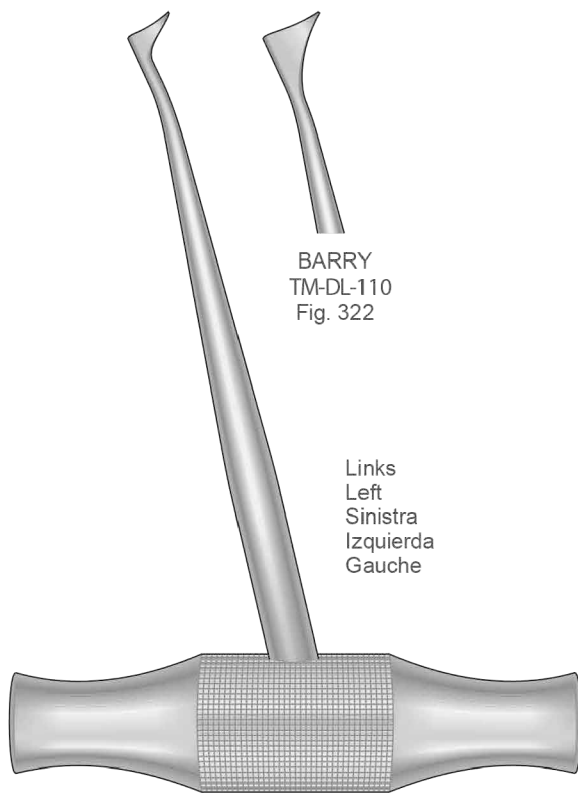


WINTER  
TM-DL-67  
125 mm

Wurzelheber  
Root Elevators  
Leve per radici  
Elevadores para raíces  
Elevateurs à racines



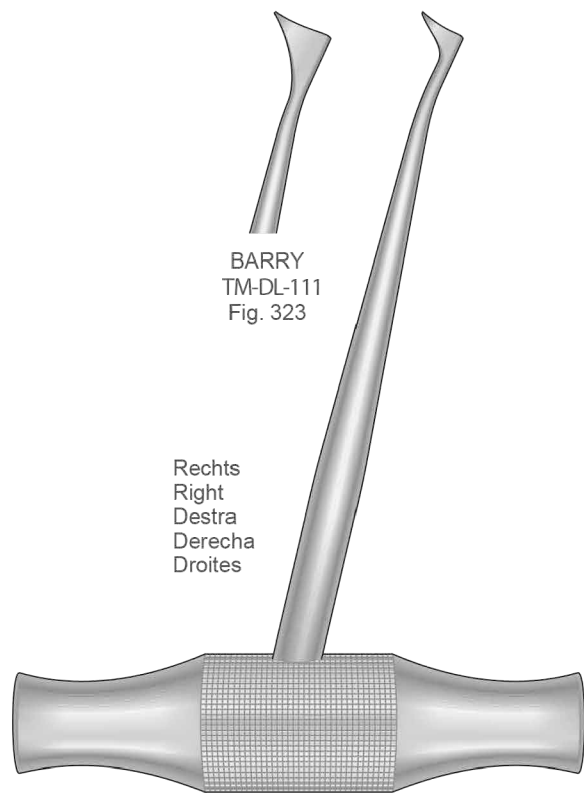
LECLUSE  
TM-DL-90  
130 mm



BARRY  
TM-DL-110  
Fig. 322

Links  
Left  
Sinistra  
Izquierda  
Gauche

BARRY  
TM-DL-108 Fig. 320  
115 mm

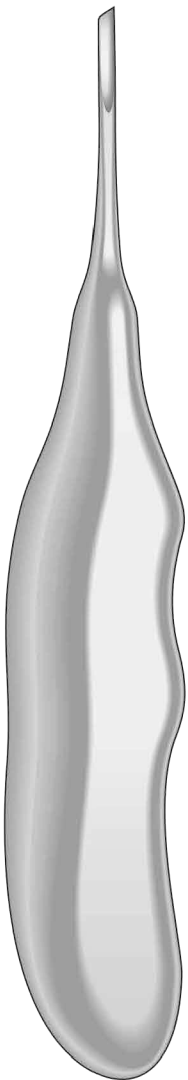


BARRY  
TM-DL-111  
Fig. 323

Rechts  
Right  
Destra  
Derecha  
Droites

BARRY  
TM-DL-109 Fig. 321  
115 mm

3 mm



TM-LA-1  
160 mm

3 mm



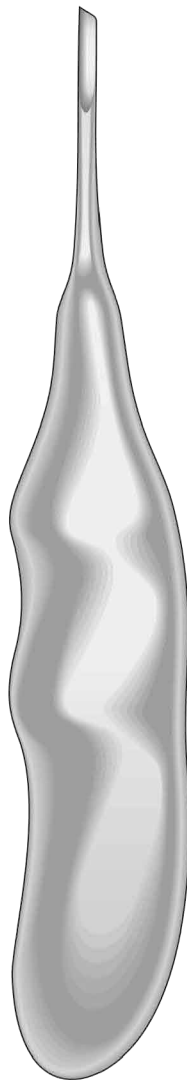
TM-LA-2  
160 mm

4 mm



TM-LA-3  
160 mm

4 mm



TM-LA-4  
160 mm

4,5 mm



TM-LA-5  
160 mm

4,5 mm



TM-LA-6  
160 mm

Wurzelheber  
Root Elevators  
Leve per radici  
Elevadores para raíces  
Elevateurs à racines



TM-LA-7  
160 mm



TM-LA-8  
160 mm



TM-LA-9  
160 mm



TM-LA-10  
160 mm

2 mm



TM-LA-11  
155 mm

3 mm



TM-LA-12  
155 mm

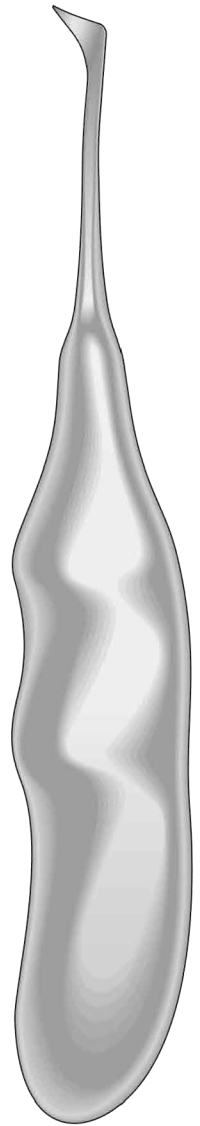
4 mm



TM-LA-13  
155 mm



TM-LA-16  
160 mm



TM-LA-17  
160 mm

Wurzelheber  
Root Elevators  
Leve per radici  
Elevadores para raíces  
Elevateurs à racines

3 mm



TM-LA-20  
160 mm

3 mm



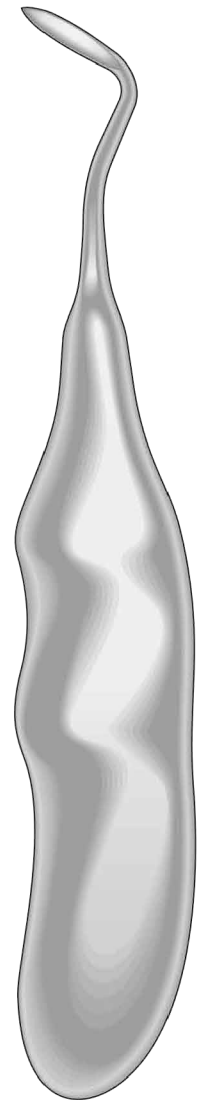
TM-LA-21  
160 mm

4 mm



TM-LA-22  
160 mm

4 mm



TM-LA-23  
160 mm

Syndesmotome  
Syndesmotomes  
Sindesmotomo  
Syndesmòtomos  
Syndesmotomes



Massiv  
Solid  
Manico  
Pieno  
Massif

CHOMPRET  
TM-CH-11  
150 mm



Massiv  
Solid  
Manico  
Pieno  
Massif

CHOMPRET  
TM-CH-12  
150 mm



Massiv  
Solid  
Manico  
Pieno  
Massif

CHOMPRET  
TM-CH-13  
150 mm



Massiv  
Solid  
Manico  
Pieno  
Massif

CHOMPRET  
TM-CH-14  
145 mm



CHOMPRET  
TM-CH-1  
165 mm



CHOMPRET  
TM-CH-2  
165 mm



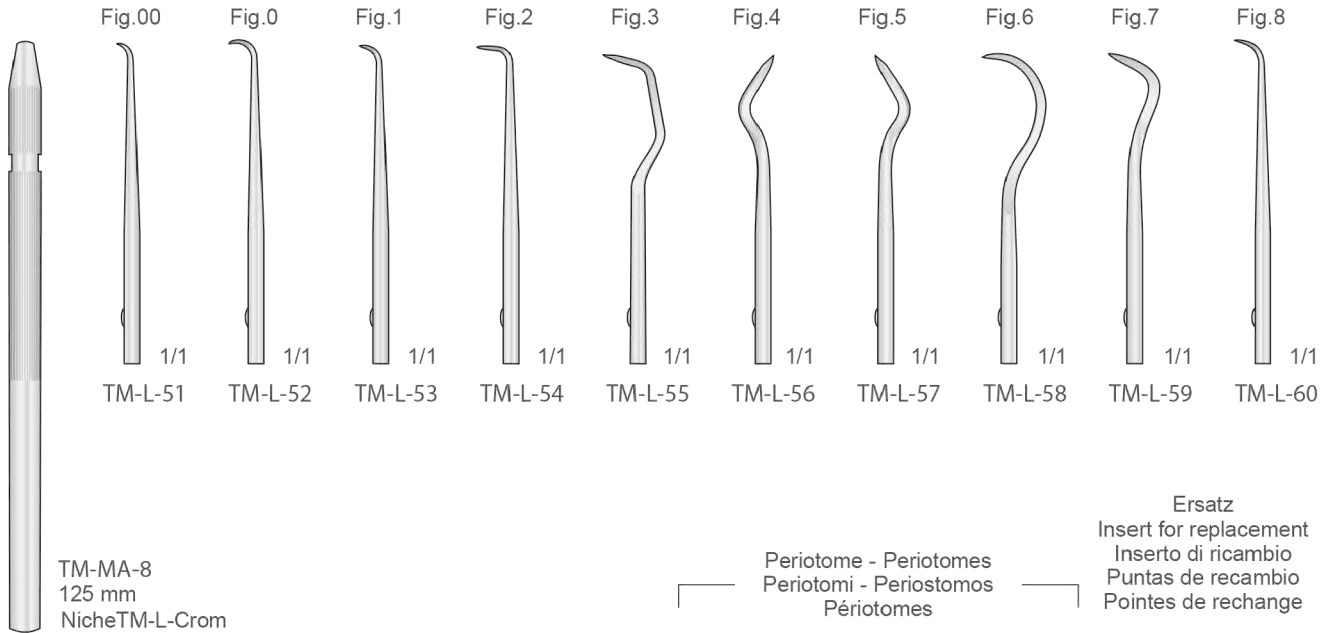
CHOMPRET  
TM-CH-3  
165 mm



CHOMPRET  
TM-CH-4  
160 mm

Zahnreiniger - Periotome  
 Scalers - Periotomes  
 Ablatori di tartaro - Periotomi  
 Limpiadores de sarro - Periotomos  
 Detartreurs - Périotomes

MORSE - SCALERS

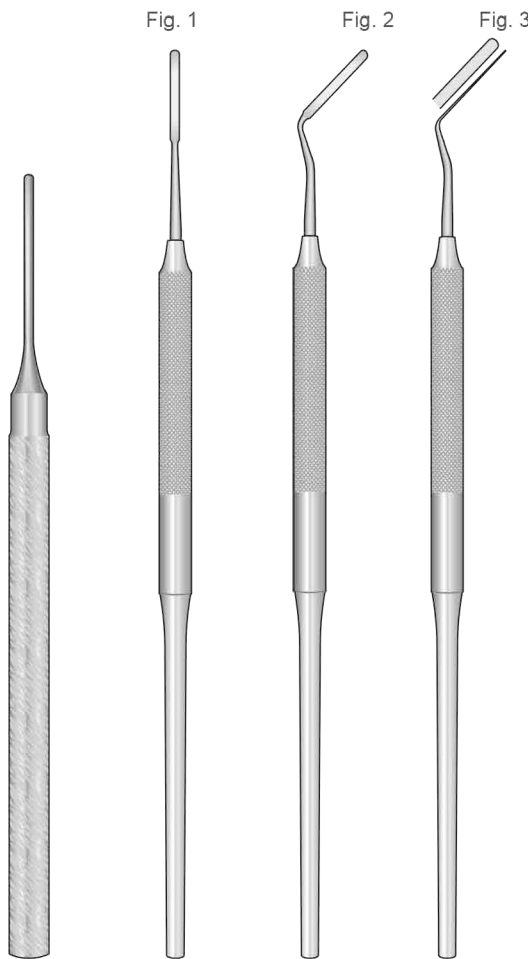


Ersatz  
 Insert for replacement  
 Inserto di ricambio  
 Puntas de recambio  
 Pointes de rechange

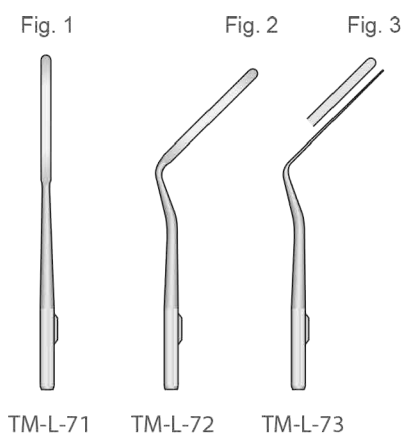
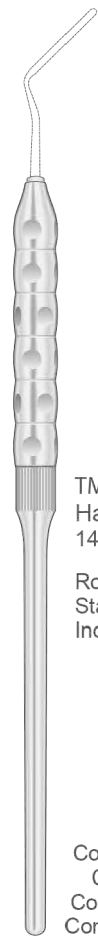
Periotome - Periotomes  
 Periotomi - Periotomos  
 Périotomes

Periotome - Periotomes  
 Periotomi - Periotomos  
 Périotomes

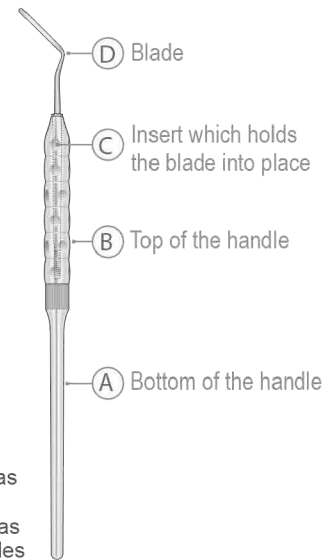
Für / For  
 Per / Para / Pour  
 TM-MA-9



TM-MIR-09 140 mm  
 TM-MC-11 160 mm  
 TM-MC-12 160 mm  
 TM-MC-13 160 mm



TM-MA-9R  
 48 mm



TM-MC-70  
 (TM-MA-9 + TM-L-71,  
 TM-L-72, TM-L-73)  
 Komplet mit 1 Griff + 3 Spatel  
 Complete with 1 Handle + 3 Spatulas  
 Completo di 1 Manico + 3 Spatole  
 Completo con 1 mango + 3 Espátulas  
 Complete avec 1 Manche + 3 Spatules

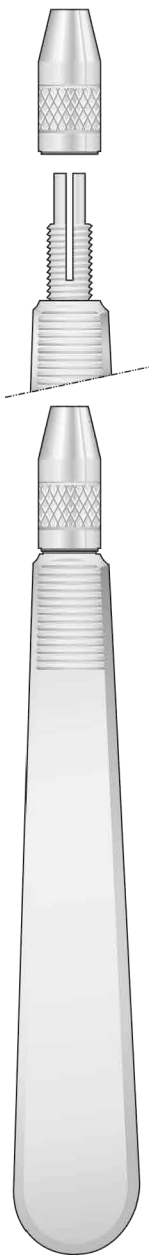


**TM-SDM-C**  
Komplett mit 2 Griffe + 20 Klingen  
Complete with 2 Handles + 20 Blades  
Completo di 2 Manici + 20 lame  
Completo con 2 mangos + 20 hojas  
Complete avec 2 Manches + 20 lames

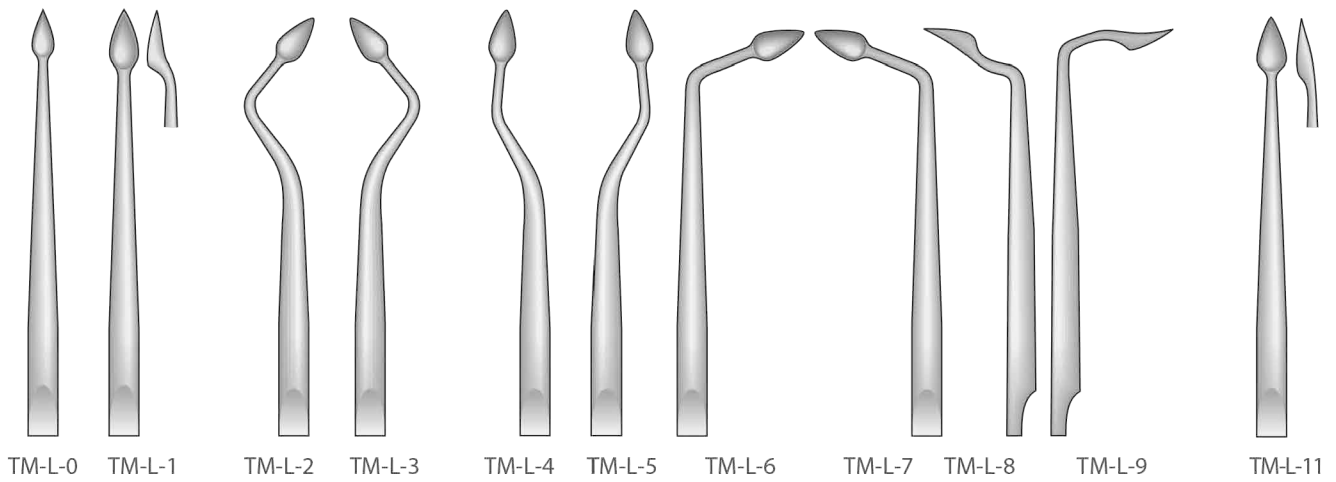
**TM-SD-M**  
Griff  
Handle  
Manico  
Mango  
Manche

**TM-SDM-9**  
Komplett mit 2 Griffe + 9 Klingen APICALI  
Complete with 2 Handles + 9 Blades APICALI  
Completo di 2 Manici + 9 lame APICALI  
Completo con 2 mangos + 9 hojas APICALI  
Complete avec 2 Manches + 9 lames APICALI

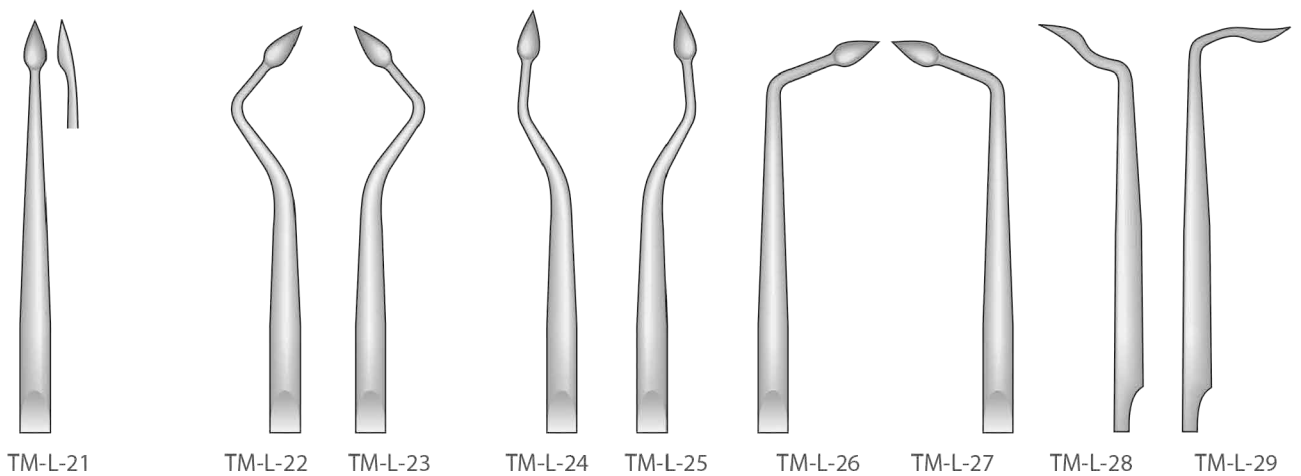
**TM-SDM-11**  
Komplett mit 2 Griffe + 11 Klingen CERVICALI  
Complete with 2 Handles + 11 Blades CERVICALI  
Completo di 2 Manici + 11 lame CERVICALI  
Completo con 2 mangos + 11 hojas CERVICALI  
Complete avec 2 Manches + 11 lames CERVICALI



Lame CERVICALI

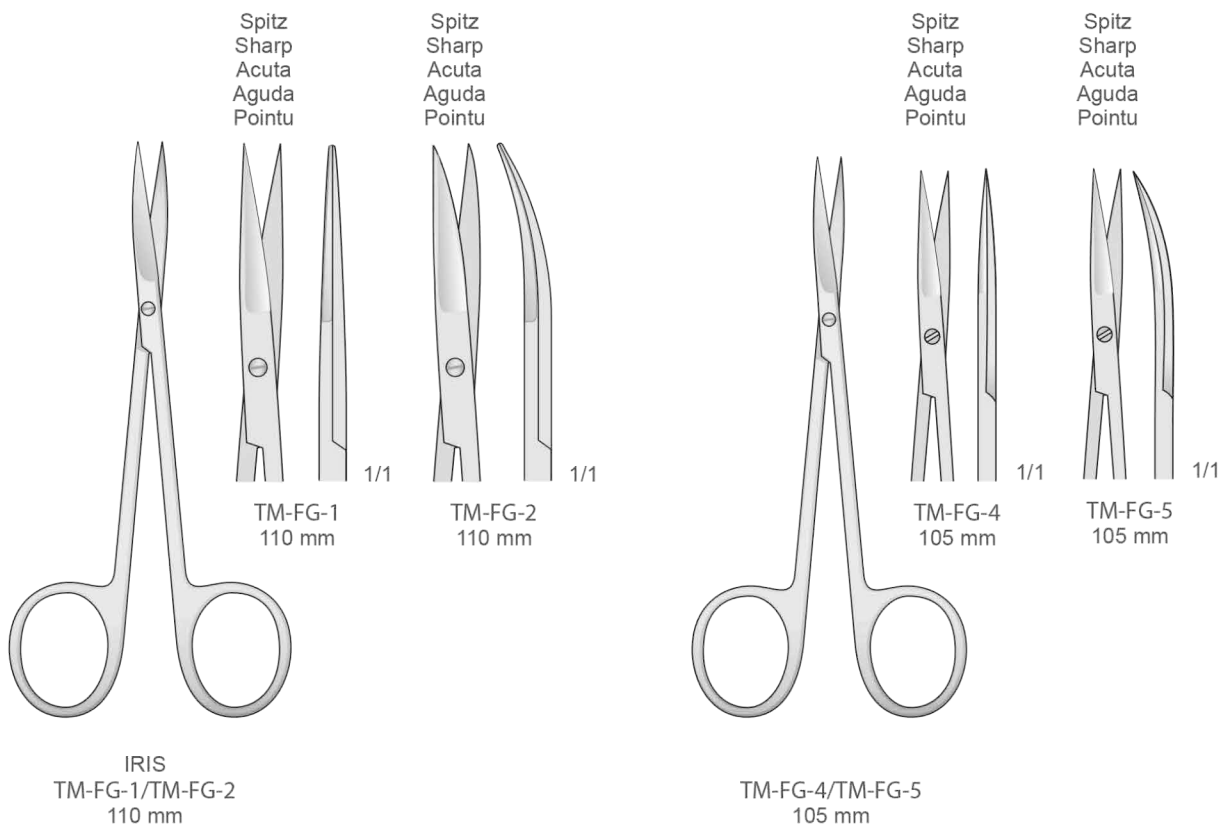
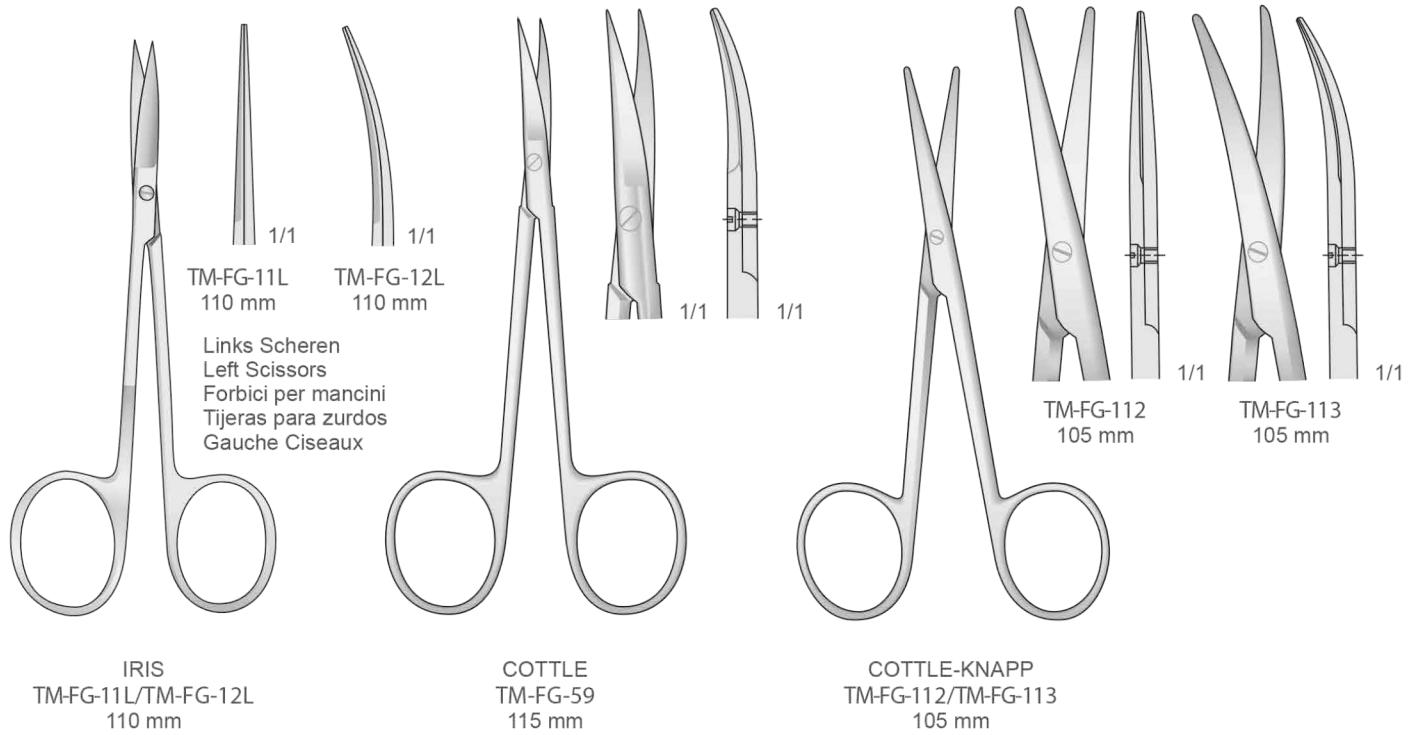


Lame APICALI



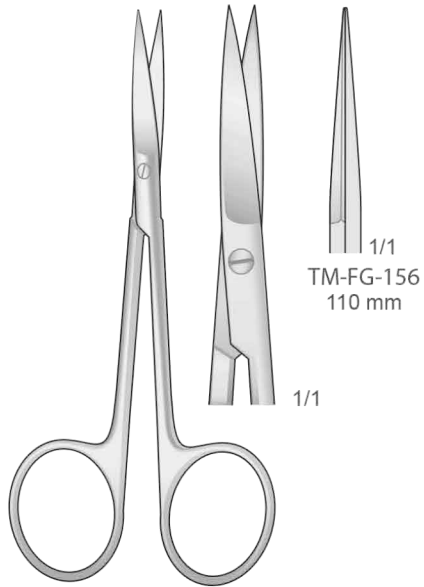
TM-SD-M

L = links  
left  
mancini  
izquierdo  
gauche



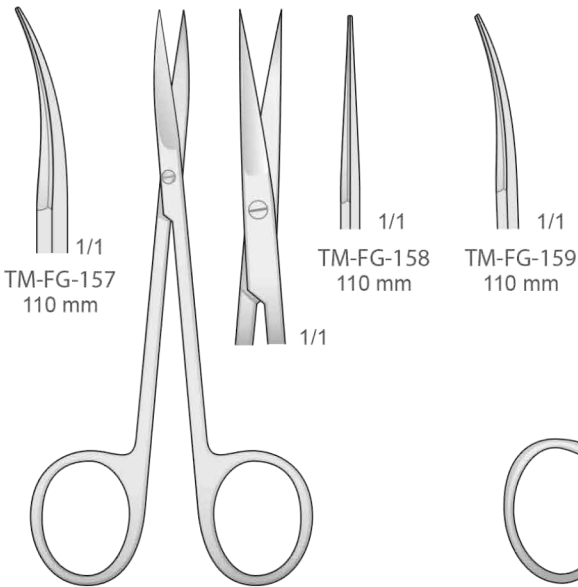
Scheren  
Scissors  
Forbici  
Tijeras  
Ciseaux

Gezahnt - Serrated  
Dentellata - Dentelé - Dentadas

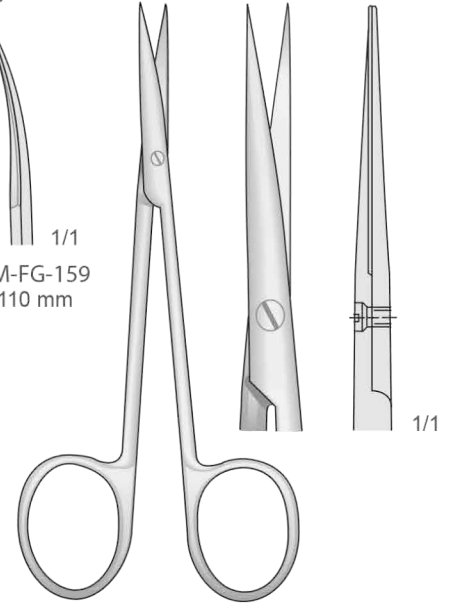


TM-FG-156/TM-FG-157  
110 mm

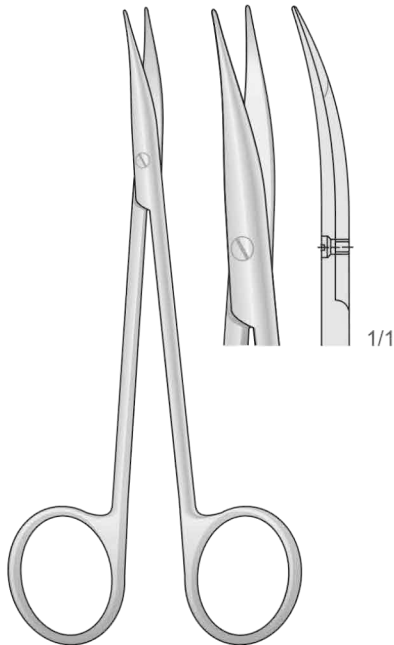
Gezahnt - Serrated  
Dentellata - Dentelé - Dentadas



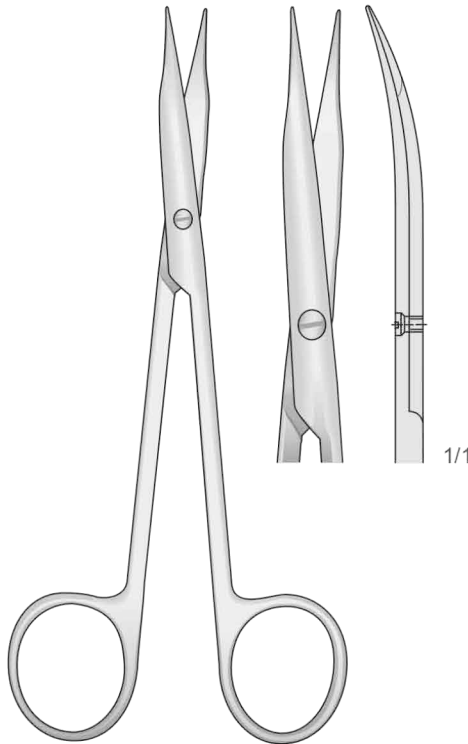
TM-FG-158/TM-FG-159  
110 mm



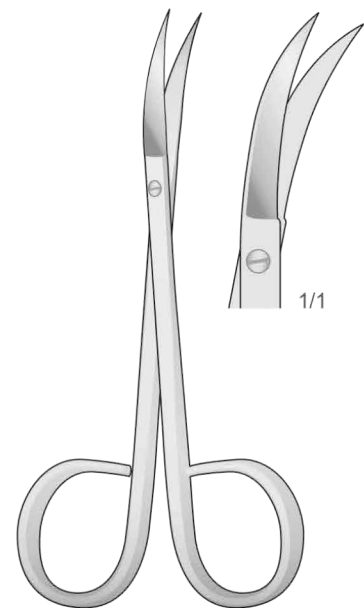
KILNER  
TM-FG-58  
115 mm



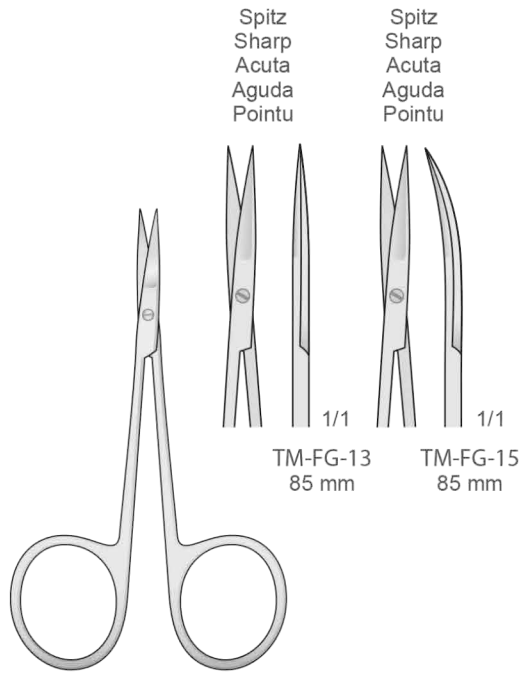
JAMESON-WERBER  
TM-FG-123  
130 mm



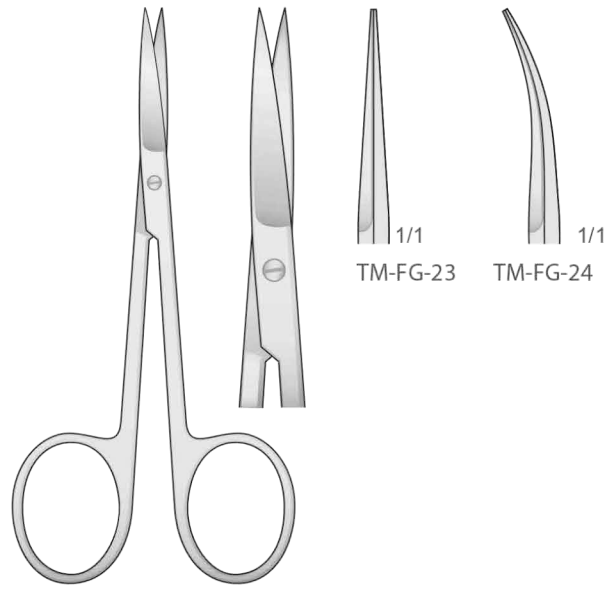
JAMESON  
TM-FG-124  
145 mm



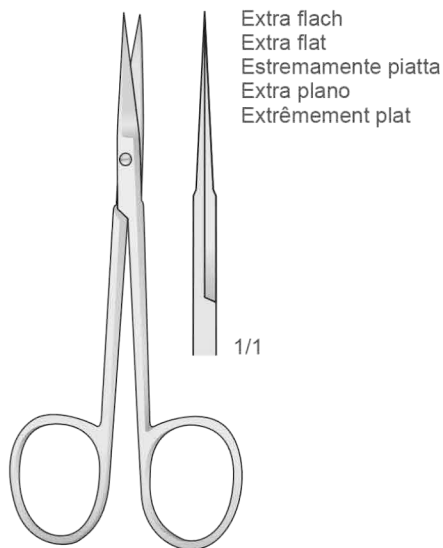
TM-FG-3  
115 mm



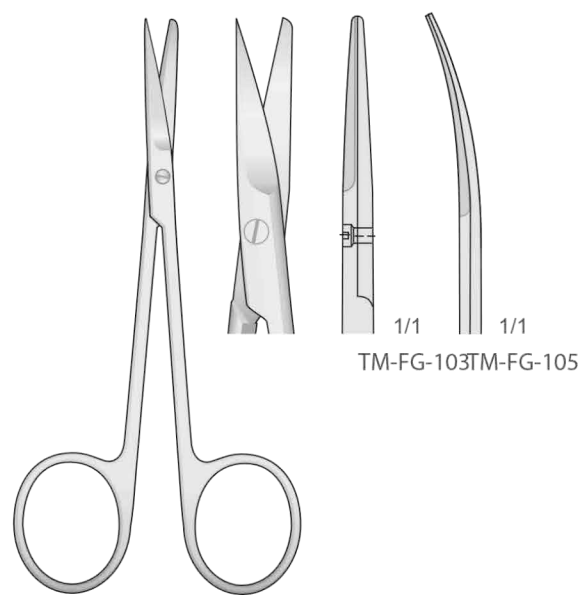
MICRO-IRIS  
TM-FG-13/TM-FG-15  
85 mm



TM-FG-23/TM-FG-24  
110 mm



TM-FG-104  
100 mm

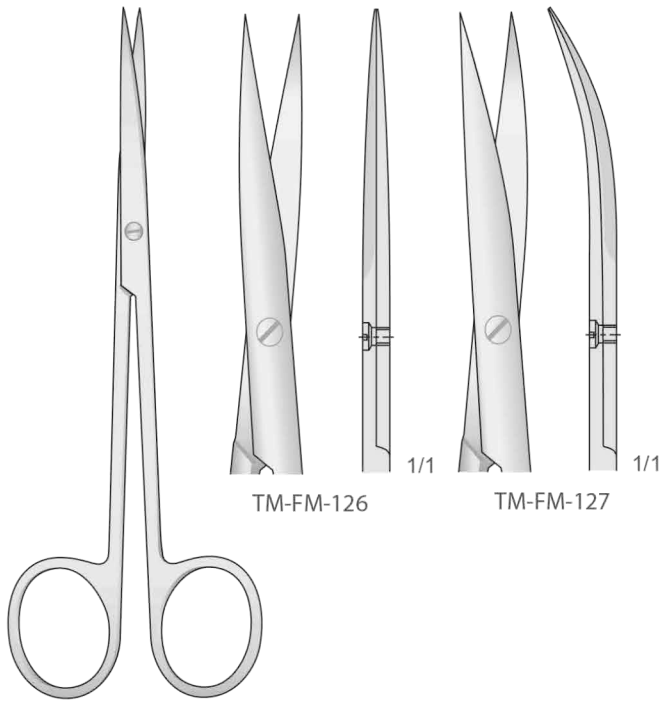


TM-FG-103/TM-FG-105  
110 mm

Scheren  
Scissors  
Forbici  
Tijeras  
Ciseaux

Spitz - Sharp  
Acuta - Agudo  
Aigu

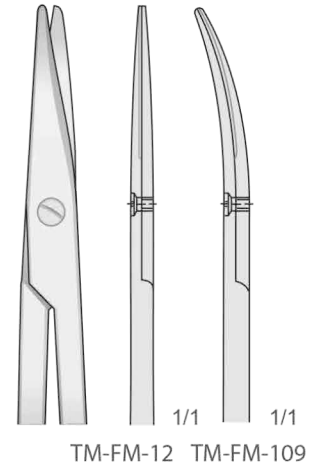
Spitz - Sharp  
Acuta - Agudo  
Aigu



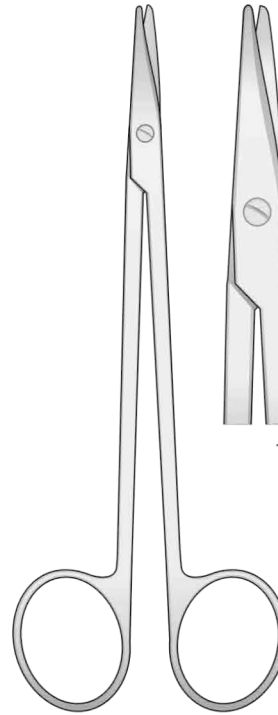
TM-FM-126

TM-FM-127

METZENBAUM  
TM-FM-126/TM-FM-127  
145 mm



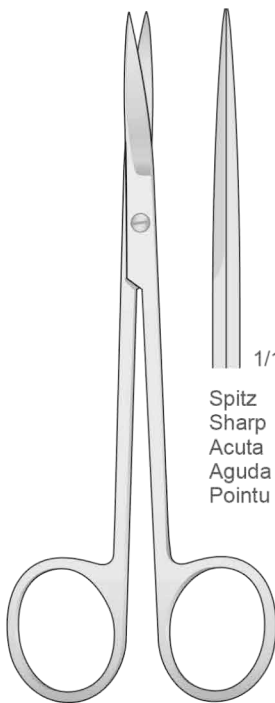
TM-FM-12 TM-FM-109



METZENBAUM  
TM-FM-12/TM-FM-109  
150 mm

1/1

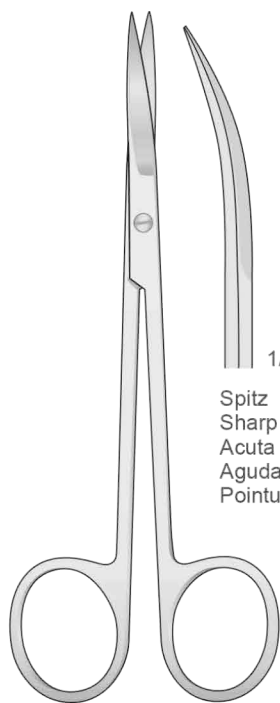
Spitz  
Sharp  
Acuta  
Aguda  
Pointu



METZENBAUM  
TM-FG-28  
145 mm

1/1

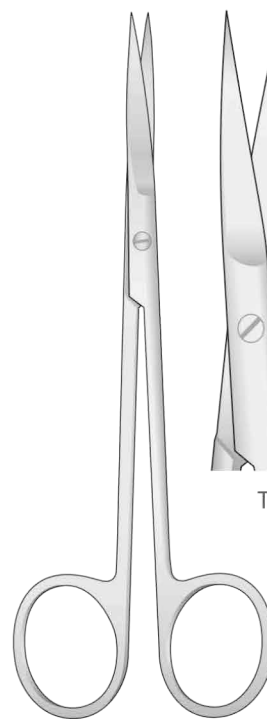
Spitz  
Sharp  
Acuta  
Aguda  
Pointu



METZENBAUM  
TM-FG-14  
145 mm

1/1

TM-FG-147  
150 mm

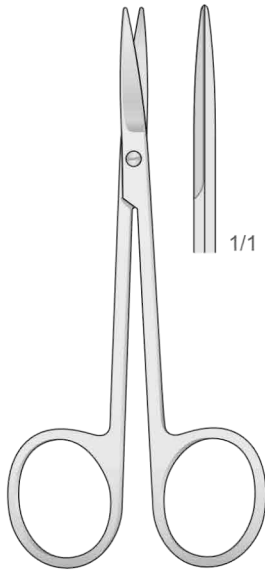


JOSEPH  
TM-FG-147/TM-FG-148  
150 mm

1/1

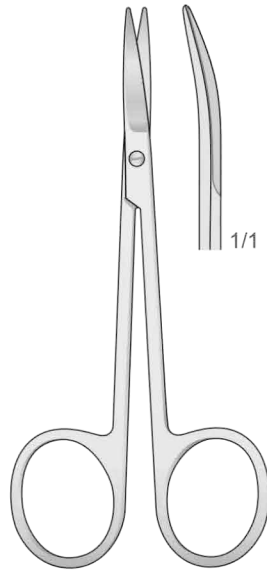
TM-FG-148  
150 mm

Stumpf  
Blunt  
Smussa  
Romas  
Mousse



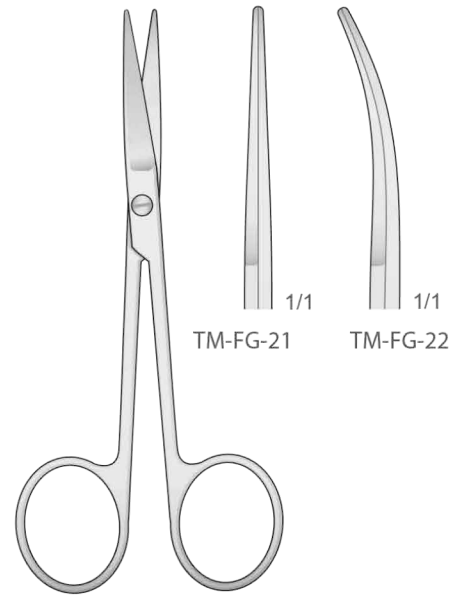
TM-FG-101  
110 mm

Stumpf  
Blunt  
Smussa  
Romas  
Mousse



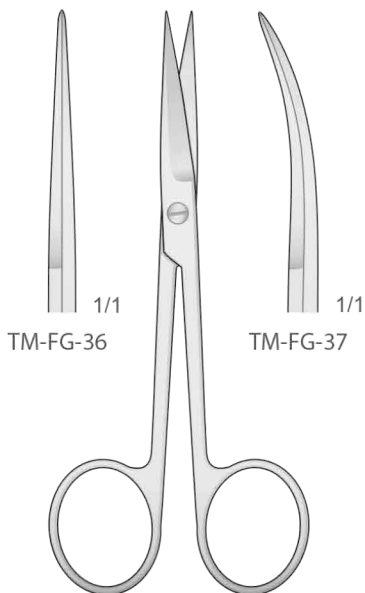
TM-FG-102  
110 mm

Stumpf  
Blunt  
Smussa  
Romas  
Mousse

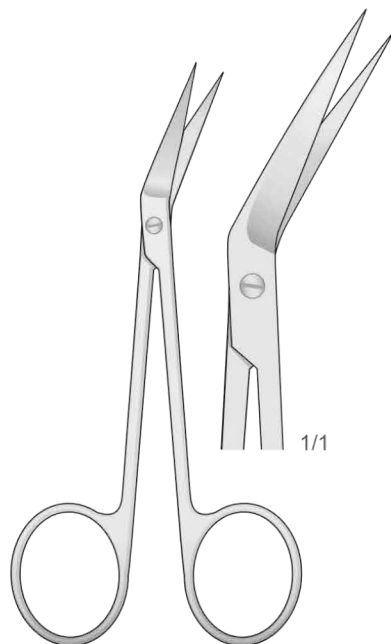


TM-FG-21/TM-FG-22  
115 mm

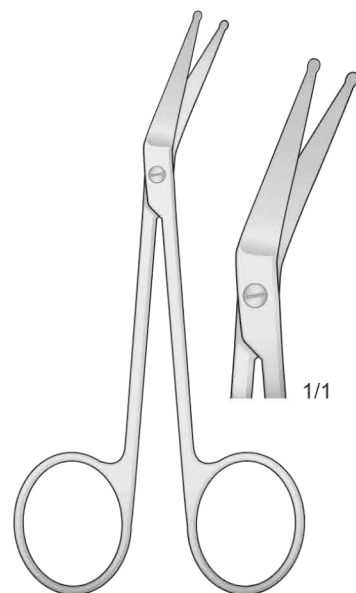
Spitz  
Sharp  
Acute  
Agudas  
Pointu



TM-FG-36/TM-FG-37  
115 mm

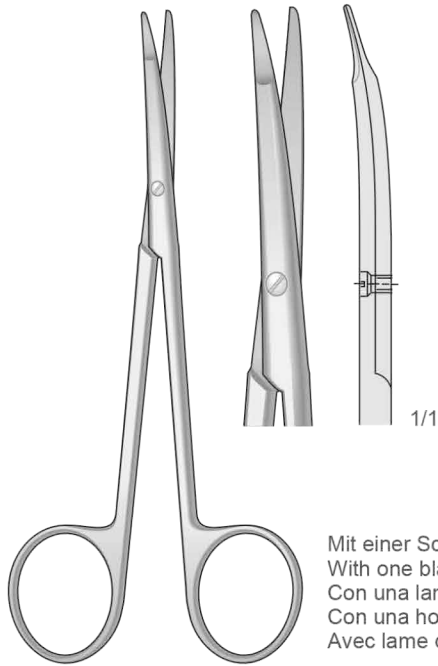


LOCKLIN  
TM-LK-1  
115 mm



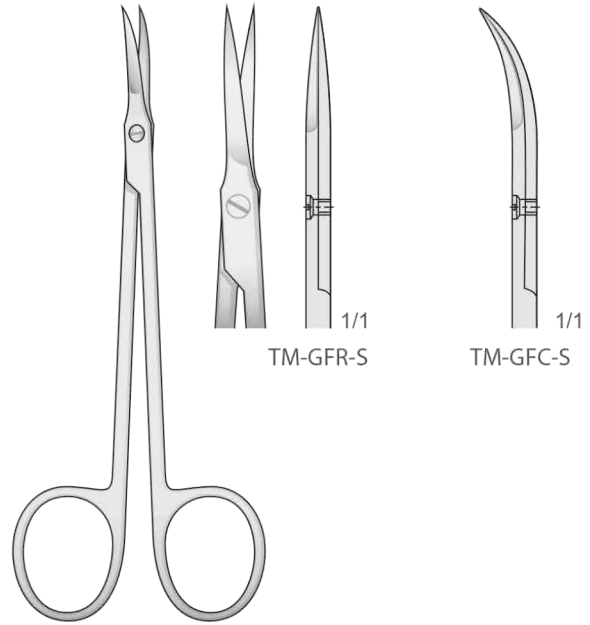
LOCKLIN MOD.  
TM-LK-3  
110 mm

Scheren  
Scissors  
Forbici  
Tijeras  
Ciseaux



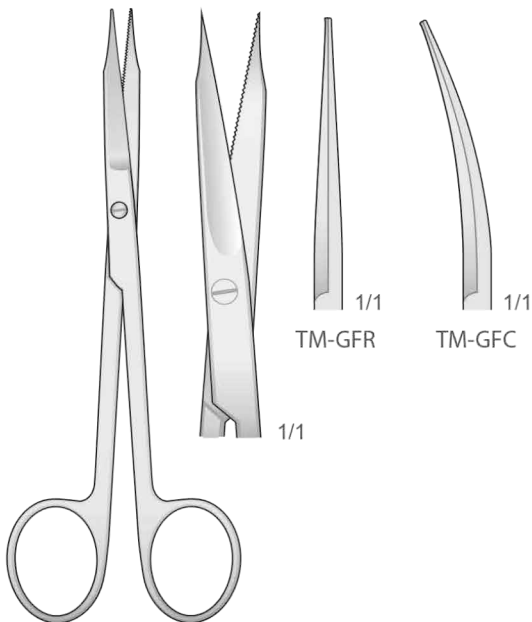
Mit einer Schneide gezahnt  
With one blade serrated  
Con una lama zigrinata  
Con una hoja dentada  
Avec lame dentelé

KILNER  
TM-FG-121  
130 mm



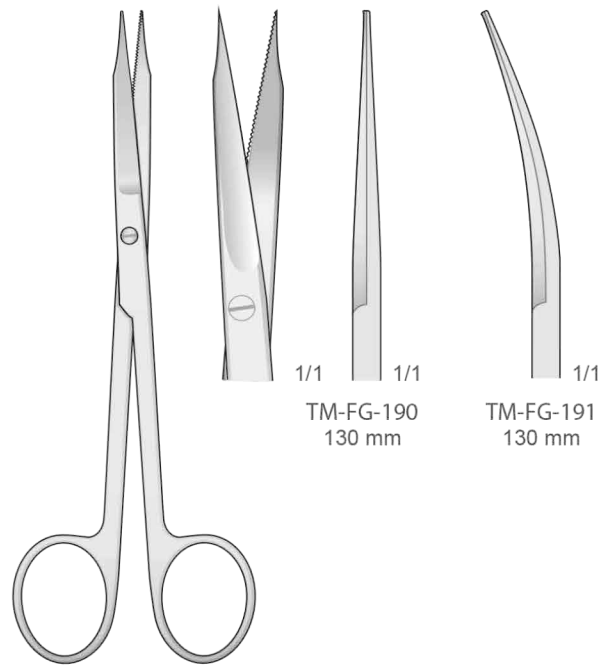
TM-GFR-S/TM-GFC-S  
120 mm

Gezahnt - Serrated  
Dentellata - Dentadas  
Dentelé



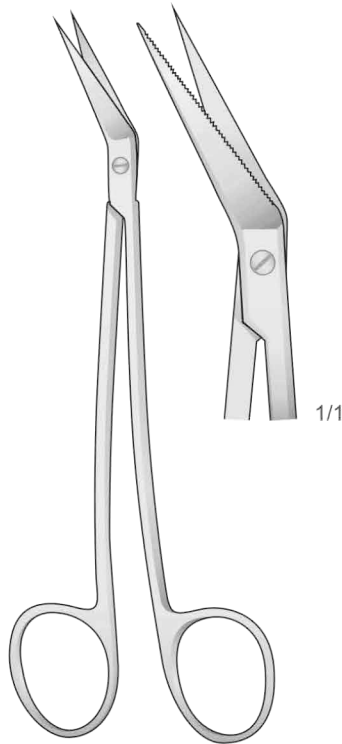
GOLDMAN-FOX  
GFR/GFC  
120 mm

Gezahnt - Serrated  
Dentellata - Dentadas  
Dentelé

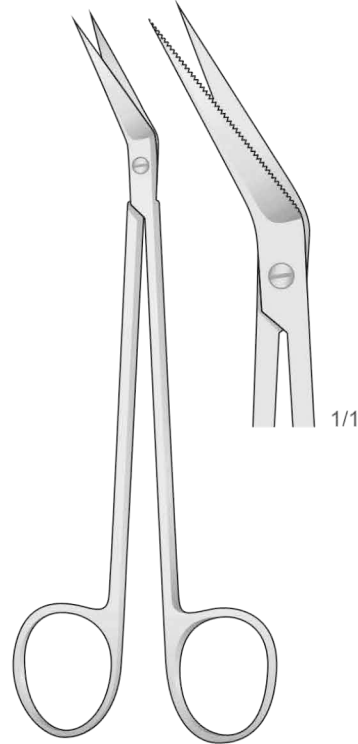


GOLDMAN-FOX  
TM-FG-190/TM-FG-191  
130 mm

Gezahnt - Serrated  
Dentellata - Dentadas  
Dentelé

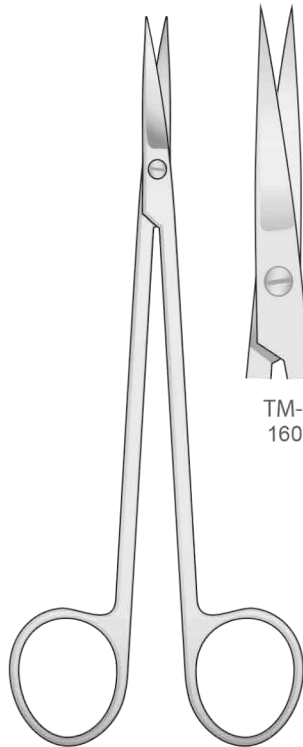


LOCKLIN  
TM-LK-2  
160 mm

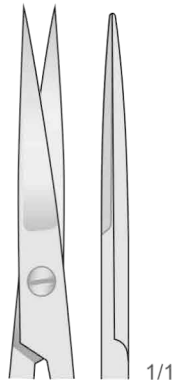


LOCKLIN  
TM-LK-4  
160 mm

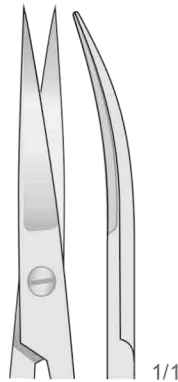
Gezahnt - Serrated  
Dentellata - Dentadas  
Dentelé



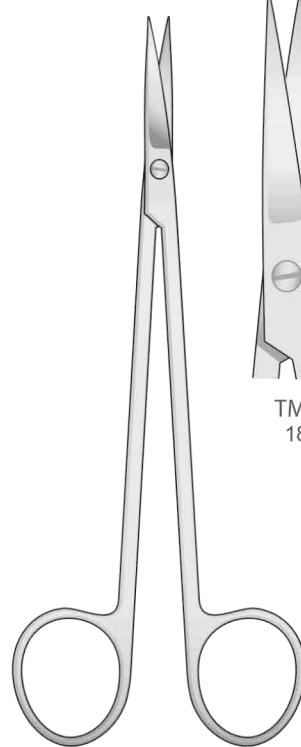
KELLY  
TM-FK-1 / TM-FK-2  
160 mm



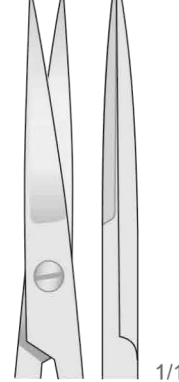
TM-FK-1  
160 mm



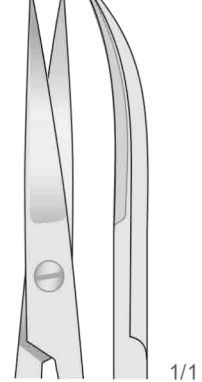
TM-FK-2  
160 mm



KELLY  
TM-FK-87 / TM-FK-88  
180 mm



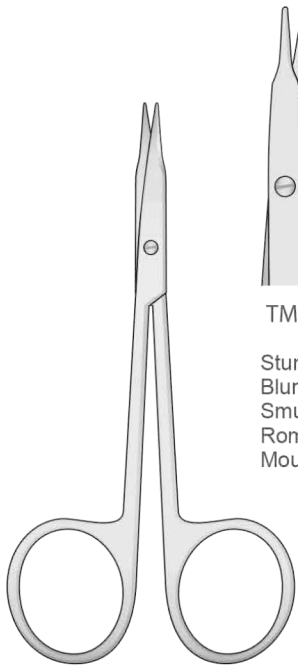
TM-FK-87  
180 mm



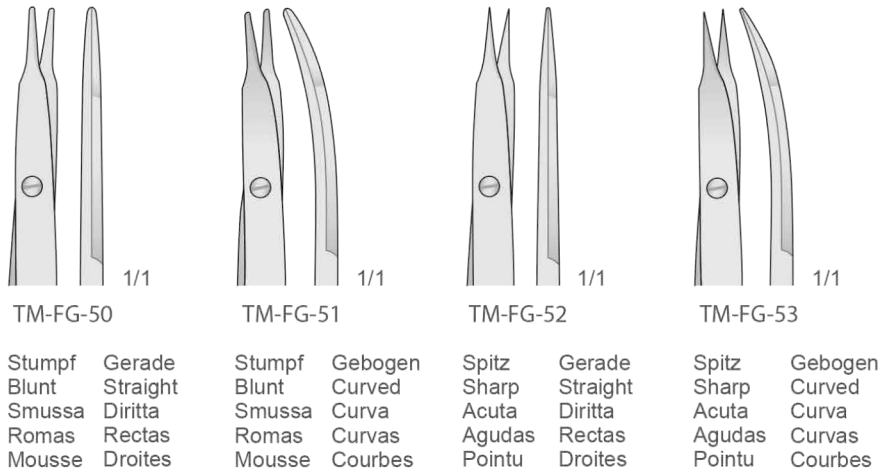
TM-FK-88  
180 mm



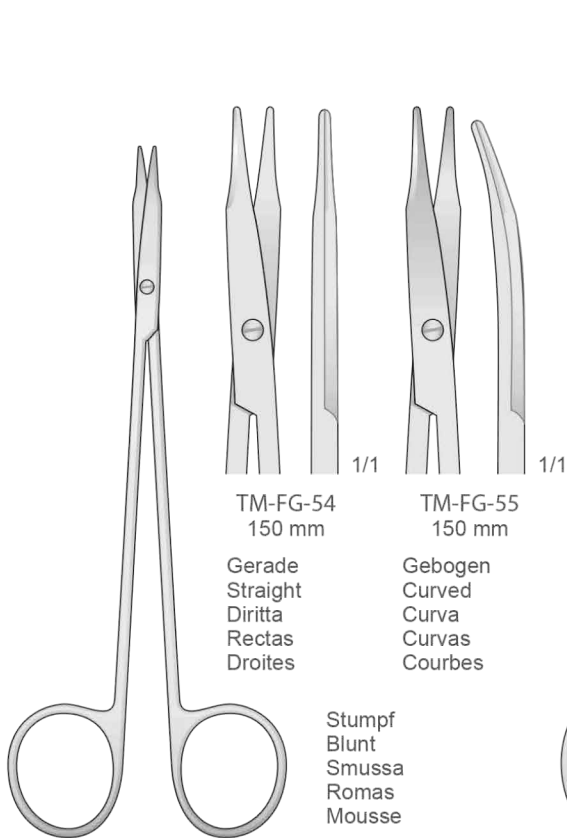
Scheren  
Scissors  
Forbici  
Tijeras  
Ciseaux



STEVENS  
TM-FG-50/TM-FG-53  
110 mm



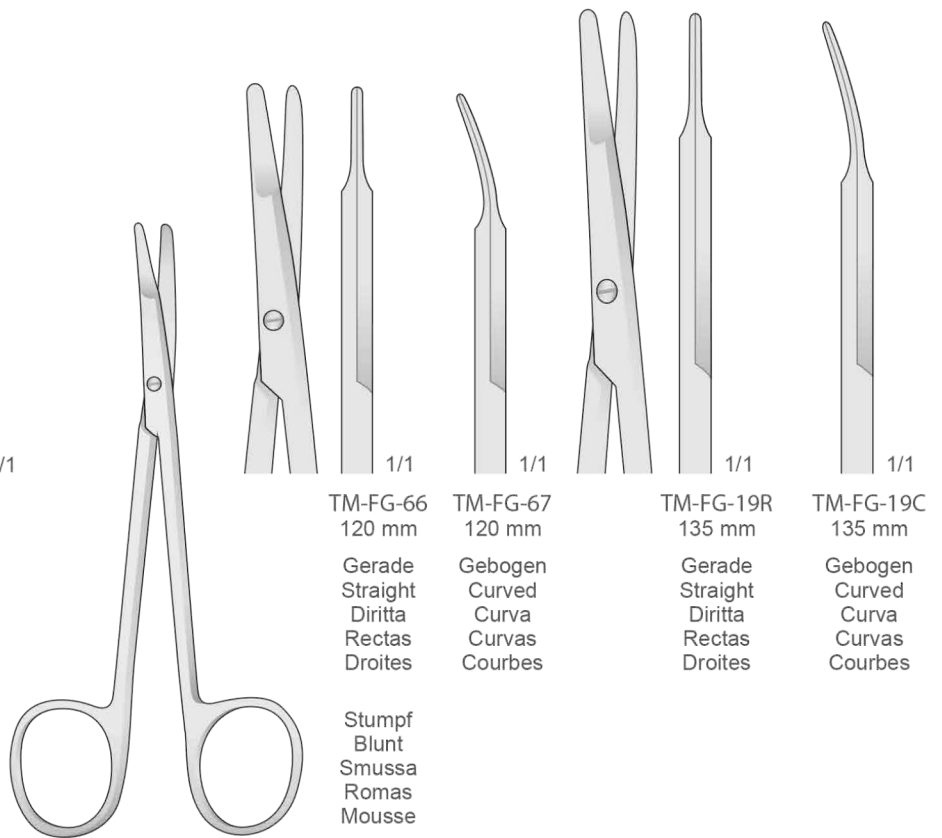
|  |  |  |   |
|--|--|--|---|
| TM-FG-50                                     | TM-FG-51   | TM-FG-52   | TM-FG-53  |
| Stumpf<br>Blunt<br>Smussa<br>Romas<br>Mousse | Gerade<br>Straight<br>Diritta<br>Rectas<br>Droites | Gebogen<br>Curved<br>Curva<br>Curvas<br>Courbes    | Spitz<br>Sharp<br>Acuta<br>Agudas<br>Pointu     |
|  |  | Gerade<br>Straight<br>Diritta<br>Rectas<br>Droites | Gebogen<br>Curved<br>Curva<br>Curvas<br>Courbes |



REYNOLDS  
TM-FG-54/TM-FG-55

|  |   |
|--|---|
| TM-FG-54<br>150 mm                                 | TM-FG-55<br>150 mm                              |
| Gerade<br>Straight<br>Diritta<br>Rectas<br>Droites | Gebogen<br>Curved<br>Curva<br>Curvas<br>Courbes |

Stumpf  
Blunt  
Smussa  
Romas  
Mousse



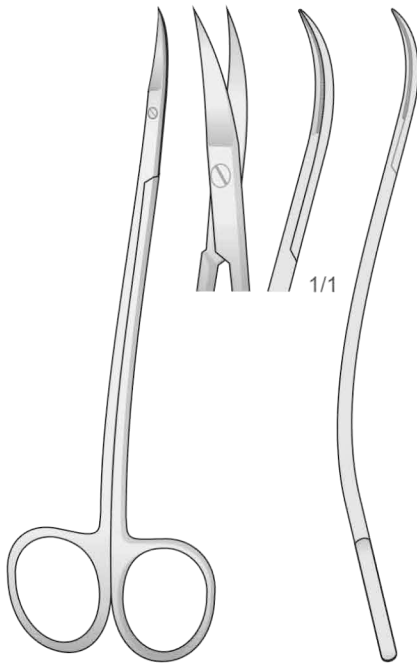
KILNER  
TM-FG-19C/TM-FG-67

|  |   |  |   |
|--|---|--|---|
| TM-FG-66<br>120 mm                                 | TM-FG-67<br>120 mm                              | TM-FG-19R<br>135 mm                                | TM-FG-19C<br>135 mm                             |
| Gerade<br>Straight<br>Diritta<br>Rectas<br>Droites | Gebogen<br>Curved<br>Curva<br>Curvas<br>Courbes | Gerade<br>Straight<br>Diritta<br>Rectas<br>Droites | Gebogen<br>Curved<br>Curva<br>Curvas<br>Courbes |

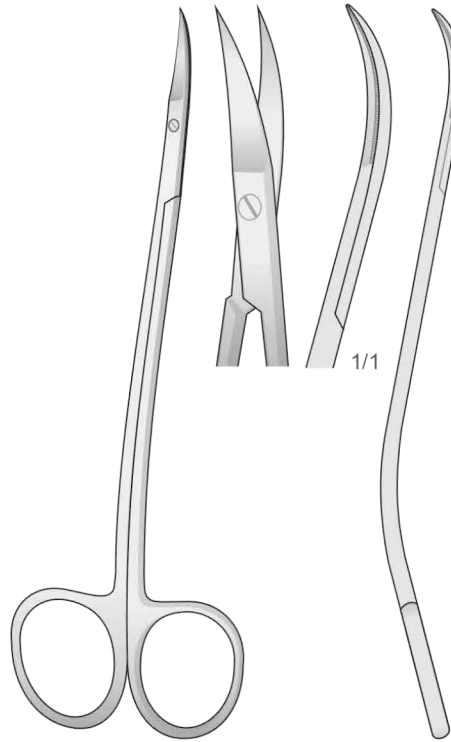
Stumpf  
Blunt  
Smussa  
Romas  
Mousse

Gezahnt - Serrated  
Dentellata - Dentadas  
Dentelé

Scheren  
Scissors  
Forbici  
Tijeras  
Ciseaux

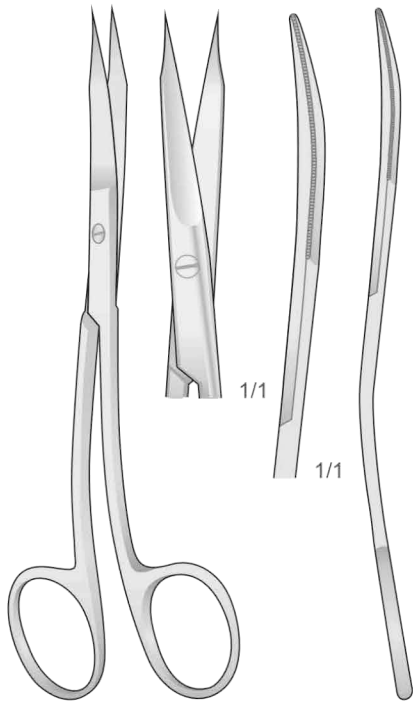


LA GRANGE  
TM-LG-1  
115 mm

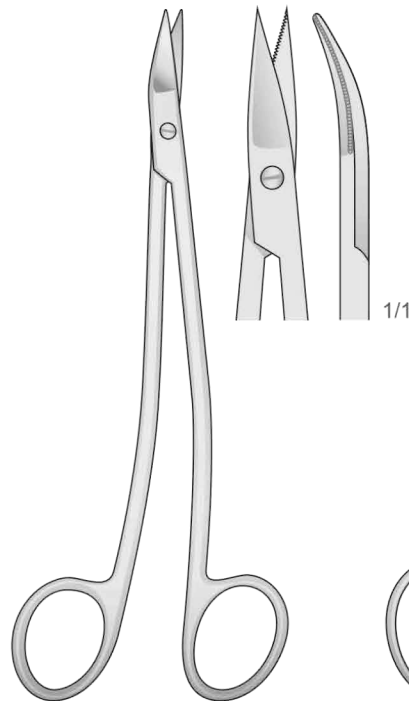


LA GRANGE  
TM-LG-6  
155 mm

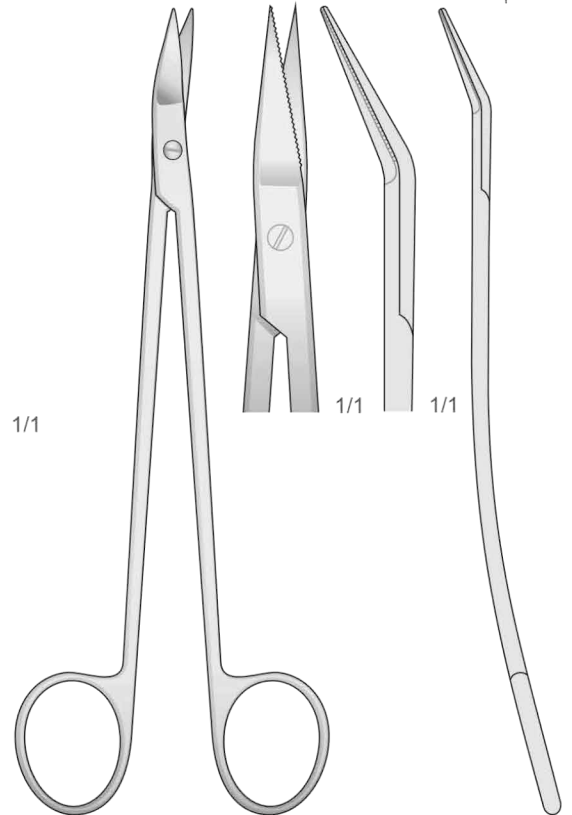
Gezahnt - Serrated  
Dentellata - Dentada  
Dentée



GOLDMAN-FOX S FORM  
GFS  
130 mm

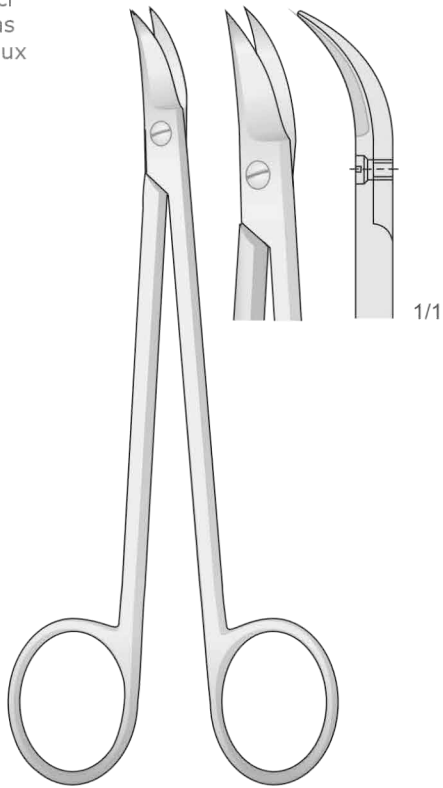


NEUMANN  
TM-FG-20  
130 mm

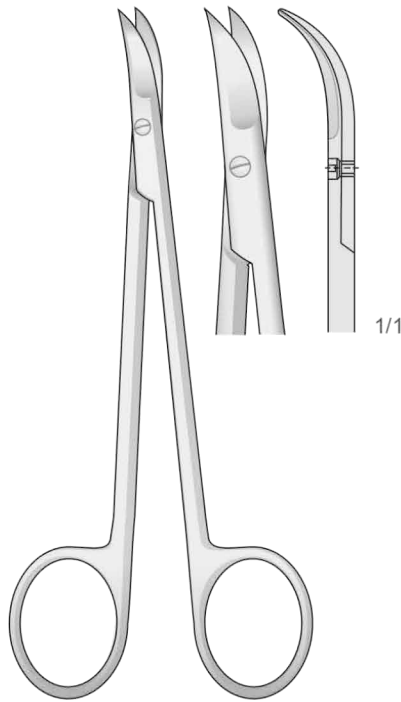


DEAN  
DEAN  
180 mm

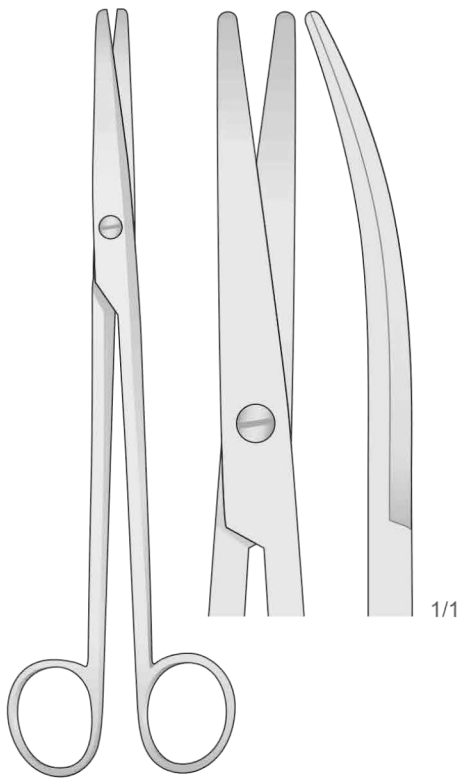
Scheren  
Scissors  
Forbici  
Tijeras  
Ciseaux



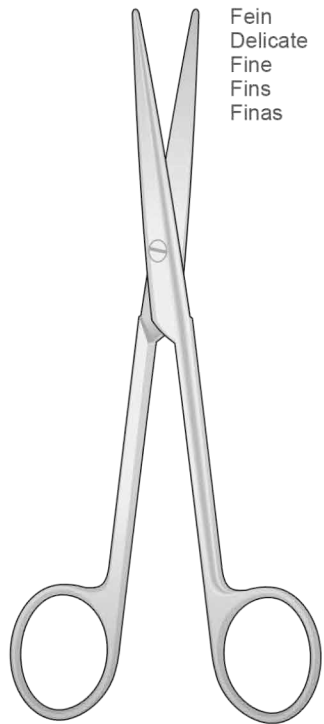
QUINBY  
TM-FG-38  
130 mm



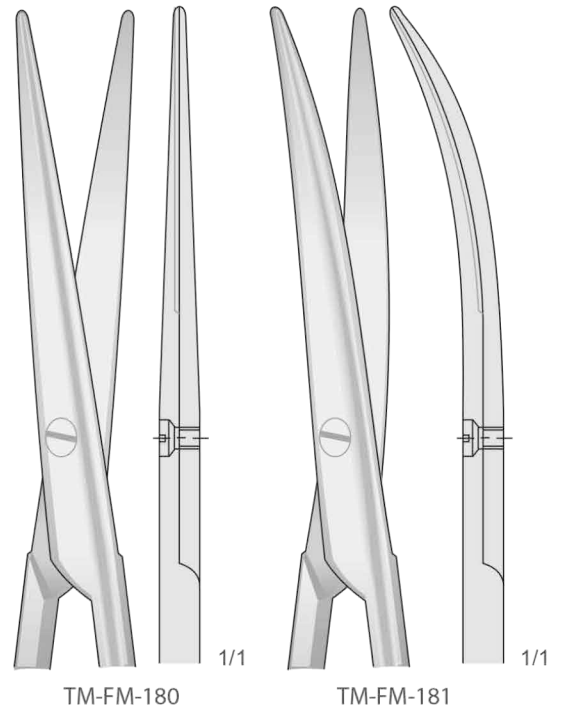
CHADWICK  
TM-FG-39  
115 mm



MAYO-LEXER  
TM-FM-79  
165 mm



LEXER  
TM-FM-180/TM-FM-181  
165 mm

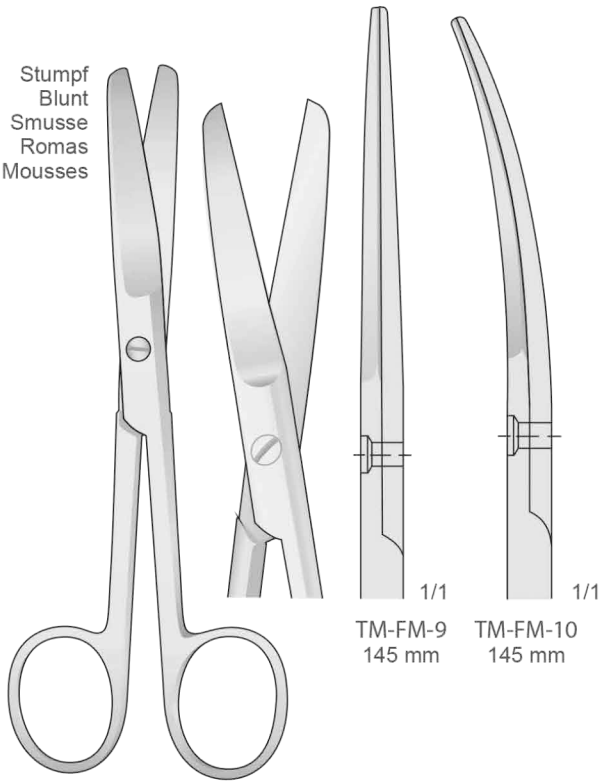


TM-FM-180

TM-FM-181

Fein  
Delicate  
Fine  
Fins  
Finas

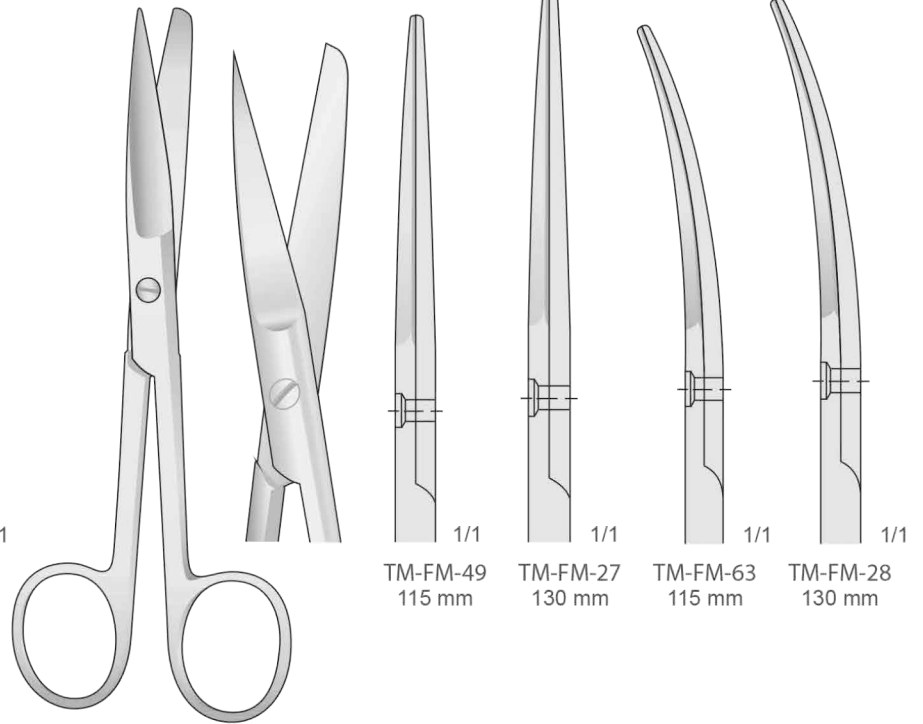
Stumpf  
Blunt  
Smusse  
Romas  
Mousses



TM-FM-9  
145 mm

TM-FM-10  
145 mm

TM-FM-9/TM-FM-10  
145 mm



TM-FM-49  
115 mm

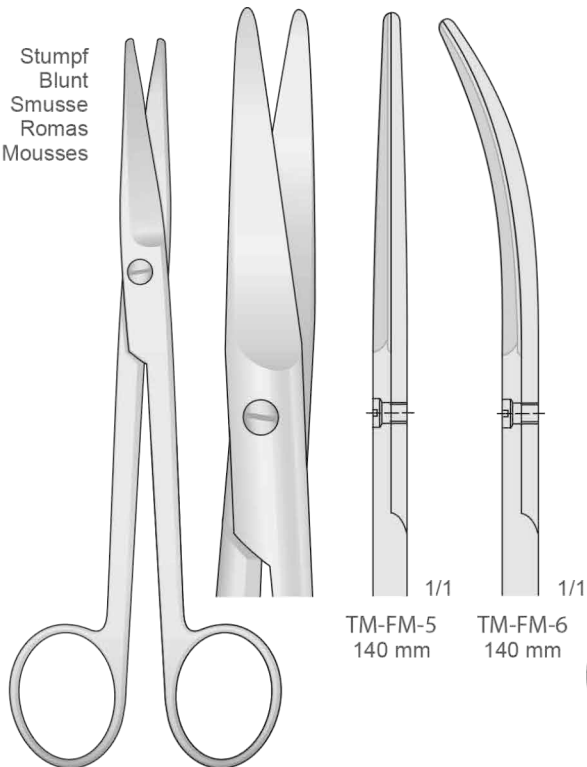
TM-FM-27  
130 mm

TM-FM-63  
115 mm

TM-FM-28  
130 mm

TM-FM-27/TM-FM-63

Stumpf  
Blunt  
Smusse  
Romas  
Mousses

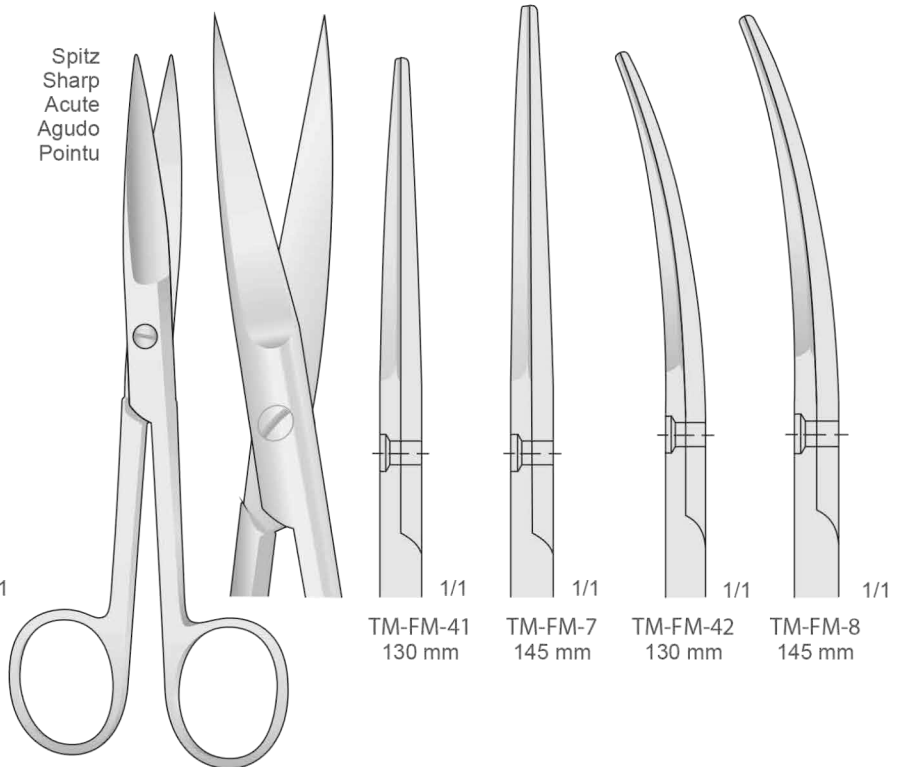


TM-FM-5  
140 mm

TM-FM-6  
140 mm

MAYO  
TM-FM-5/TM-FM-6  
140 mm

Spitz  
Sharp  
Acute  
Agudo  
Pointu



TM-FM-41  
130 mm

TM-FM-7  
145 mm

TM-FM-42  
130 mm

TM-FM-8  
145 mm

TM-FM-7/TM-FM-42

Scheren  
Scissors  
Forbici  
Tijeras  
Ciseaux

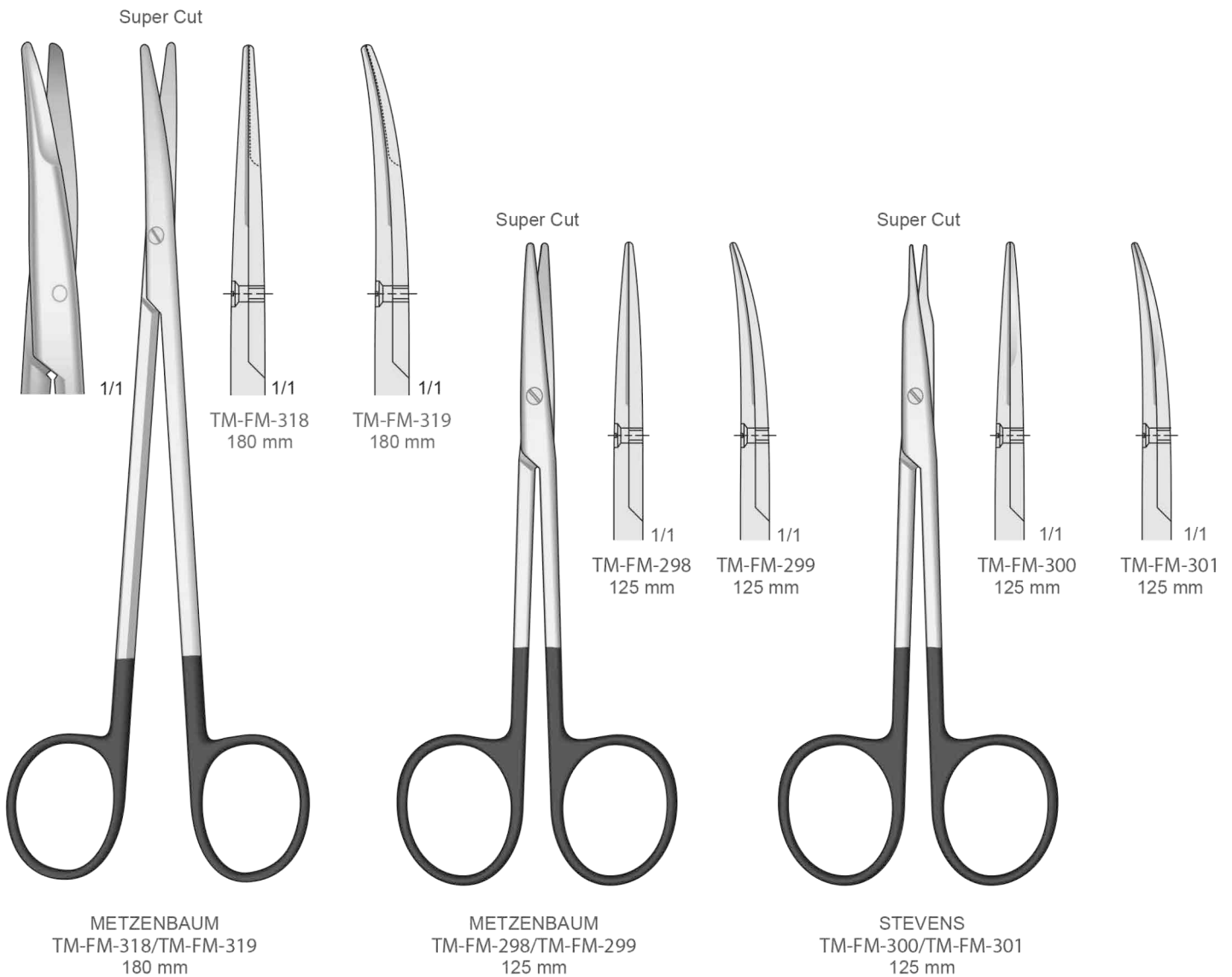
**SUPER CUT**

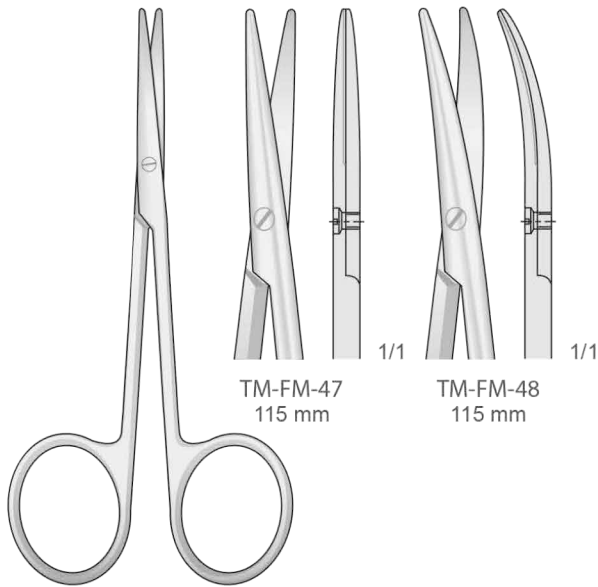


Super Cut Scissors have specially designed cutting edges.  
One regular edge and one sharp-knife edge.

**Extremely Sharp Razor Edge / Atraumatic**  
Extrem Scharfe Spitzer Beck / Atraumatische  
Tranchant extrêmement aiguisée / Atraumatique  
Borde extremadamente afilado / Atraumática  
Taglio estremamente affilato / Atraumatica

**One side serrated**  
Eine seite gezahnt  
Un côté dentelé  
Un lado dentado  
Un lato dentellato

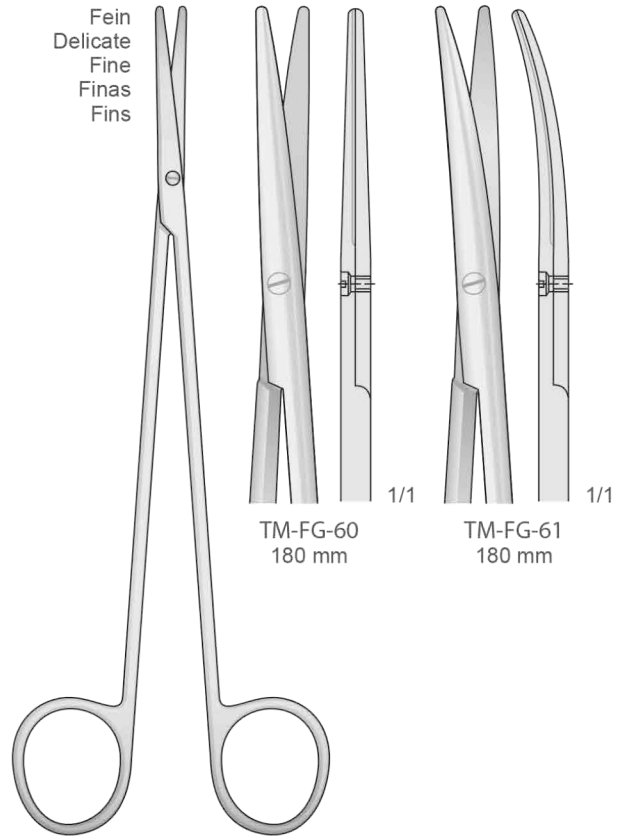




TM-FM-47  
115 mm

TM-FM-48  
115 mm

BABY - METZENBAUM  
TM-FM-47/TM-FM-48  
115 mm



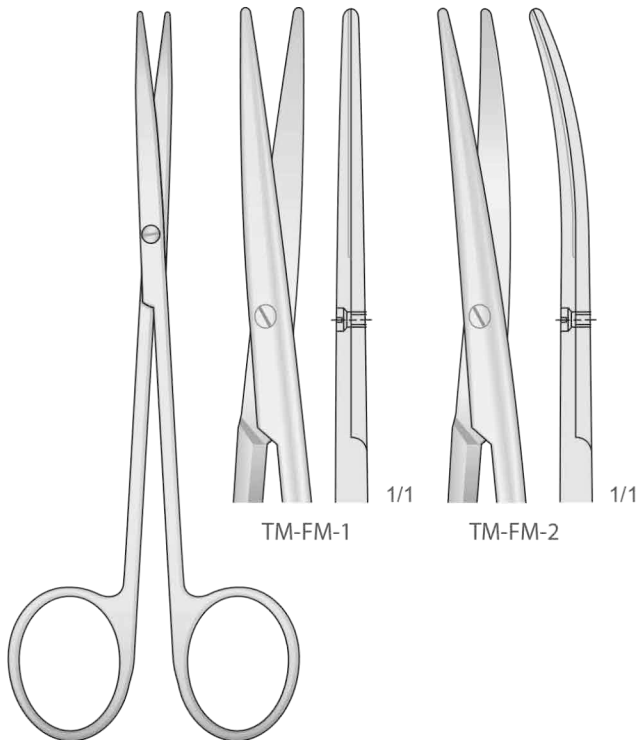
Fein  
Delicate  
Fine  
Finas  
Fins

TM-FG-60  
180 mm

TM-FG-61  
180 mm

TOENNIS-ADSON  
TM-FG-60/TM-FG-61  
180 mm

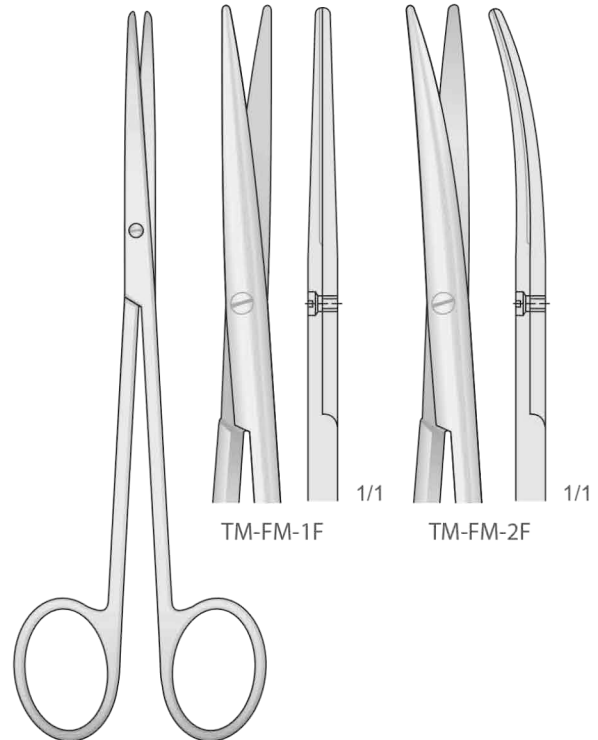
Präparierscheren - Dissecting Scissors  
Forbici per dissezione - Tijeras de disección - Ciseaux à dissection



TM-FM-1

TM-FM-2

METZENBAUM  
TM-FM-1/TM-FM-2  
145 mm

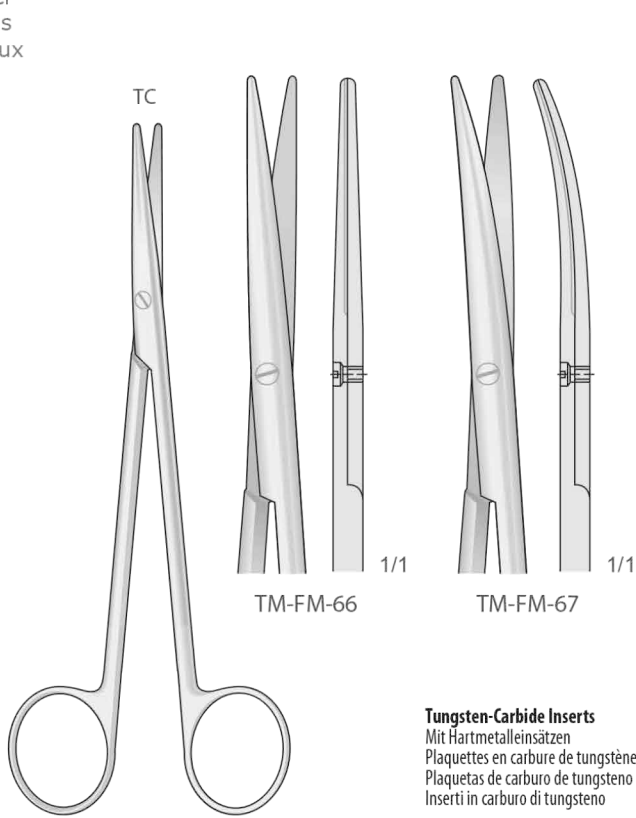


TM-FM-1F

TM-FM-2F

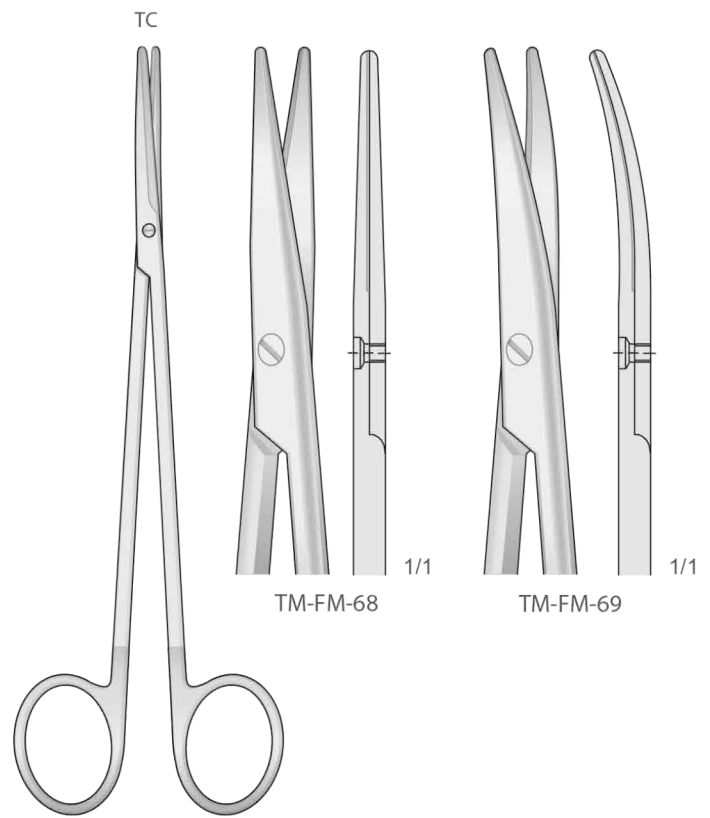
METZENBAUM-FINO  
TM-FM-1F/TM-FM-2F  
145 mm

Scheren  
Scissors  
Forbici  
Tijeras  
Ciseaux

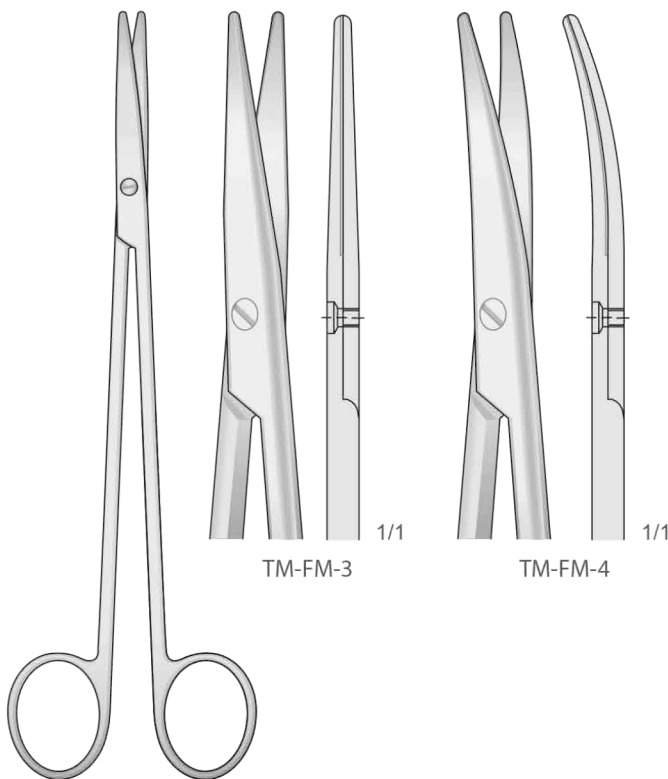


METZENBAUM  
TM-FM-66/TM-FM-67  
145 mm

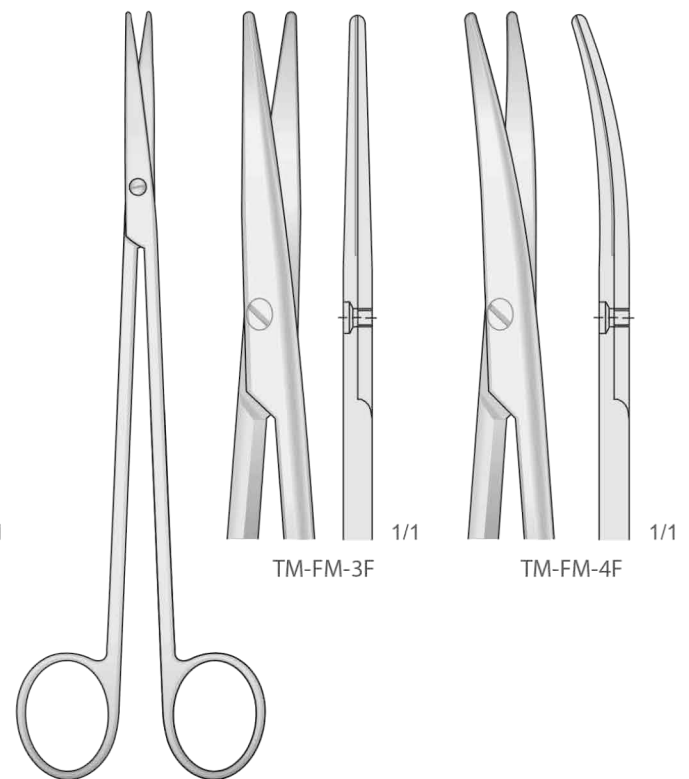
**Tungsten-Carbide Inserts**  
Mit Hartmetalleinsätzen  
Plaquettes en carbure de tungstène  
Plaquetas de carburo de tungsteno  
Inserti in carburo di tungsteno



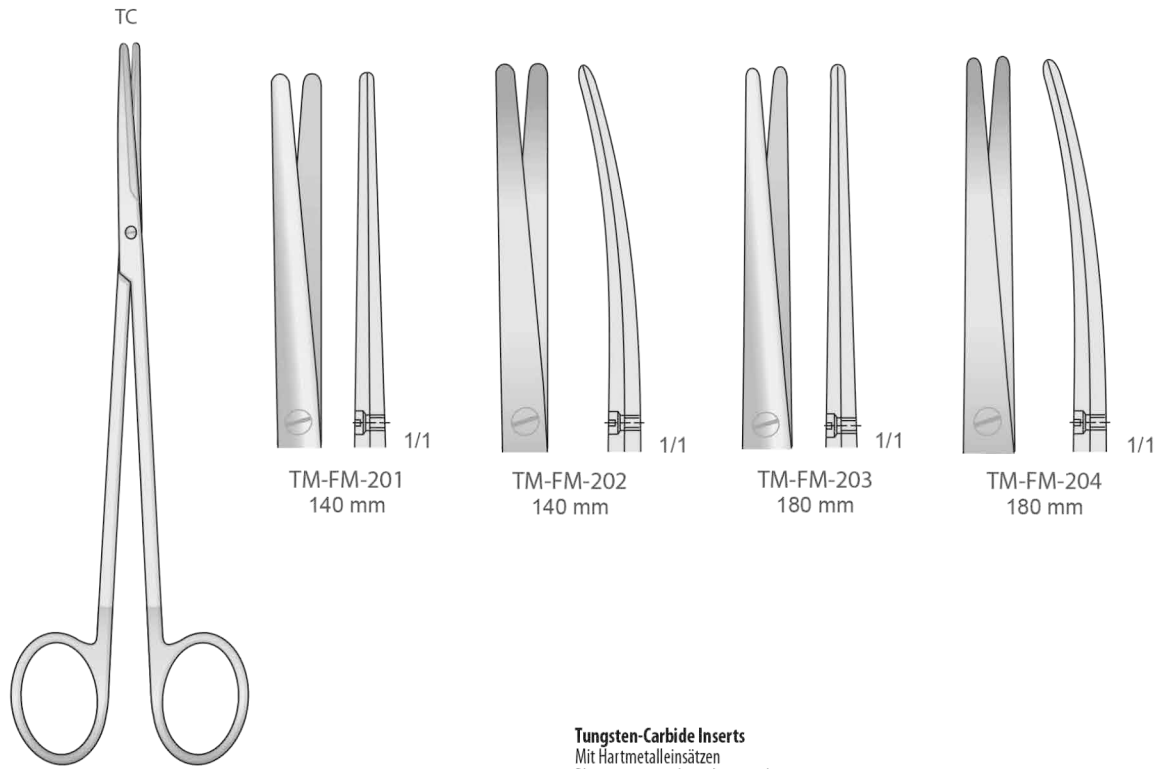
METZENBAUM  
TM-FM-68/TM-FM-69  
185 mm



METZENBAUM  
TM-FM-3/TM-FM-4  
185 mm



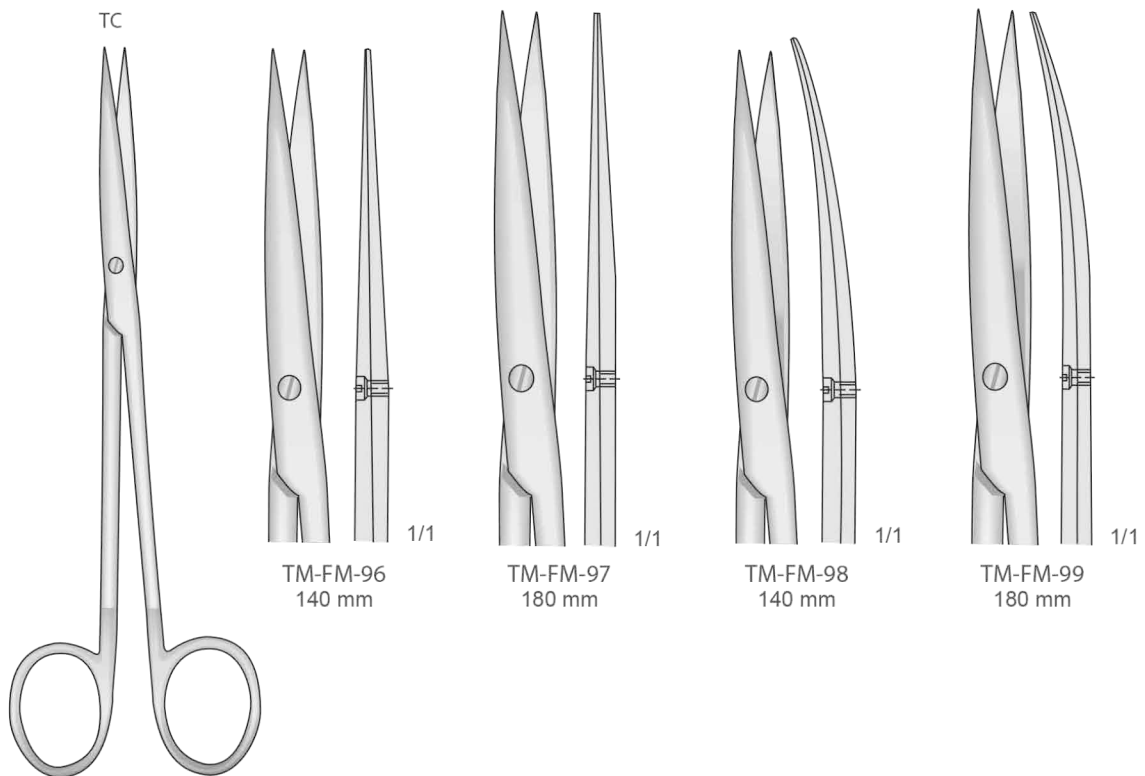
METZENBAUM-FINO  
TM-FM-3F/TM-FM-4F  
185 mm



METZENBAUM-FINO  
TM-FM-201/TM-FM-204

**Tungsten-Carbide Inserts**

Mit Hartmetalleinsätzen  
Plaquettes en carbure de tungstène  
Plaquetas de carburo de tungsteno  
Inserti in carburo di tungsteno

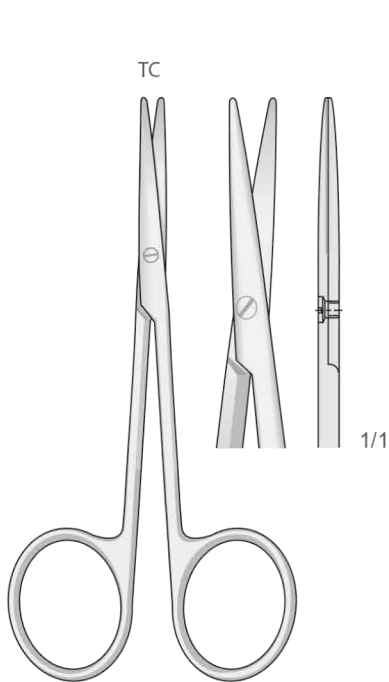


METZENBAUM-FINO  
TM-FM-96/TM-FM-99

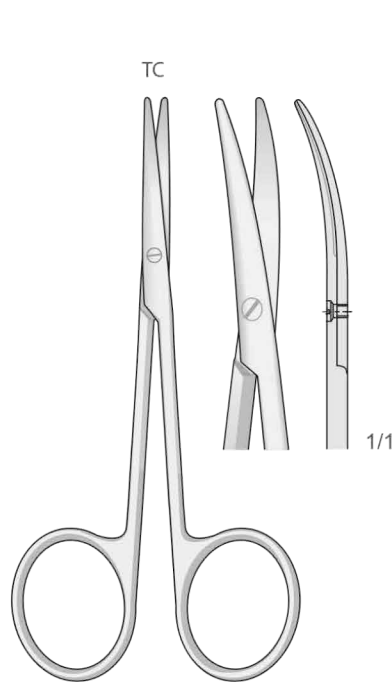


Scheren  
Scissors  
Forbici  
Tijeras  
Ciseaux

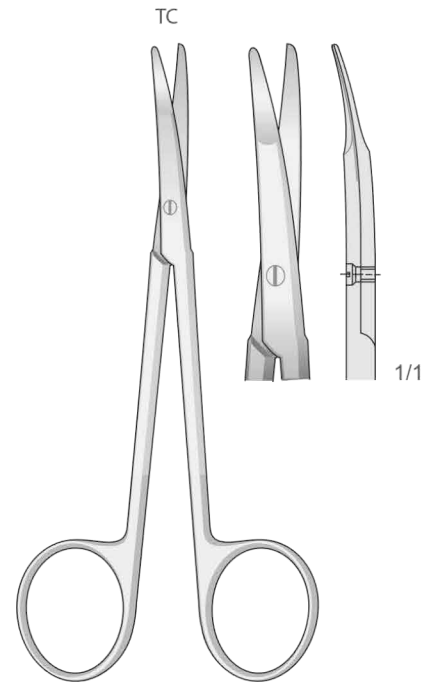
**Tungsten-Carbide Inserts**  
Mit Hartmetalleinsätzen  
Plaquettes en carbure de tungstène  
Plaquetas de carburo de tungsteno  
Inserti in carburo di tungsteno



LEXER-BABY (KNAPP)  
TM-FM-118  
115 mm

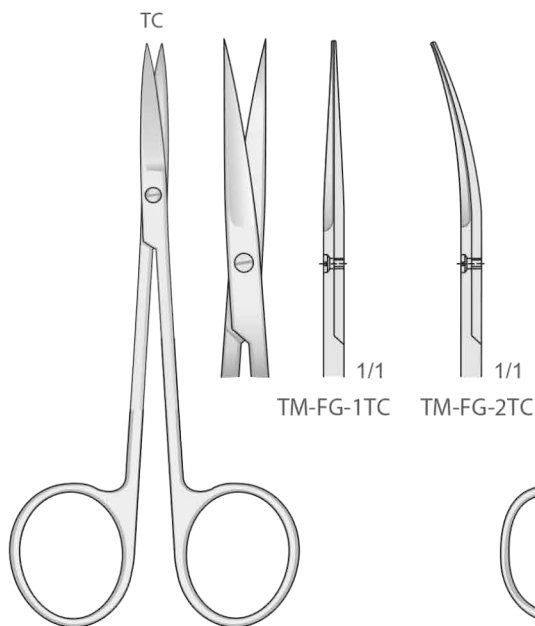


LEXER-BABY (KNAPP)  
TM-FM-119  
115 mm

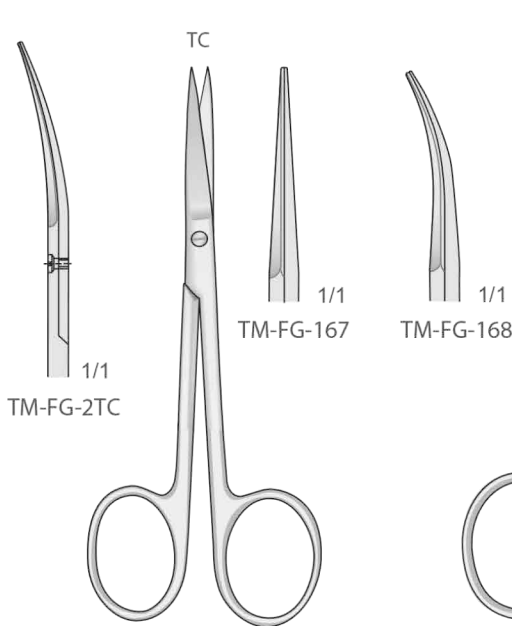


KILNER  
TM-FM-350  
125 mm

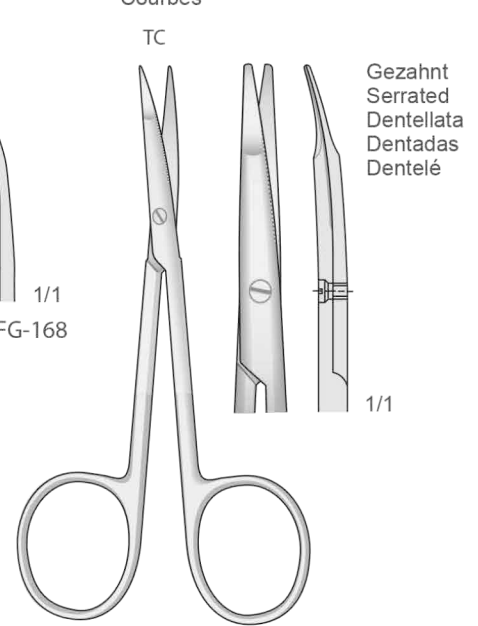
Gebogen - Curved  
Curva - Curvas  
Courbes



IRIS  
TM-FG-1TC/TM-FG-2TC  
115 mm

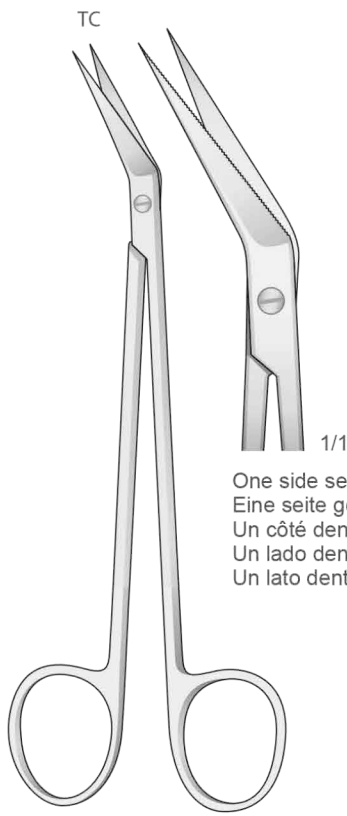


TM-FG-167/TM-FG-168  
110 mm



GREENBERG-PAR  
TM-FM-317  
115 mm

Gezant  
Serrated  
Dentellata  
Dentadas  
Dentelé

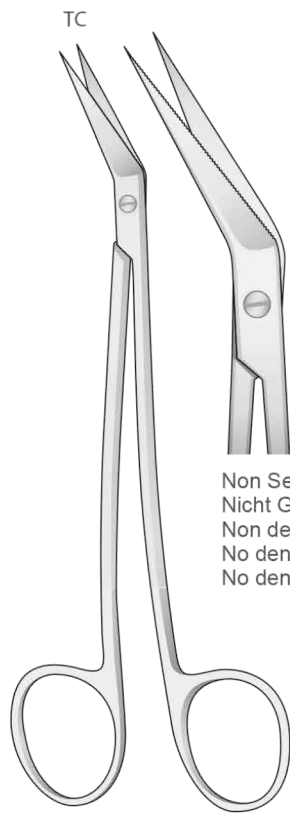


TC

1/1

One side serrated  
Eine seite gezahnt  
Un côté dentelé  
Un lado dentado  
Un lato dentellato

TM-LK-10  
160 mm



TC

1/1

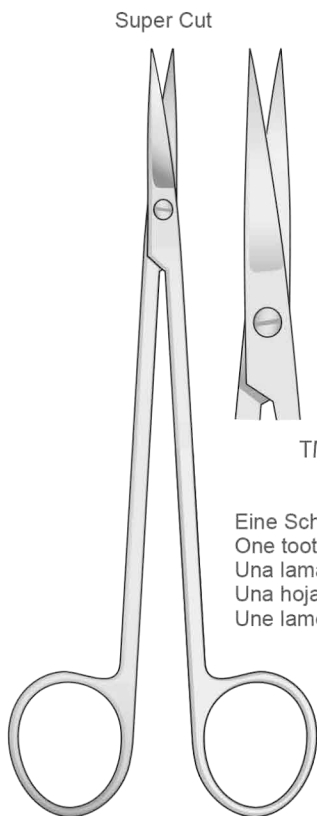
Non Serrated  
Nicht Gezahnt  
Non dentelé  
No dentado  
No dentellato

TM-LK-12  
160 mm

**Tungsten-Carbide Inserts**

Mit Hartmetalleinsätzen  
Plaquettes en carbure de tungstène  
Plaquetas de carburo de tungsteno  
Inseri in carburo di tungsteno

Eine Schneide gezahnt S-förmig gebogen  
One toothed cutting edge S-shaped  
Una lama dentata curva a forma S  
Una hoja dentada forma S  
Une lame dentelée courbés en S



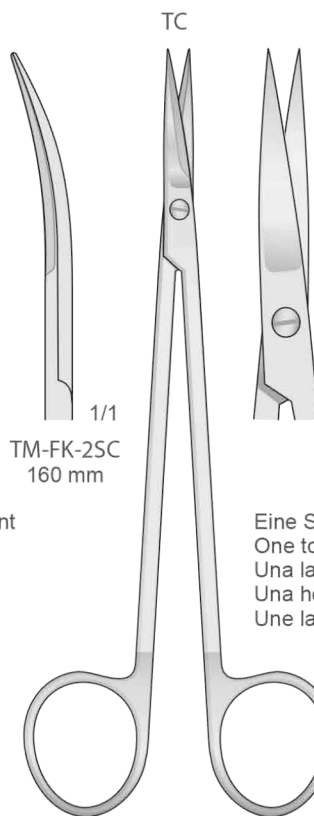
Super Cut

1/1

TM-FK-1SC  
160 mm

Eine Schneide gezahnt  
One toothed cutting  
Una lama dentata  
Una hoja dentada  
Une lame dentelé

KELLY  
TM-FK-1SC/TM-FK-2SC  
160 mm



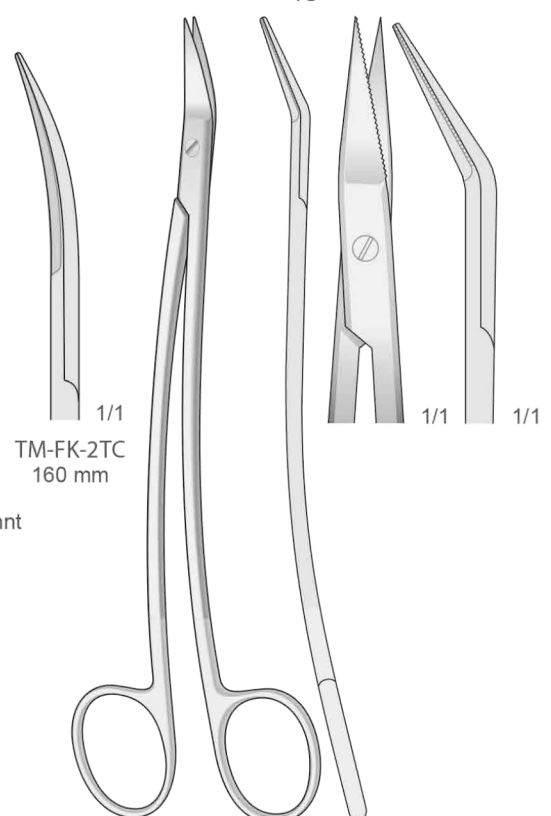
TC

1/1

TM-FK-1TC  
160 mm

Eine Schneide gezahnt  
One toothed cutting  
Una lama dentata  
Una hoja dentada  
Une lame dentelé

KELLY  
TM-FK-1TC / TM-FK-2TC  
160 mm



TC

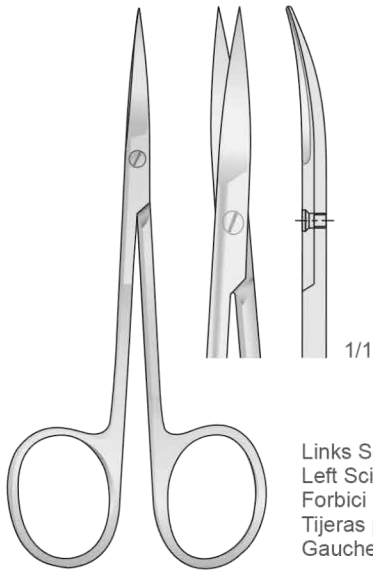
1/1

1/1

DEAN-TC  
175 mm

Scheren  
Scissors  
Forbici  
Tijeras  
Ciseaux

Wellenschliff  
TC

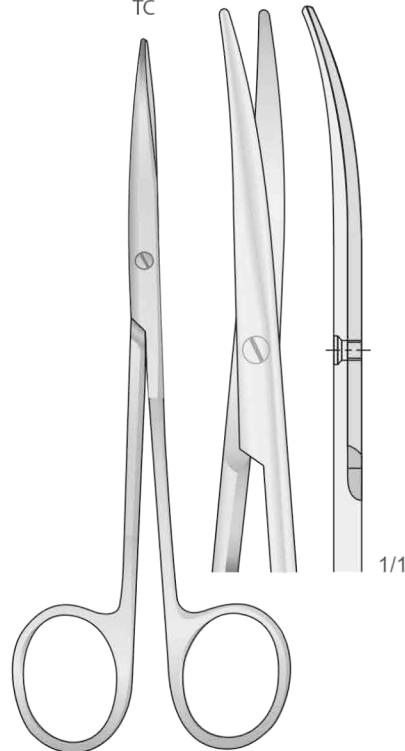


Links Scheren  
Left Scissors  
Forbici per mancini  
Tijeras para zurdos  
Gauche Ciseaux

IRIS  
TM-FM-100L  
110 mm

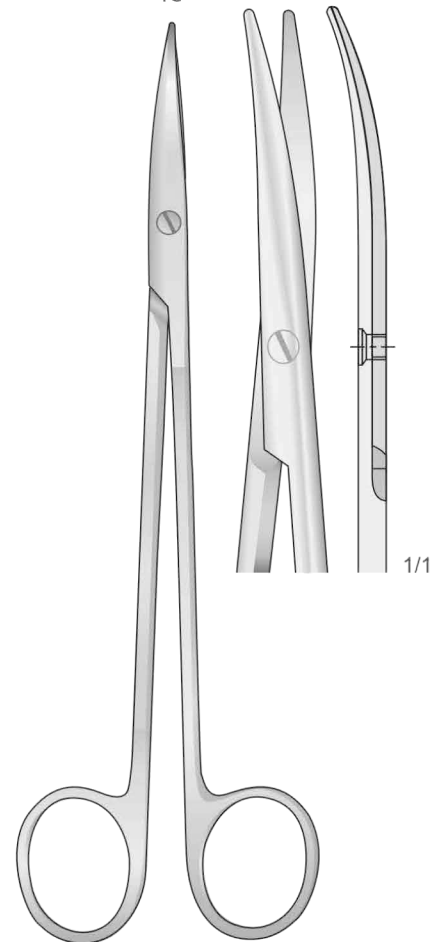
**Tungsten-Carbide Inserts**  
Mit Hartmetalleinsätzen  
Plaquettes en carbure de tungstène  
Plaquetas de carburo de tungsteno  
Inserti in carburo di tungsteno

Wellenschliff  
TC



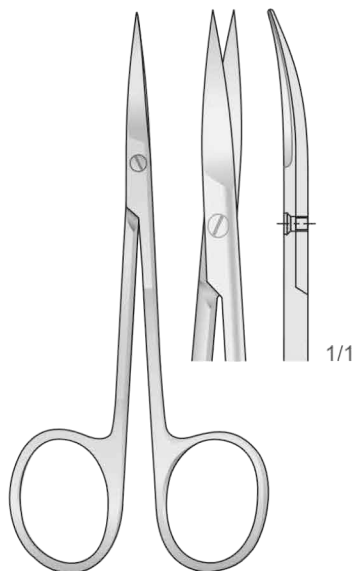
METZENBAUM  
TM-FM-102  
145 mm

Wellenschliff  
TC



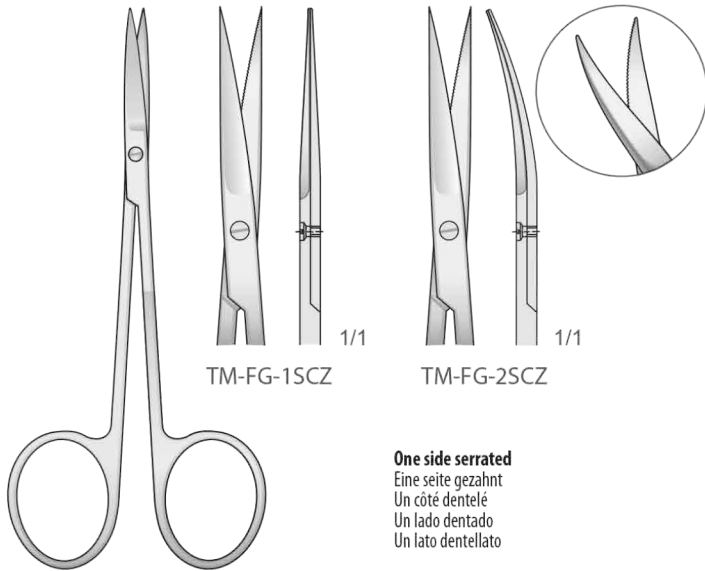
METZENBAUM  
TM-FM-104  
185 mm

Wellenschliff  
TC



IRIS  
TM-FM-100  
110 mm

**Extremely Sharp Razor Edge / Atraumatic**  
Extrem Scharfe Spitzer Beck / Atraumatische  
Tranchant extrêmement aiguisée / Atraumatique  
Borde extremadamente afilado / Atraumática  
Taglio estremamente affilato / Atraumatica

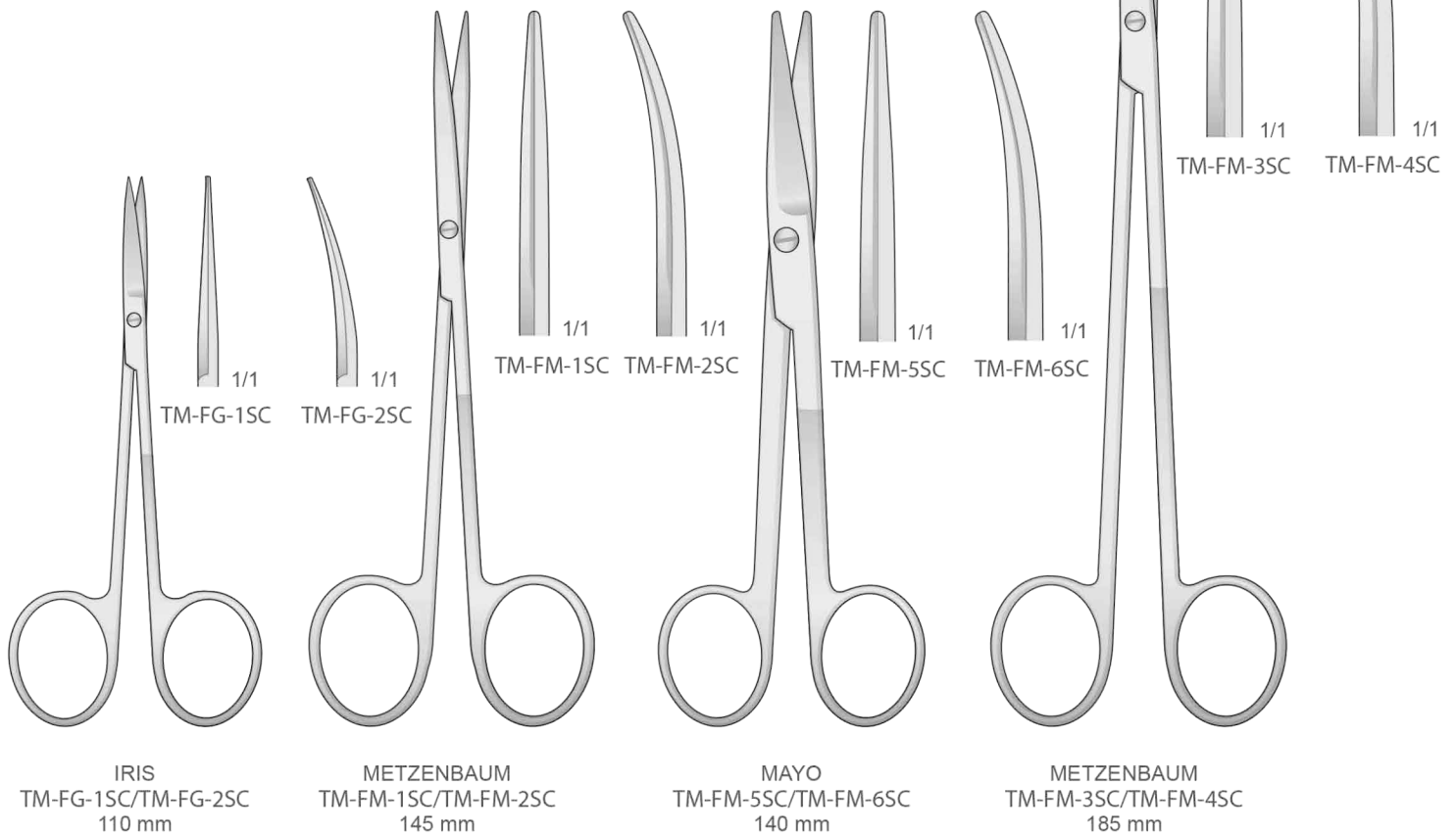


TM-FG-1SCZ

TM-FG-2SCZ

**One side serrated**  
Eine seite gezahnt  
Un côté dentelé  
Un lado dentado  
Un lato dentellato

TM-FG-1SCZ/TM-FG-2SCZ  
110 mm



TM-FG-1SC

TM-FG-2SC

TM-FM-1SC

TM-FM-2SC

TM-FM-5SC

TM-FM-6SC

TM-FM-3SC

TM-FM-4SC

IRIS  
TM-FG-1SC/TM-FG-2SC  
110 mm

METZENBAUM  
TM-FM-1SC/TM-FM-2SC  
145 mm

MAYO  
TM-FM-5SC/TM-FM-6SC  
140 mm

METZENBAUM  
TM-FM-3SC/TM-FM-4SC  
185 mm

Scheren  
Scissors  
Forbici  
Tijeras  
Ciseaux

**SUPER CUT**

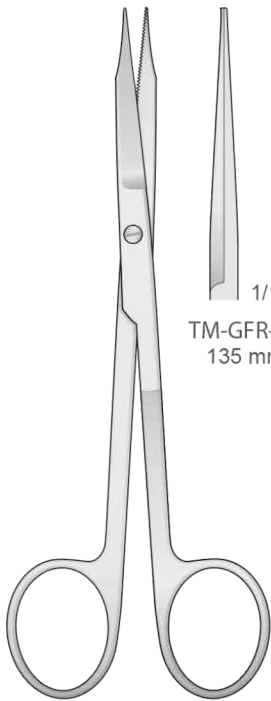
Regular Edge

SUPER CUT Edge

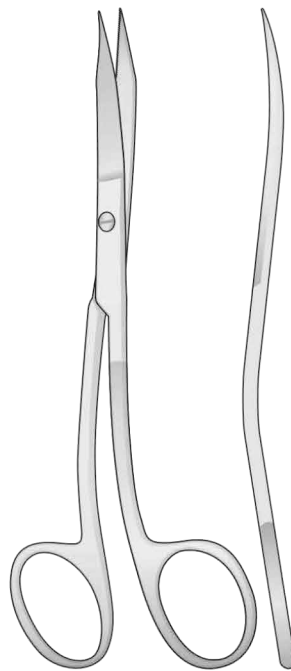
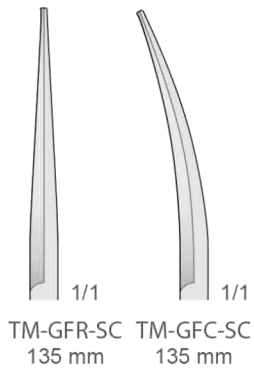
Super Cut Scissors have specially designed cutting edges.  
One regular edge and one sharp-knife edge.

**Extremely Sharp Razor Edge / Atraumatic**  
Extrem Scharfe Spitzer Beck / Atraumatische  
Tranchant extrêmement aiguisée / Atraumatique  
Borde extremadamente afilado / Atraumática  
Taglio estremamente affilato / Atraumatica

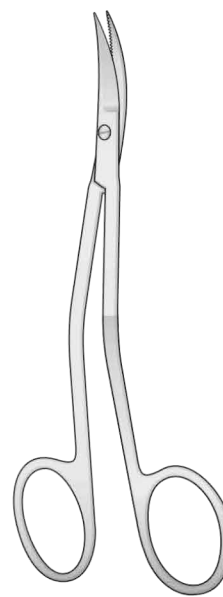
**One side serrated**  
Eine seite gezahnt  
Un côté dentelé  
Un lado dentado  
Un lato dentellato



GOLDMAN-FOX  
TM-GFR-SC/TM-GFC-SC  
135 mm



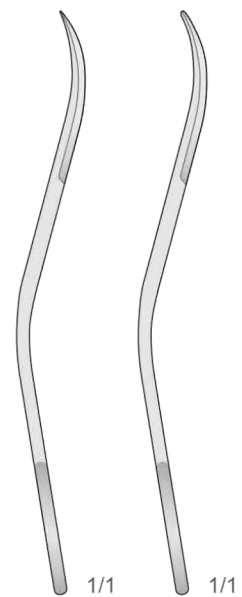
GOLDMAN-FOX S FORM  
GFS-SC  
130 mm



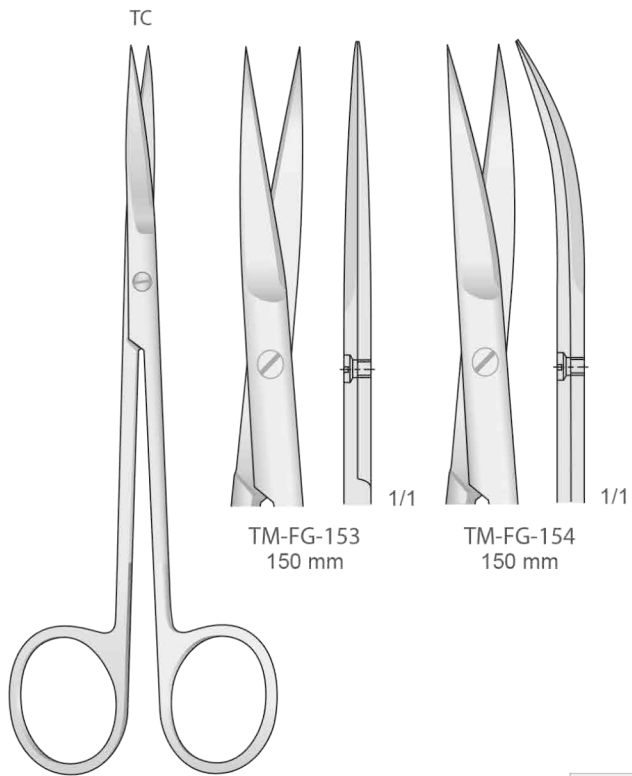
LA GRANGE  
TM-LG-1SC/TM-LG-2SC  
115 mm

Spitz  
Sharp  
Acute  
Agudas  
Pointu

Stumpf  
Blunt  
Smusse  
Romas  
Mousse



LA GRANGE      LA GRANGE  
TM-LG-1SC      TM-LG-2SC



JOSEPH  
TM-FG-153/TM-FG-154  
150 mm

**TC**  
TUNGSTEN  
CARBIDE

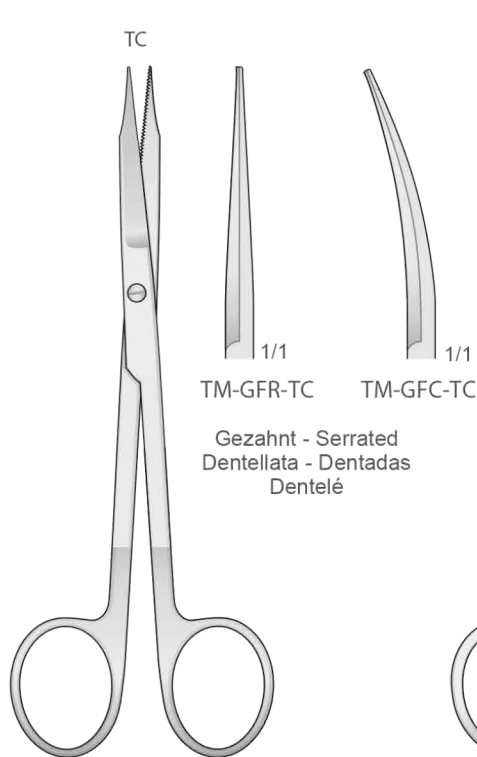
**Tungsten-Carbide Inserts**  
Mit Hartmetalleinsätzen  
Plaquettes en carbure de tungstène  
Plaquetas de carburo de tungsteno  
Inserti in carburo di tungsteno

**ONE SIDE  
SERRATED**

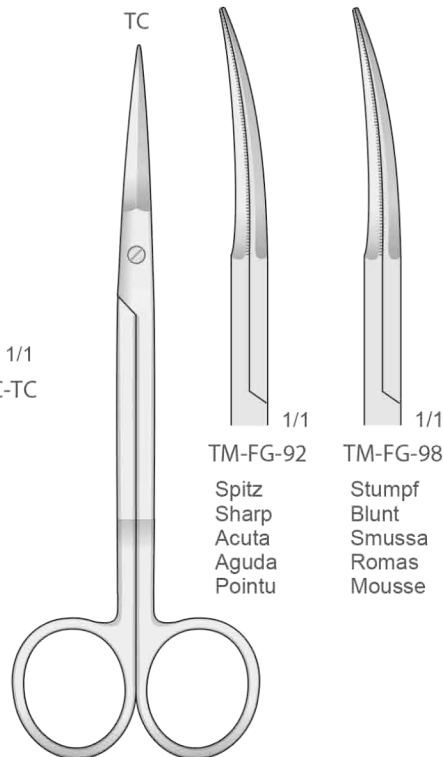
**One side serrated**  
Eine Seite gezahnt  
Un côté dentelé  
Un lado dentado  
Un lato dentellato

**ONE SIDE  
SERRATED**

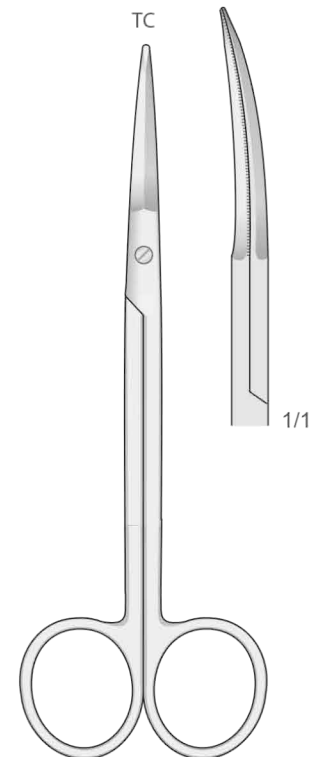
**One side serrated**  
Eine Seite gezahnt  
Un côté dentelé  
Un lado dentado  
Un lato dentellato



GOLDMAN-FOX  
TM-GFC-TC/TM-GFR-TC  
135 mm

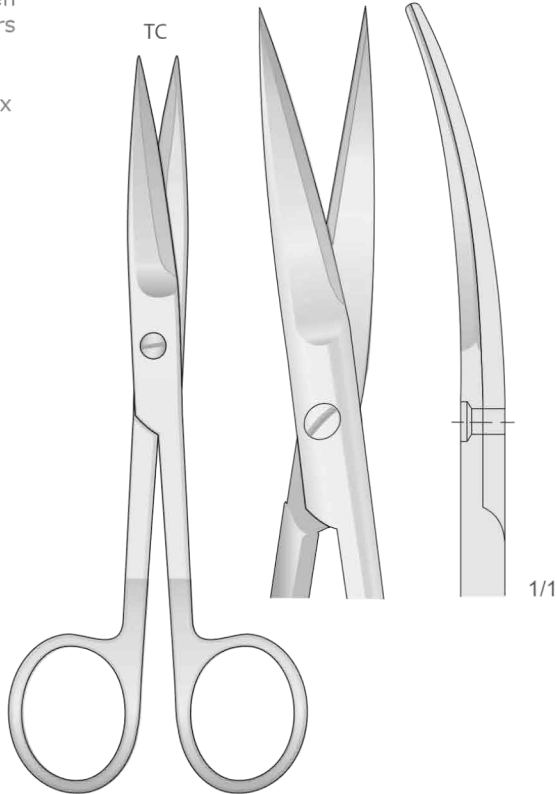


PECK-JOSEPH  
TM-FG-92/TM-FG-98  
140 mm



GREGORY  
TM-FM-339  
140 mm

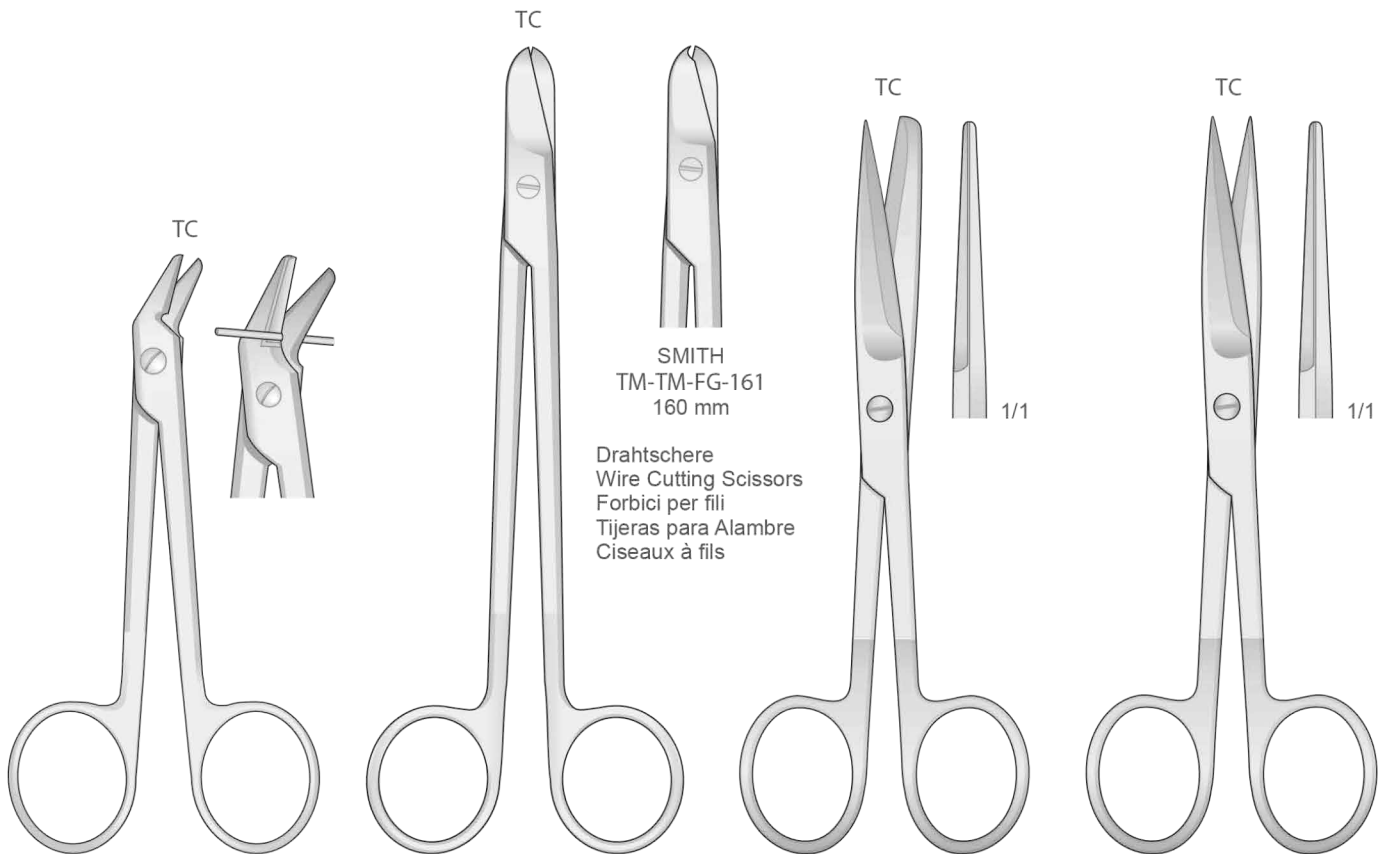
Scheren  
Scissors  
Forbici  
Tijeras  
Ciseaux



**TC**  
TUNGSTEN  
CARBIDE

**Tungsten-Carbide Inserts**  
Mit Hartmetalleinsätzen  
Plaquettes en carbure de tungstène  
Plaquetas de carburo de tungsteno  
Inserti in carburo di tungsteno

TM-FM-146  
145 mm



SMITH  
TM-TM-FG-161  
160 mm

Drahtschere  
Wire Cutting Scissors  
Forbici per fili  
Tijeras para Alambre  
Ciseaux à fils

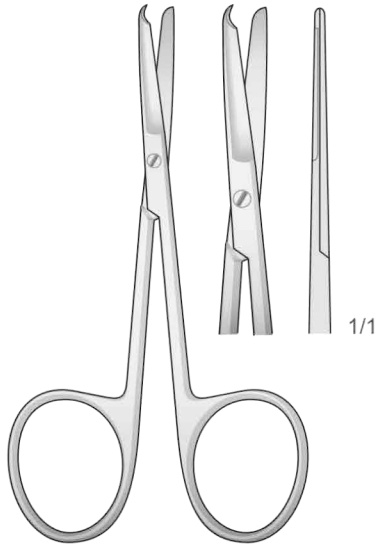
TM-DP-120  
120 mm

SMITH  
TM-FG-160  
160 mm

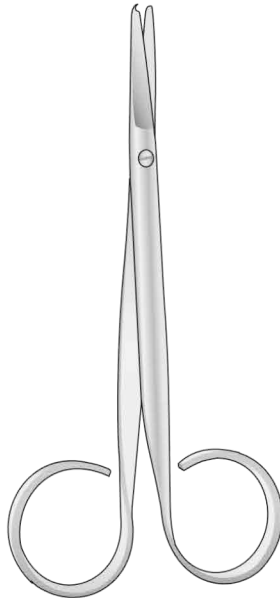
TM-FM-51  
145 mm

TM-FM-59  
145 mm

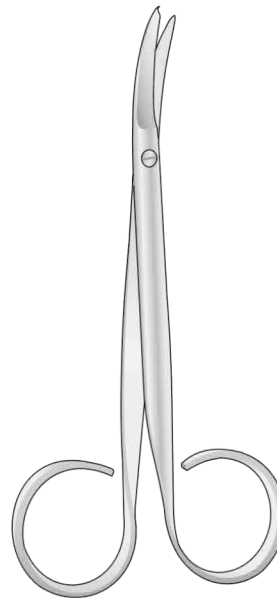
Ligatur Scheren  
Ligature Scissors  
Forbici per legature  
Tijeras para ligaduras  
Ciseaux à ligatures



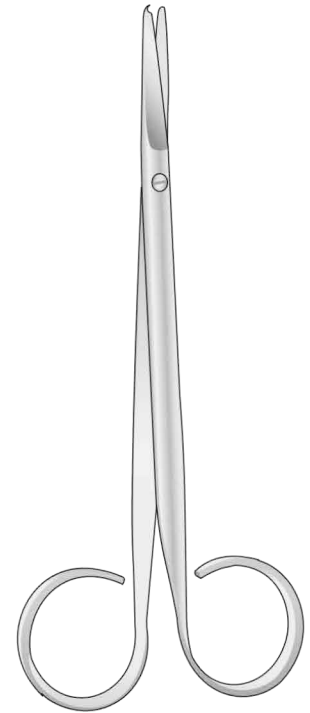
SPENCER  
TM-SC-9  
90 mm



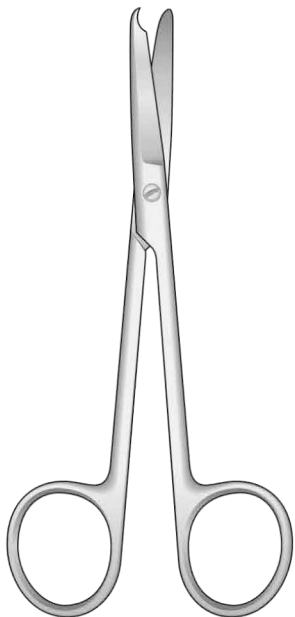
SPENCER  
TM-SC-1  
110 mm



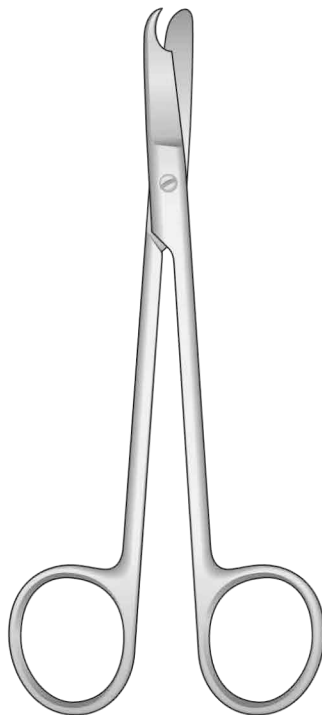
SPENCER  
TM-SC-5  
110 mm



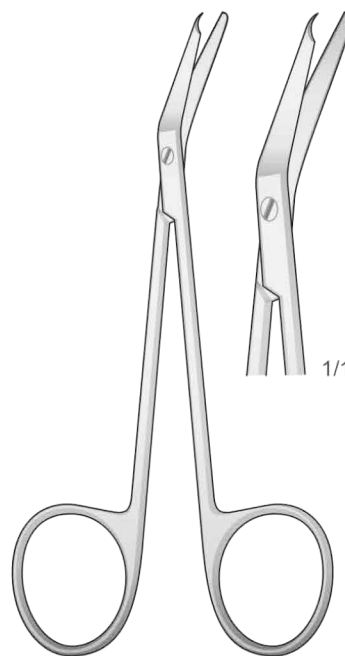
SPENCER  
TM-SC-2  
145 mm



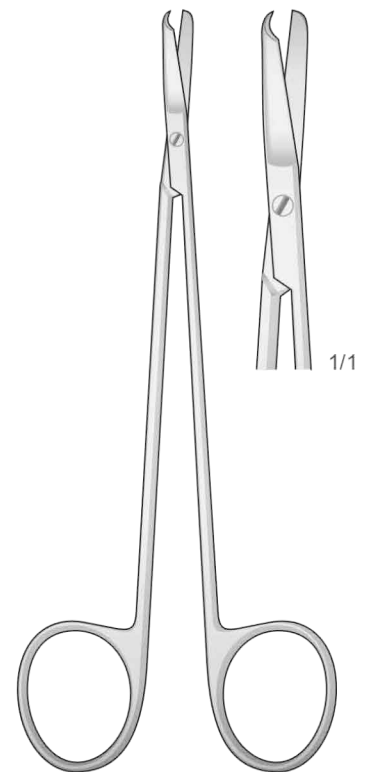
SPENCER  
TM-SC-14  
120 mm



LITTAUER  
TM-SC-15  
140 mm



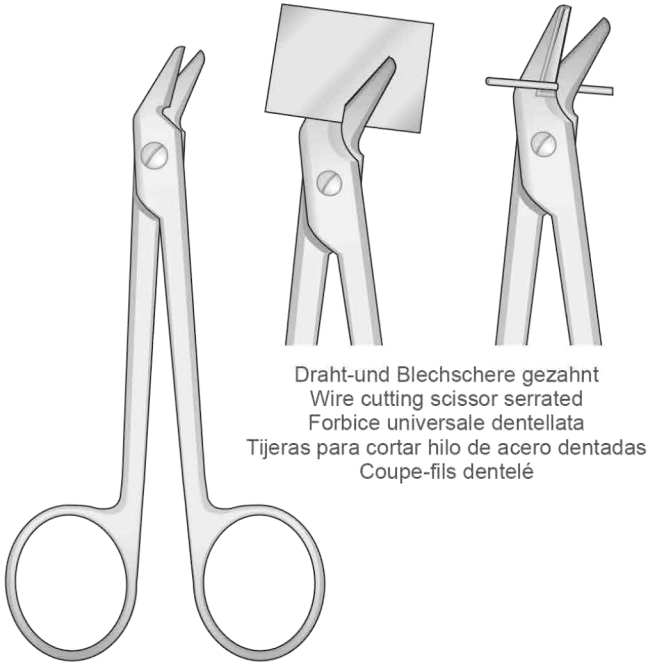
SPENCER  
TM-SC-13  
130 mm



KELLY  
TM-SC-16  
150 mm

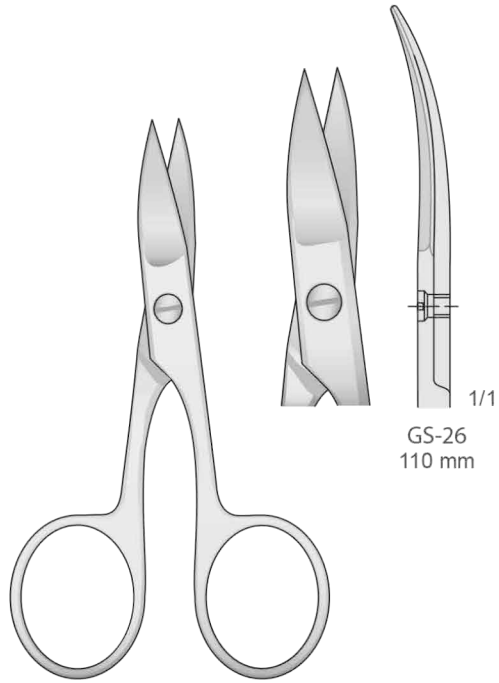


Draht und blechscheren  
Wire and plate cutting scissors  
Forbici per fili metallici  
Tijeras para cortar alambre  
Ciseaux coupe-fils métalliques



Draht-und Blechschere gezahnt  
Wire cutting scissor serrated  
Forbice universale dentellata  
Tijeras para cortar hilo de acero dentadas  
Coupe-fils dentelé

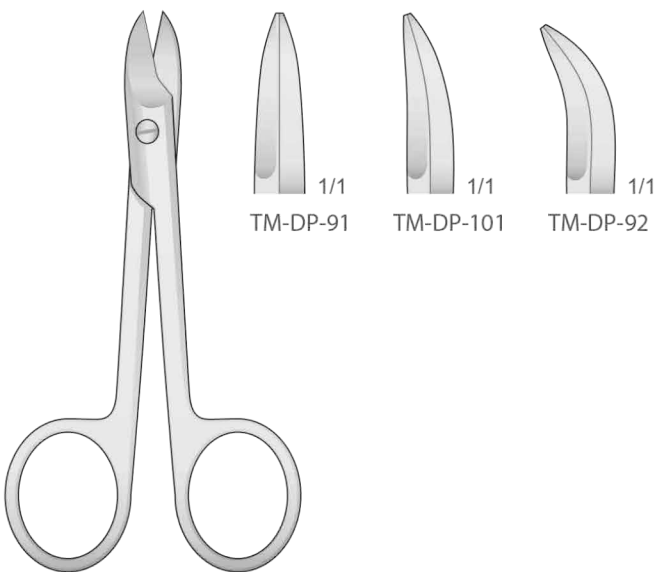
TM-DP-90  
120 mm



GS-26  
110 mm

GS-26  
110 mm

Spitz  
Sharp  
Acute  
Agudas  
Pointu



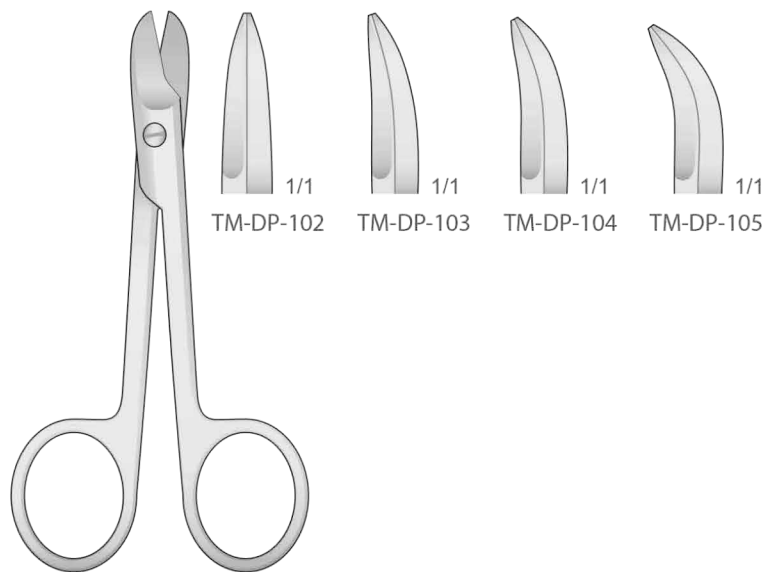
TM-DP-91

TM-DP-101

TM-DP-92

BEEBE  
TM-DP-91/TM-DP-101  
110 mm

Stumpf  
Blunt  
Smusse  
Romas  
Mousse



TM-DP-102

TM-DP-103

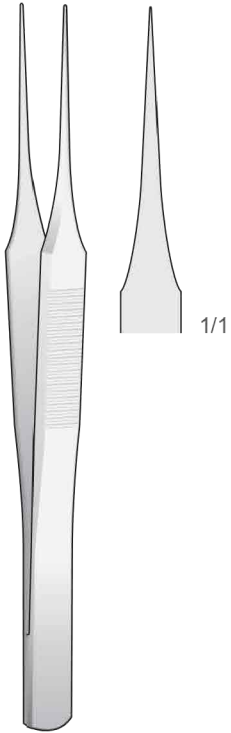
TM-DP-104

TM-DP-105

BEEBE  
TM-DP-102/TM-DP-105  
110 mm

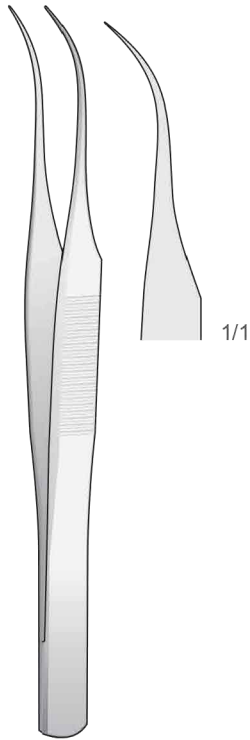
Mikro Pinzetten  
Delicate Forceps  
Micro Pinzette  
Pinzas finas  
Micro Pincas

0,2 mm



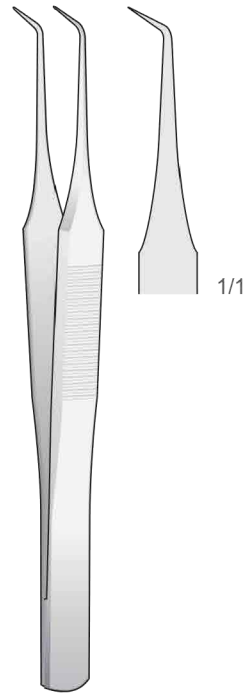
TM-BD-360  
110 mm

0,3 mm



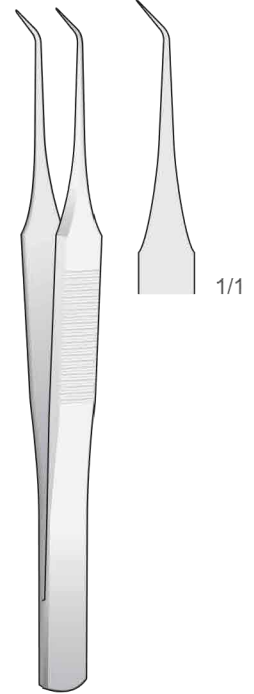
TM-BD-361  
110 mm

0,25 mm



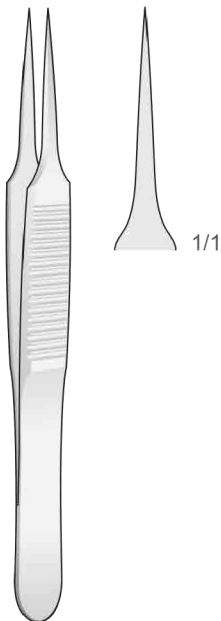
TM-BD-362  
100 mm

0,15 mm



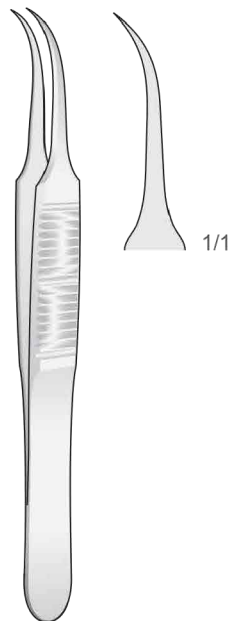
TM-BD-363  
100 mm

0,4 mm



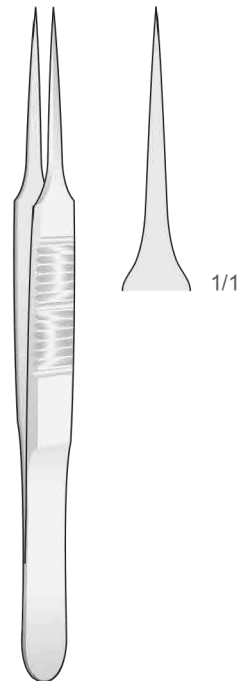
TM-BD-364  
110 mm

0,4 mm



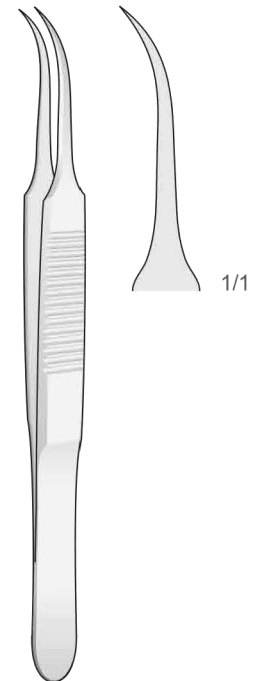
TM-BD-365  
110 mm

0,4 mm



TM-BD-366  
130 mm

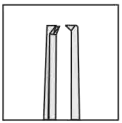
0,4 mm



TM-BD-367  
130 mm

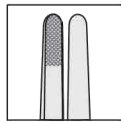
**Diamond Tip**  
Diamantiert  
Punta diamantata  
Punta de diamante  
Pointe de diamant

Tissue Forceps  
1x2 Teeth



BISHOP-HARMON  
TM-MF-177 1,2 mm  
85 mm

Dressing Forceps  
criss-cross serrated tips



BISHOP-HARMON  
TM-MF-249 1,2 mm  
85 mm

8



1/1  
1x2 Zähne  
1x2 Teeth  
1x2 Denti  
1x2 Dientes  
1x2 Dents

CASTROVIEJO  
TM-BD-348 0,9 mm  
120 mm

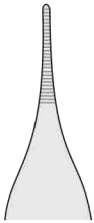
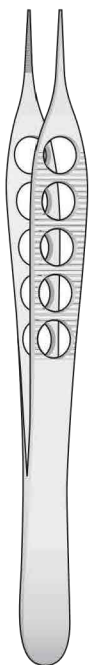


1/1  
9x9 Zähne  
9x9 Teeth  
9x9 Denti  
9x9 Dientes  
9x9 Dents



BROWN  
TM-BD-349  
120 mm

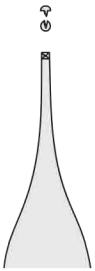
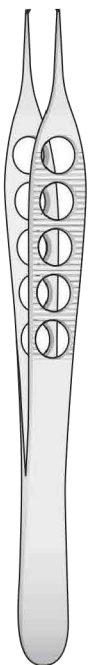
1,2 mm



1/1

ADSON  
TM-BD-207  
120 mm

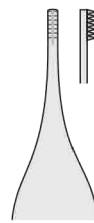
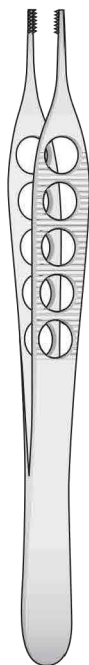
1,2 mm



1/1

ADSON  
TM-BD-208  
120 mm

8

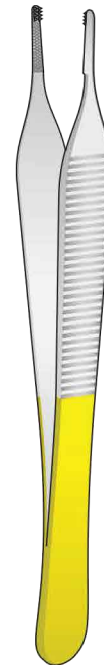


1/1

7x7 Zähne  
7x7 Teeth  
7x7 Denti  
7x7 Dientes  
7x7 Dents

ADSON-BROWN  
TM-BD-209  
120 mm

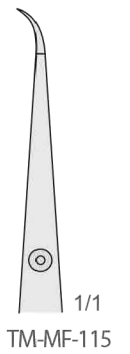
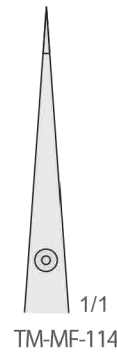
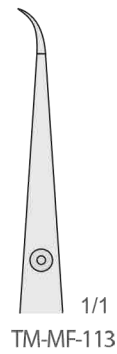
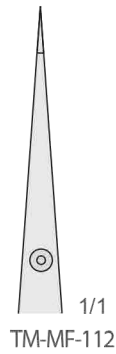
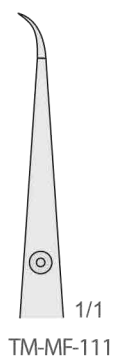
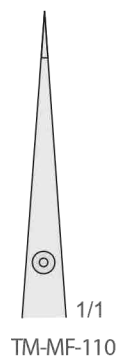
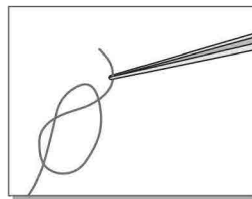
TC



1/1

ADSON-BROWN  
TM-BD-253  
120 mm

Mikro Pinzetten  
Delicate Forceps  
Micro Pinzette  
Pinzas finas  
Micro Pinces



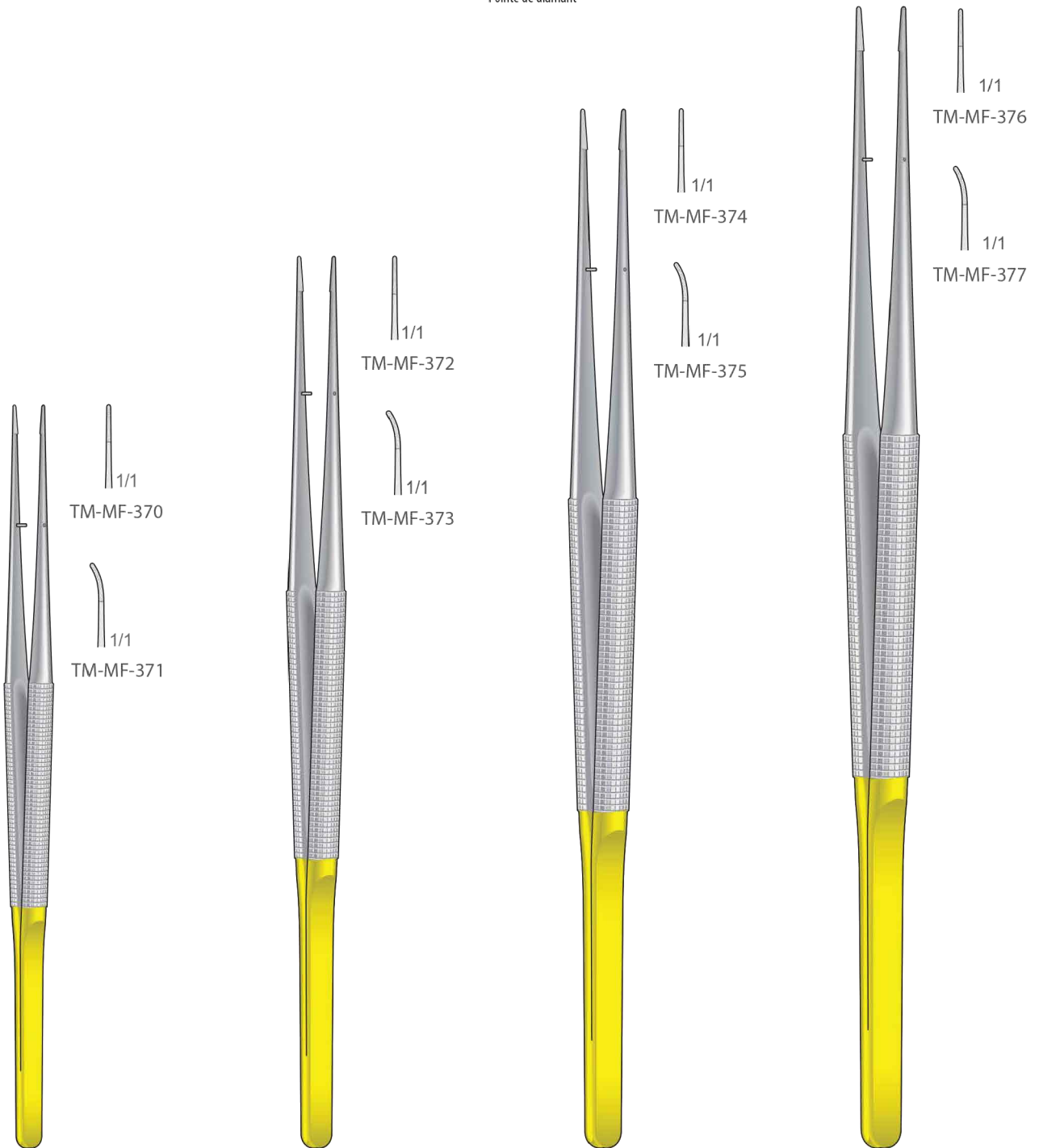
TM-MF-110/TM-MF-111  
120 mm

TM-MF-112/TM-MF-113  
150 mm

TM-MF-114/TM-MF-115  
180 mm

Mikro Pinzette - Rundgriff Ø 8 mm  
Mit Führungsstift diamantiert  
Fadenplatte 6x0,7 mm

**Diamond Tip**  
Diamantiert  
Punta diamantata  
Punta de diamante  
Pointe de diamant



TM-MF-370/TM-MF-371  
150 mm

TM-MF-372/TM-MF-373  
180 mm

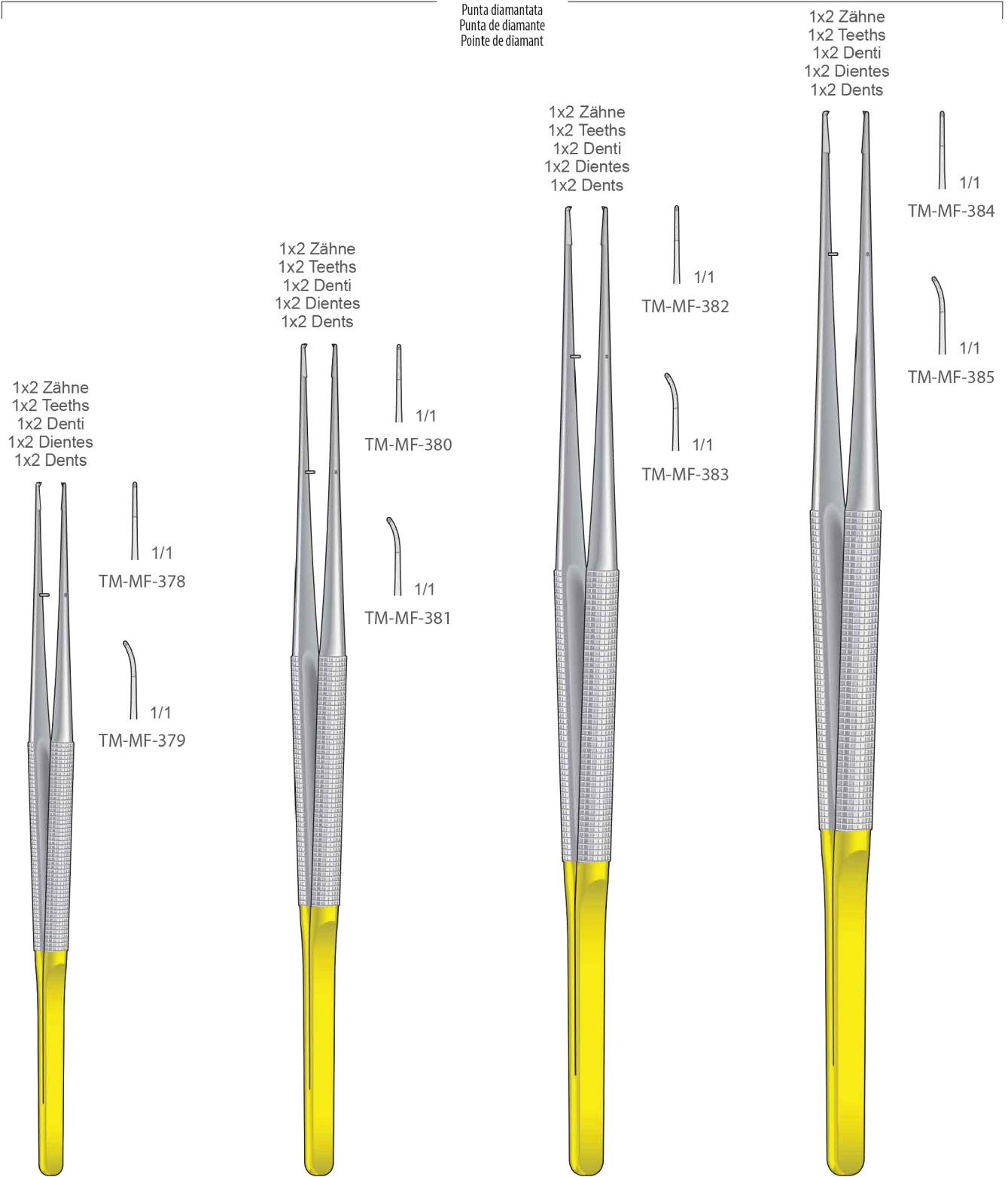
TM-MF-374/TM-MF-375  
210 mm

TM-MF-376/TM-MF-377  
230 mm

Mikro Pinzetten  
Micro Forceps  
Micro Pinzette  
Micro Pinzas  
Micro Pince

Mikro Pinzette - Rundgriff Ø 8 mm  
Mit Führungsstift diamantiert  
Fadenplatte 6x0,7 mm

**Diamond Tip**  
Diamantiert  
Punta diamantata  
Punta de diamante  
Pointe de diamant



1x2 Zähne  
1x2 Teeths  
1x2 Denti  
1x2 Dientes  
1x2 Dents

TM-MF-378

TM-MF-379

1x2 Zähne  
1x2 Teeths  
1x2 Denti  
1x2 Dientes  
1x2 Dents

TM-MF-380

TM-MF-381

1x2 Zähne  
1x2 Teeths  
1x2 Denti  
1x2 Dientes  
1x2 Dents

TM-MF-382

TM-MF-383

1x2 Zähne  
1x2 Teeths  
1x2 Denti  
1x2 Dientes  
1x2 Dents

TM-MF-384

TM-MF-385

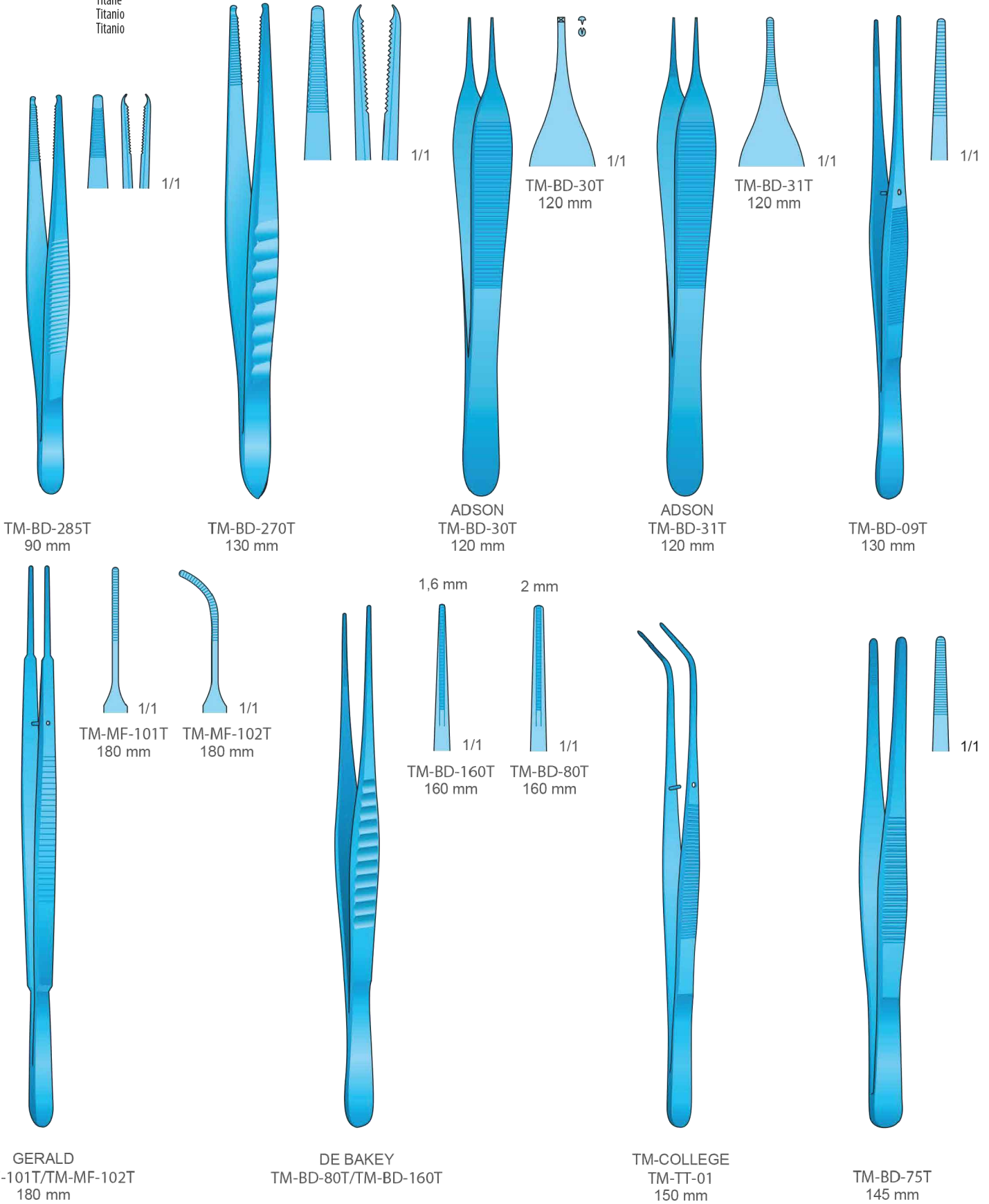
TM-MF-378/TM-MF-379  
150 mm

TM-MF-380/TM-MF-381  
180 mm

TM-MF-382/TM-MF-383  
210 mm

TM-MF-384/TM-MF-385  
230 mm

Titanium  
Titan  
Titane  
Titanio  
Titano



TM-BD-285T  
90 mm

TM-BD-270T  
130 mm

ADSON  
TM-BD-30T  
120 mm

ADSON  
TM-BD-31T  
120 mm

TM-BD-09T  
130 mm

TM-MF-101T  
180 mm

TM-MF-102T  
180 mm

TM-BD-160T  
160 mm

TM-BD-80T  
160 mm

GERALD  
TM-MF-101T/TM-MF-102T  
180 mm

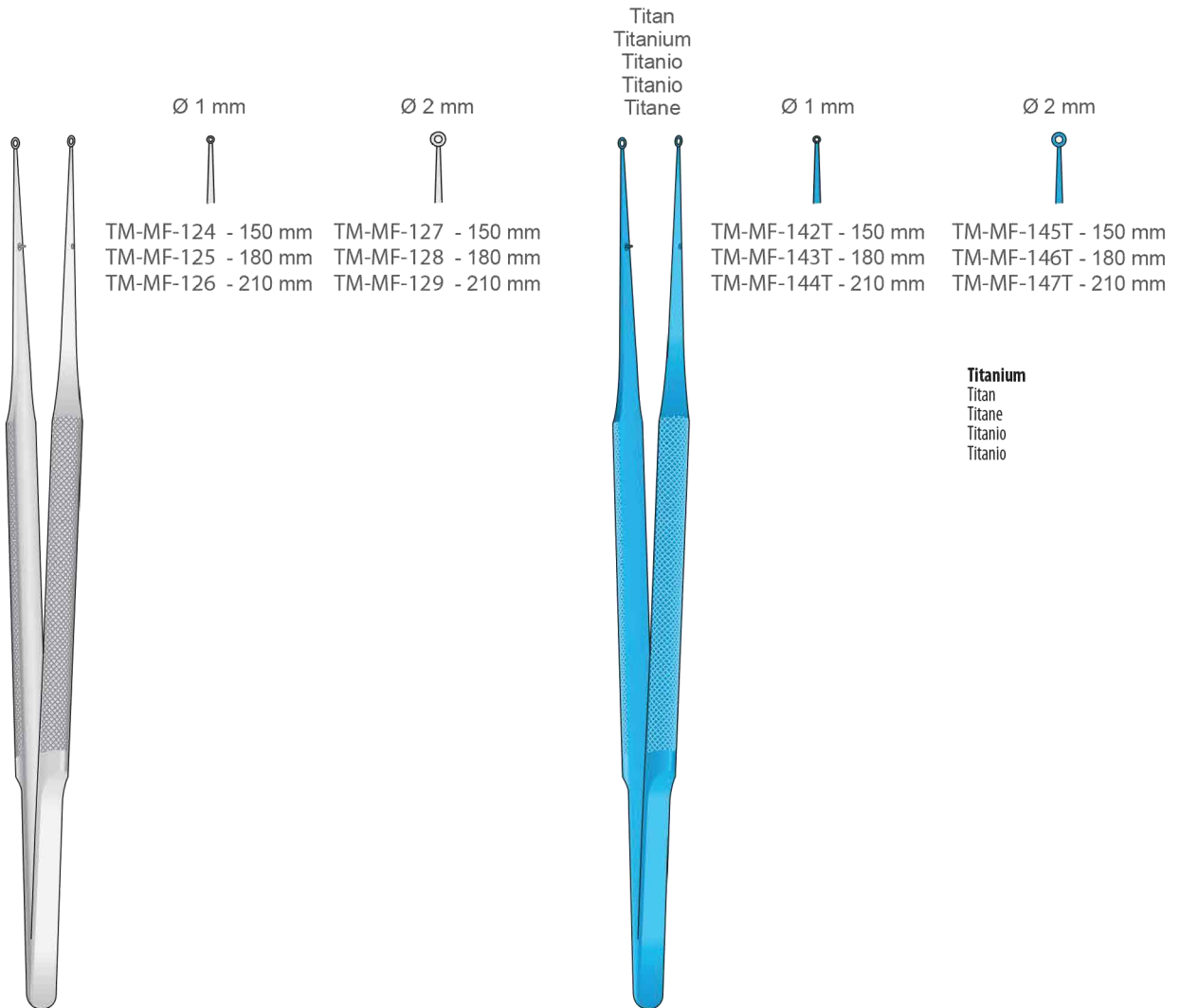
DE BAKEY  
TM-BD-80T/TM-BD-160T

TM-COLLEGE  
TM-TT-01  
150 mm

TM-BD-75T  
145 mm

Mikro Pinzetten  
Delicate Forceps  
Micro Pinzette  
Pinzas finas  
Micro Pincers

Rund-Griffe Ø 8 mm  
Round handle Ø 8 mm  
Manico rotondo Ø 8 mm  
Mango redondo Ø 8 mm  
Manche rond Ø 8 mm



Ø 1 mm                      Ø 2 mm

TM-MF-124 - 150 mm    TM-MF-127 - 150 mm  
TM-MF-125 - 180 mm    TM-MF-128 - 180 mm  
TM-MF-126 - 210 mm    TM-MF-129 - 210 mm

Titan  
Titanium  
Titanio  
Titane

Ø 1 mm                      Ø 2 mm

TM-MF-142T - 150 mm    TM-MF-145T - 150 mm  
TM-MF-143T - 180 mm    TM-MF-146T - 180 mm  
TM-MF-144T - 210 mm    TM-MF-147T - 210 mm

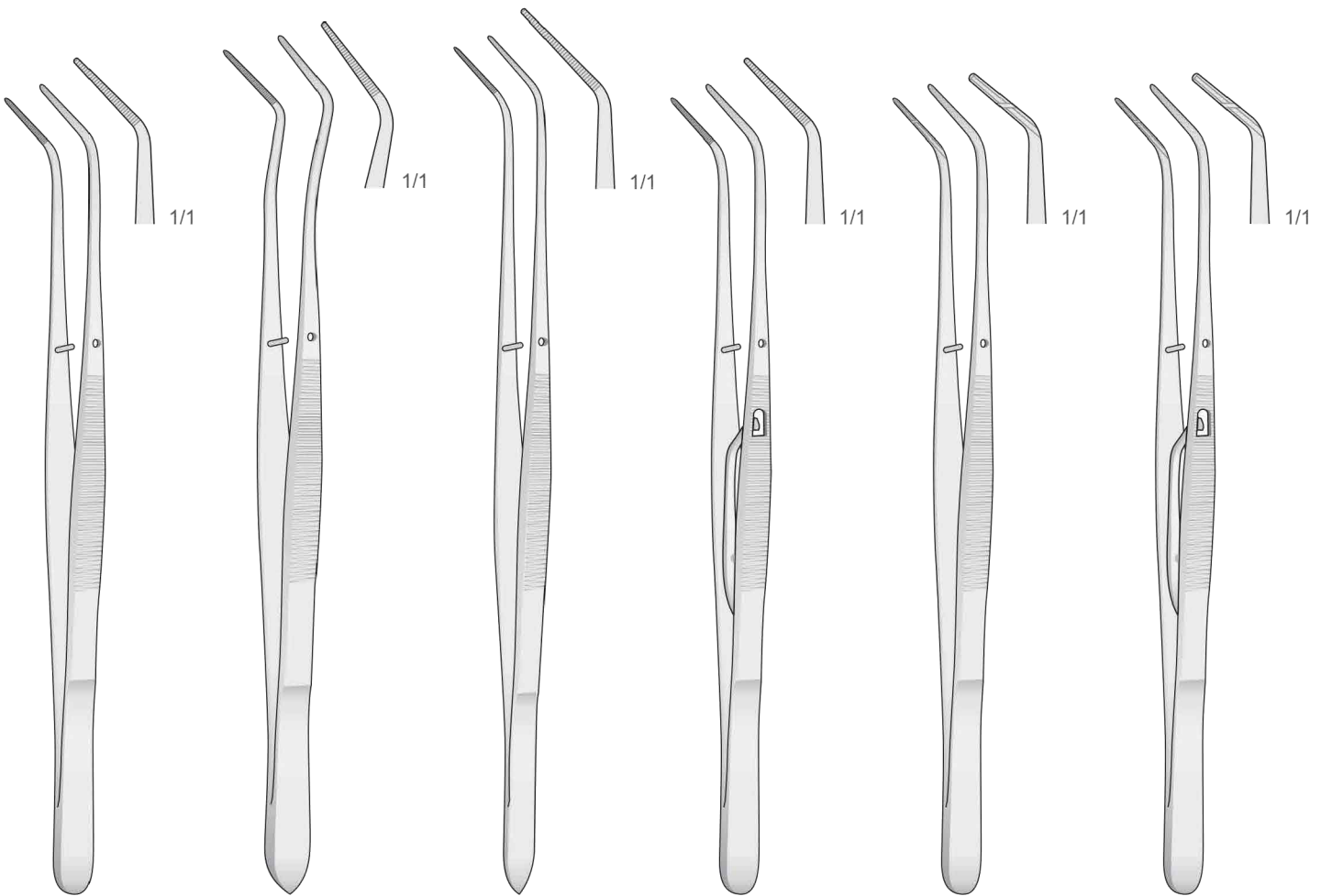
**Titanium**  
Titan  
Titane  
Titanio

TM-MF-124/TM-MF-129

TM-MF-142T/TM-MF-147T



Zahnpinzetten  
Cotton and Dressing Pliers  
Pinzette per medicazione  
Pinzas para vendajes  
Précèlles pour cotton



TM-COLLEGE  
150 mm

TM-MERIAM  
160 mm

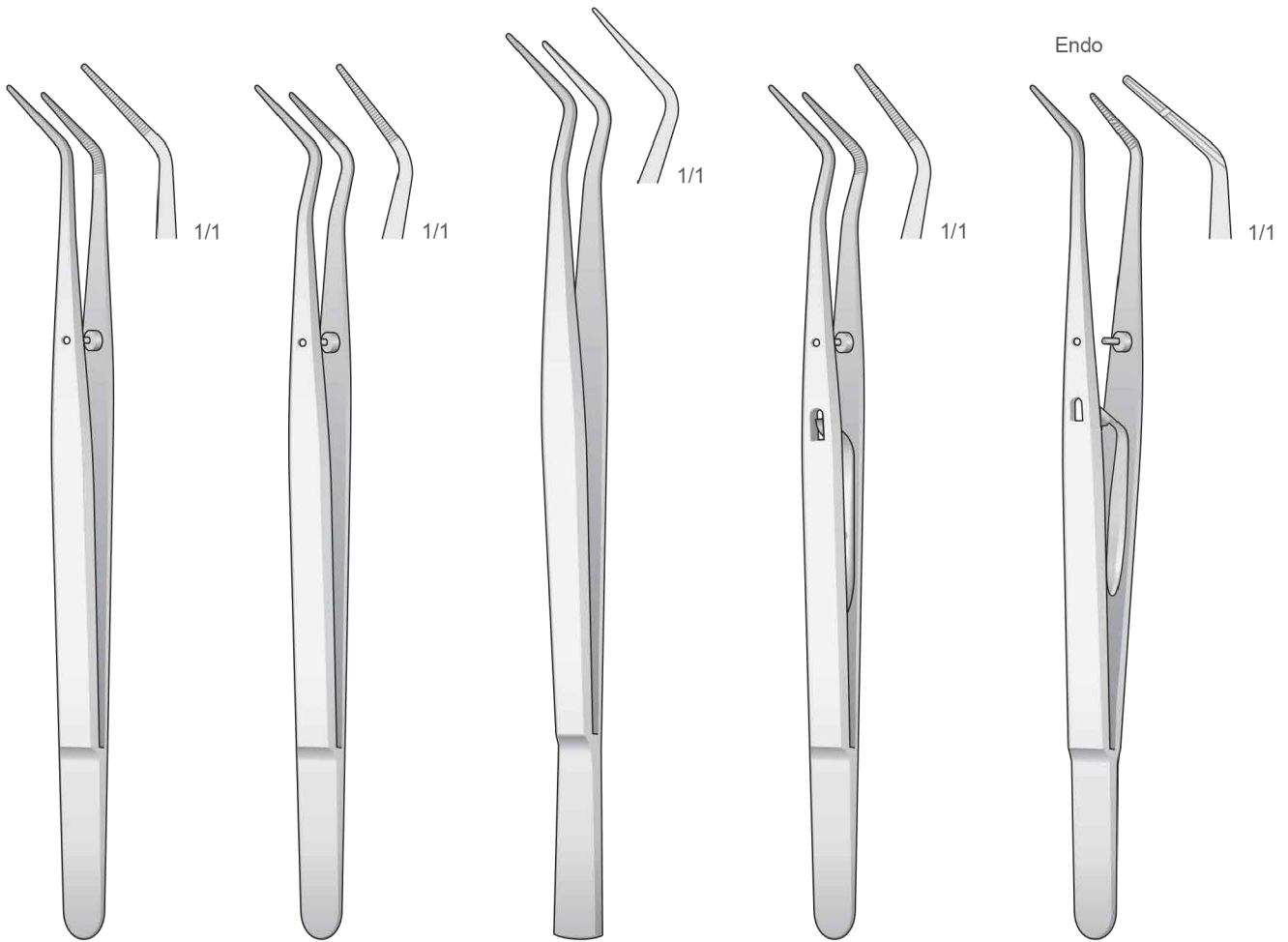
TM-FALGG  
160 mm

TM-COLLEGE-S  
150 mm

TM-DA-04  
150 mm

TM-DA-05  
150 mm

Zahnpinzetten  
Cotton and Dressing Pliers  
Pinzette per medicazione  
Pinzas para vendajes  
Précelles pour cotton



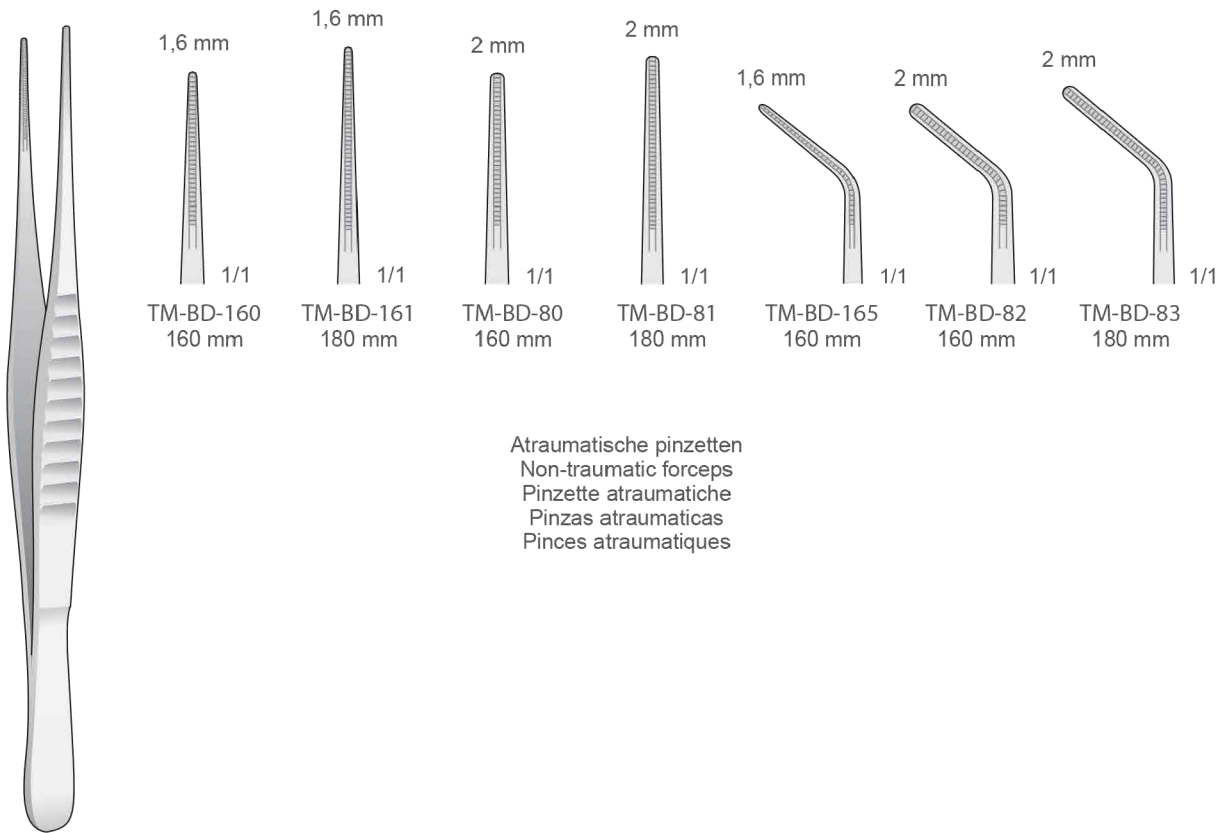
TM-COLLEGE  
TM-BD-01 Fig.17  
150 mm

TM-MERIAM  
TM-BD-02 Fig.18  
150 mm

CAULK  
TM-BD-11  
160 mm

LOCKING  
TM-BD-03 Fig.18L  
150 mm

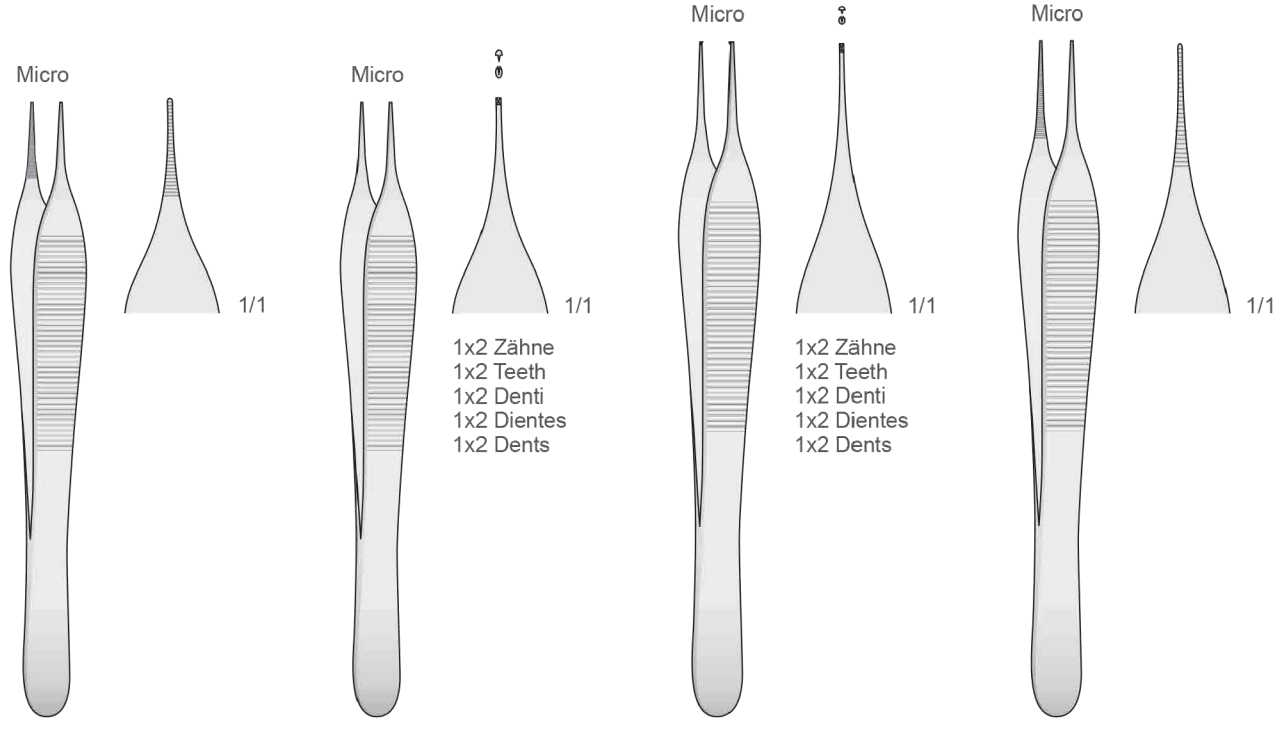
Endo  
TM-DA-09  
150 mm



1,6 mm 1,6 mm 2 mm 2 mm 1,6 mm 2 mm 2 mm  
1/1 1/1 1/1 1/1 1/1 1/1 1/1  
TM-BD-160 160 mm TM-BD-161 180 mm TM-BD-80 160 mm TM-BD-81 180 mm TM-BD-165 160 mm TM-BD-82 160 mm TM-BD-83 180 mm

Atraumatische pinzetten  
Non-traumatic forceps  
Pinzette atraumatiche  
Pinzas atraumaticas  
Pincas atraumatiques

DE BAKEY  
TM-BD-80/TM-BD-165



Micro Micro Micro Micro  
1/1 1/1 1/1 1/1

1x2 Zähne  
1x2 Teeth  
1x2 Denti  
1x2 Dientes  
1x2 Dents

1x2 Zähne  
1x2 Teeth  
1x2 Denti  
1x2 Dientes  
1x2 Dents

ADSON  
TM-BD-71  
120 mm

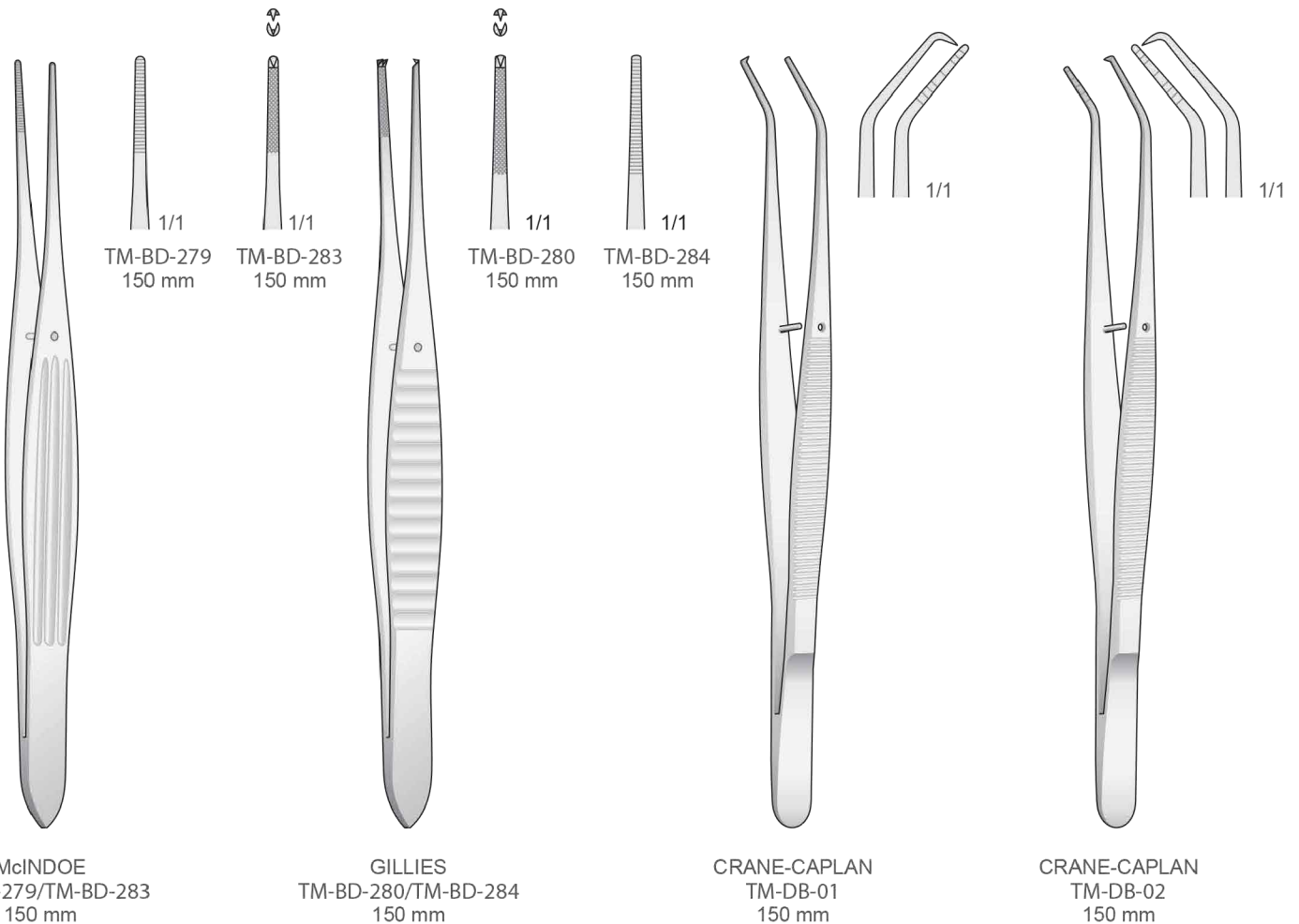
ADSON  
TM-BD-73  
120 mm

ADSON  
TM-BD-177  
150 mm

ADSON  
TM-BD-178  
150 mm

Chirurgische Pinzetten  
Tissue Forceps  
Pinzette chirurgiche  
Pinzas quirùrgicas  
Pinces chirurgicales

Taschenmarkierungspinzetten  
Pocket markers  
Pinzette segnatasche  
Pinzas para marcar el sulco periodontal  
Pinces à marquer la poche





GRAEFE  
TM-BD-04/TM-BD-96  
100 mm



1/1  
TM-BD-04



1/1  
TM-BD-96



1/1  
TM-BD-07



GRAEFE  
TM-BD-194/TM-BD-196  
100 mm



1/1  
TM-BD-194



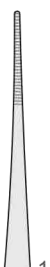
1/1  
TM-BD-195



1/1  
TM-BD-196



TM-BD-32/TM-BD-33  
100 mm



1/1  
TM-BD-32



1/1  
TM-BD-33



TM-BD-35/TM-BD-36  
100 mm



1/1  
TM-BD-35



1/1  
TM-BD-36



PERRY  
TM-BD-05  
125 mm



1/1



TM-BD-06  
125 mm

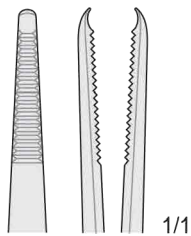


1/1

Anatomische Pinzetten  
Dressing Forceps  
Pinzette anatomiche  
Pinzas de diseccion  
Pincas anatomiques



TM-BD-270  
130 mm



1/1



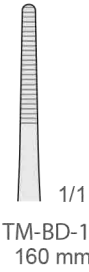
TM-BD-145  
130 mm



1/1

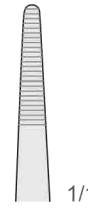


TM-BD-16/TM-BD-148  
160 mm



1/1

TM-BD-16  
160 mm

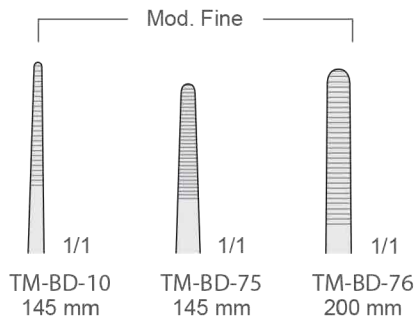


1/1

TM-BD-148  
160 mm



TM-BD-10/TM-BD-76



Mod. Fine

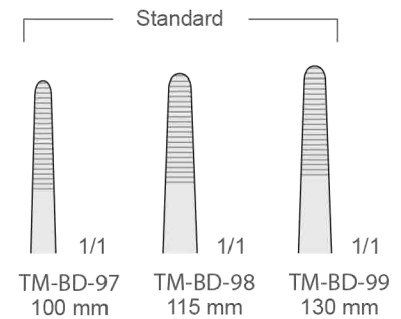
TM-BD-10  
145 mm

TM-BD-75  
145 mm

TM-BD-76  
200 mm



TM-BD-97/TM-BD-99

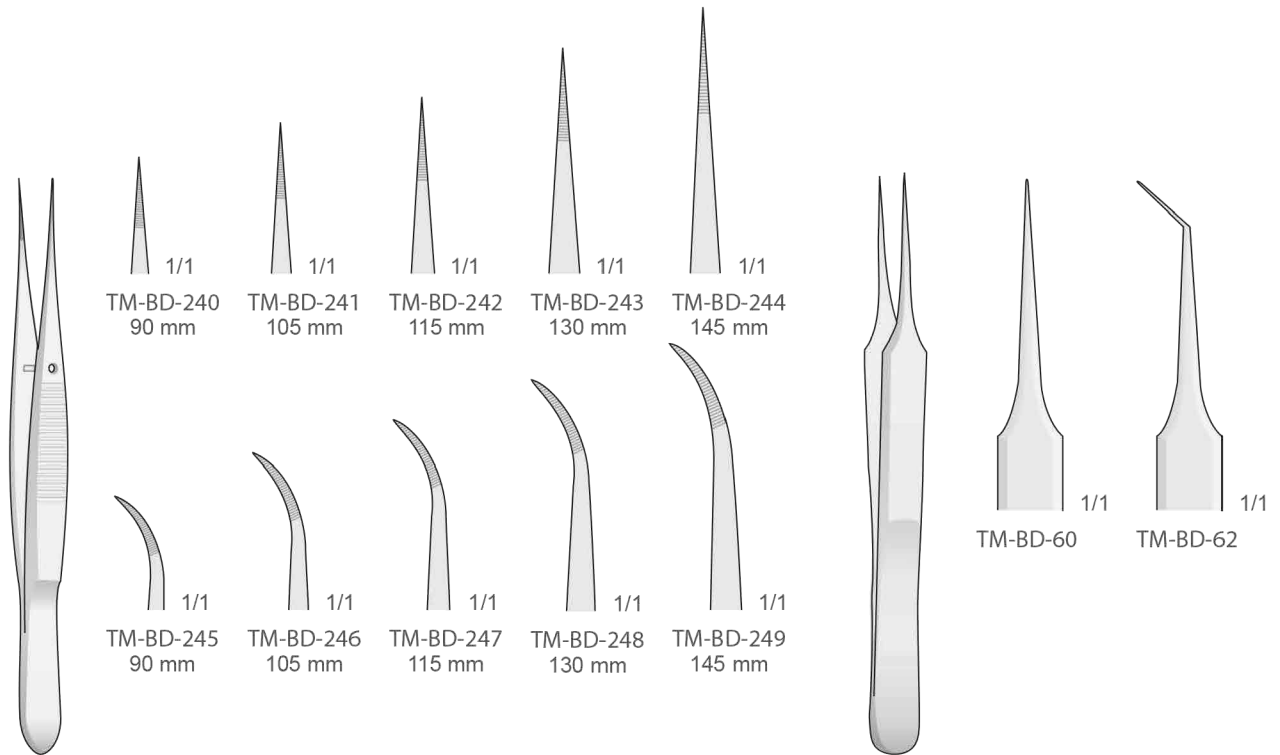


Standard

TM-BD-97  
100 mm

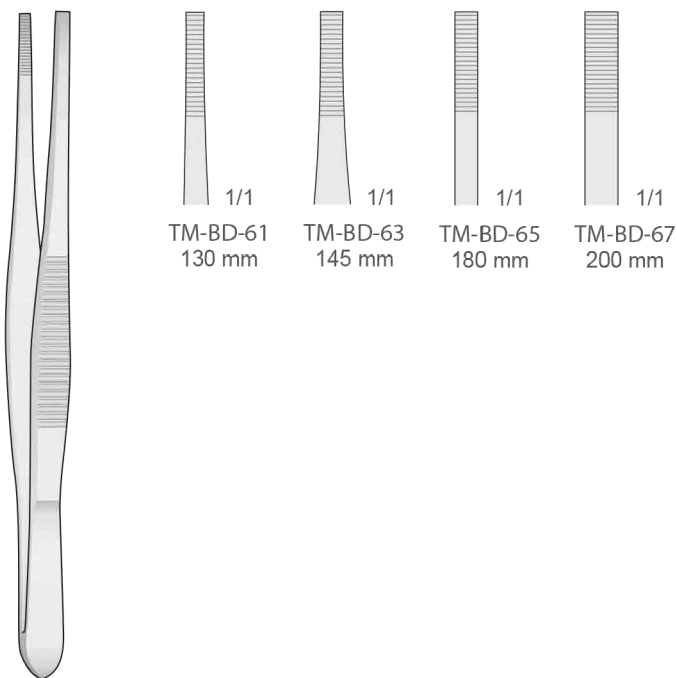
TM-BD-98  
115 mm

TM-BD-99  
130 mm



TM-BD-240/TM-BD-249

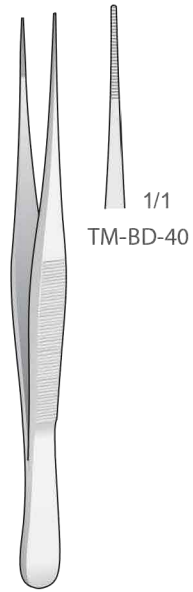
TM-BD-60/TM-BD-62  
110 mm



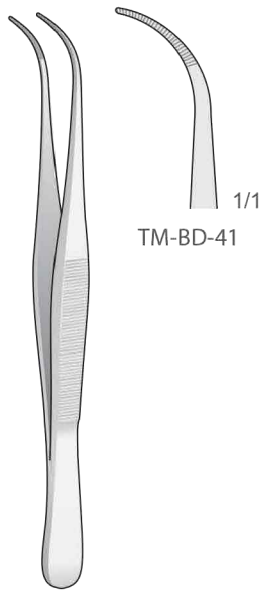
STILLE  
TM-BD-61/TM-BD-67

TM-BD-142/TM-BD-143

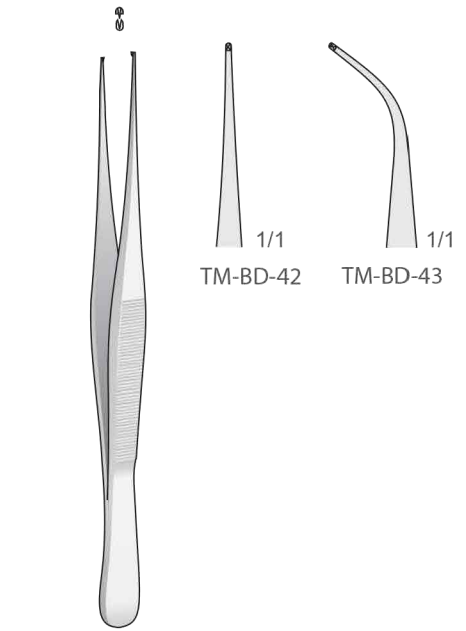
Chirurgische Pinzetten  
Tissue Forceps  
Pinzette chirurgische  
Pinzas quirùrgicas  
Pincas quirurgicales



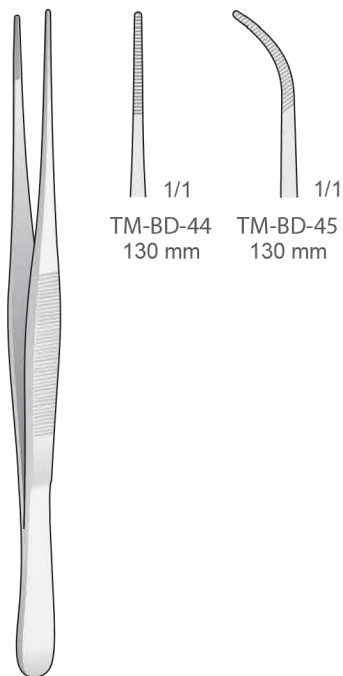
TM-BD-40  
110 mm



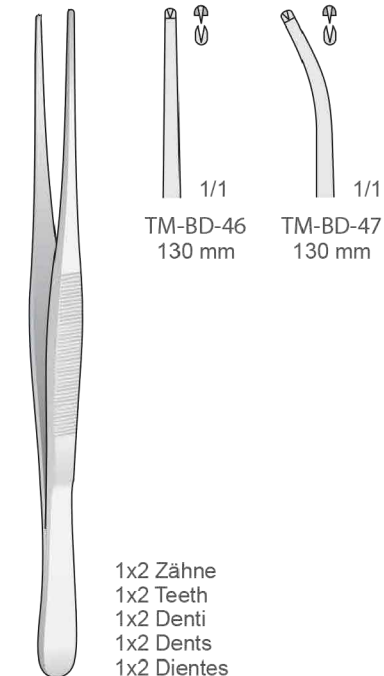
TM-BD-41  
110 mm



TM-BD-42/TM-BD-43  
110 mm

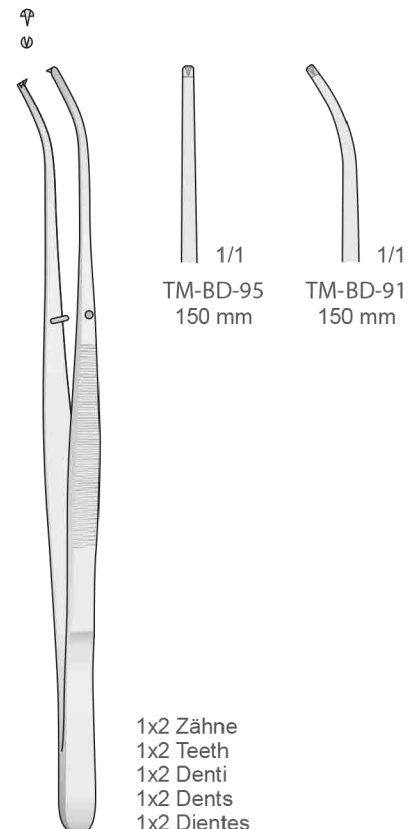


SEMKEN  
TM-BD-44/TM-BD-45  
130 mm



SEMKEN  
TM-BD-46/TM-BD-47  
130 mm

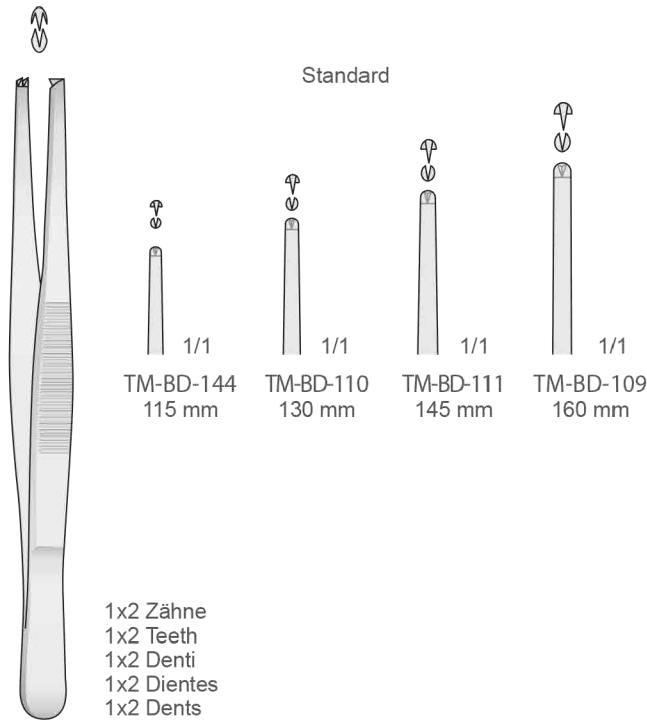
1x2 Zähne  
1x2 Teeth  
1x2 Denti  
1x2 Dents  
1x2 Dientes



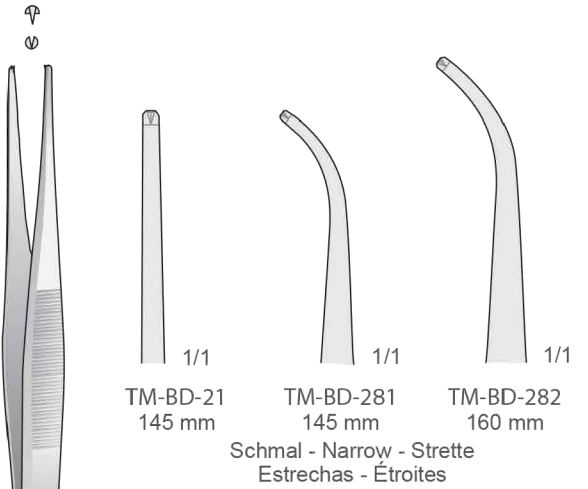
SEMKEN  
TM-BD-91/TM-BD-95  
150 mm

1x2 Zähne  
1x2 Teeth  
1x2 Denti  
1x2 Dents  
1x2 Dientes





TM-BD-109/TM-BD-144



TM-BD-21/TM-BD-282

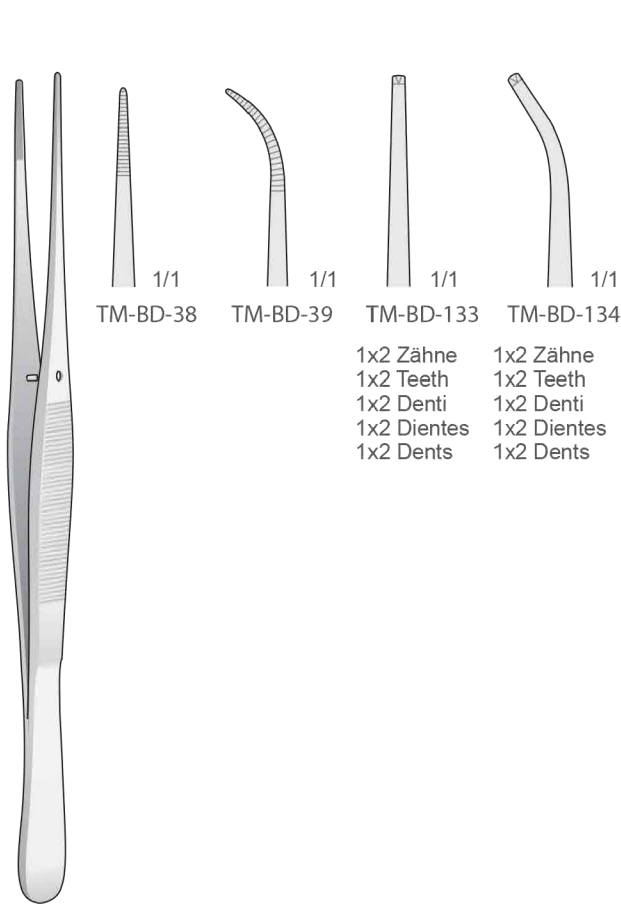
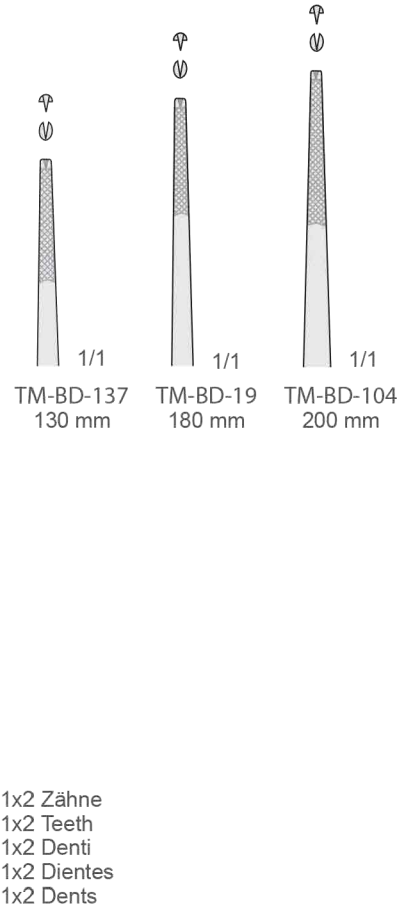
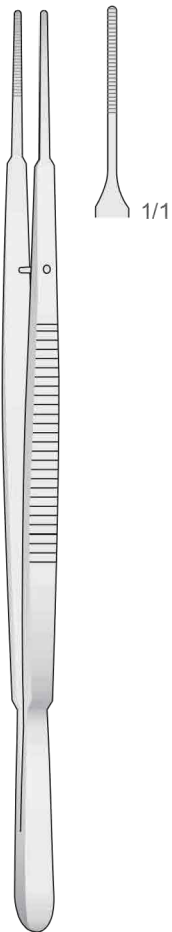


Fig.17  
TM-BD-38/TM-BD-134  
200 mm

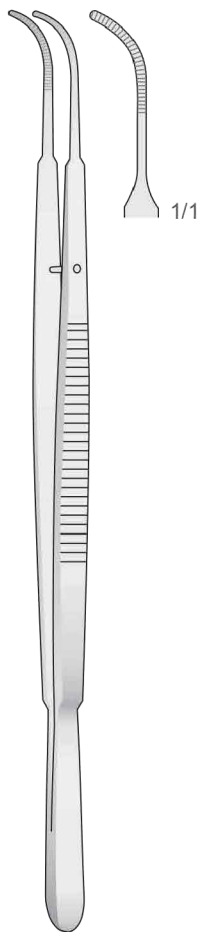


TM-BD-19/TM-BD-137

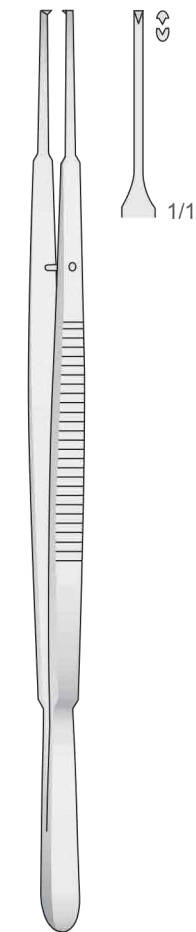
Chirurgische Pinzetten  
Tissue Forceps  
Pinzette chirurgiche  
Pinzas quirùrgicas  
Pincas quirurgicales



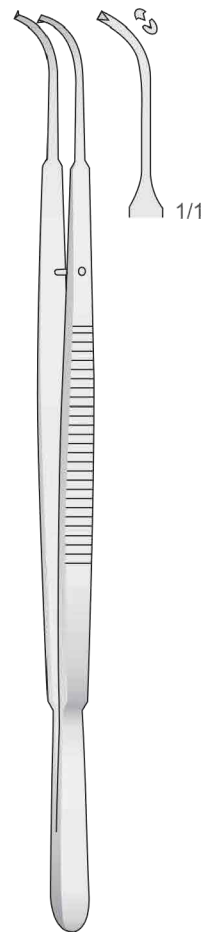
GERALD  
TM-MF-101  
180 mm



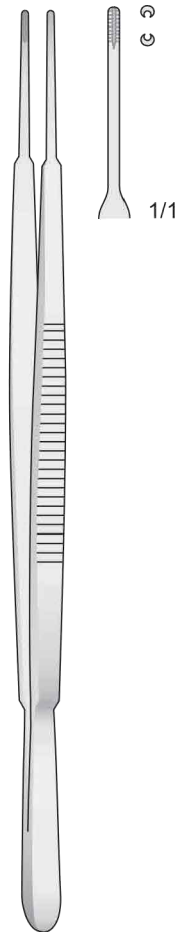
GERALD  
TM-MF-102  
180 mm



GERALD  
TM-MF-103  
180 mm



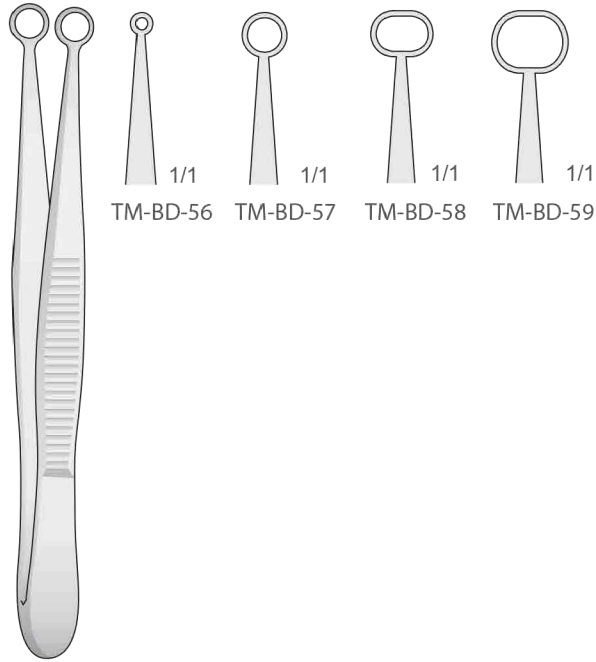
GERALD  
TM-MF-104  
180 mm



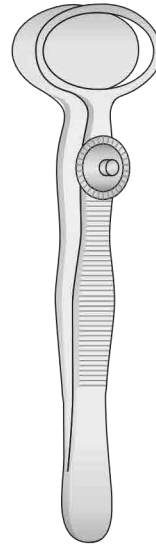
GERALD-BROWN  
TM-MF-105  
180 mm

Chirurgische Pinzetten  
Tissue Forceps  
Pinzette chirurgiche  
Pinzas quirúrgicas  
Pincas quirúrgicas

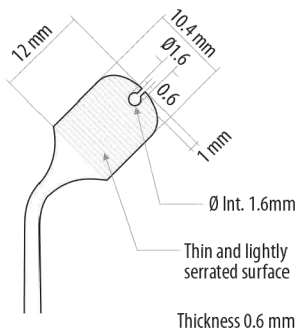
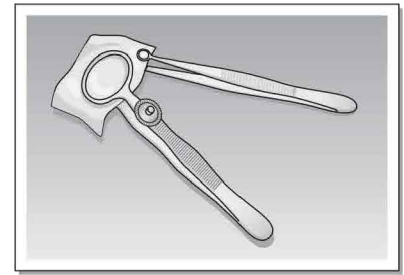
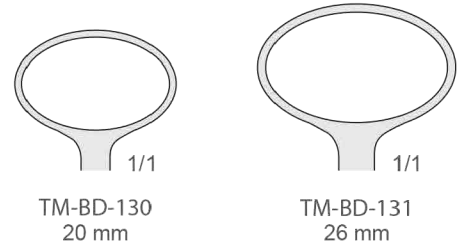
Membrane Forceps  
with delicate Ring tip



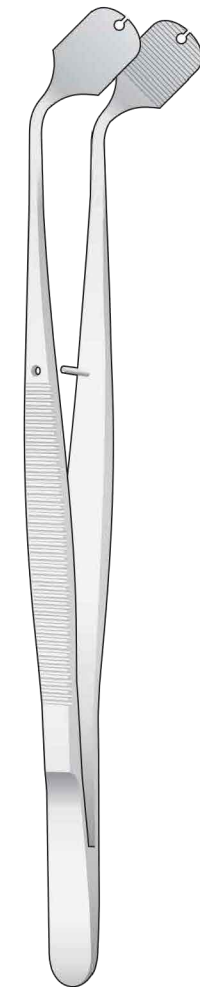
TM-BD-56/TM-BD-59  
100 mm



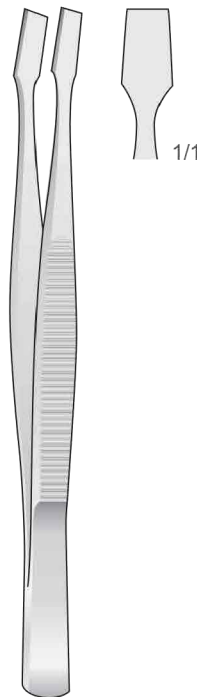
DESMARRES  
TM-BD-130/TM-BD-131  
90 mm



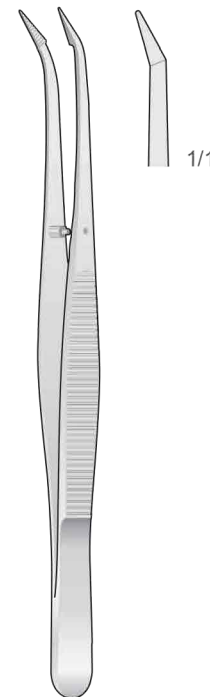
Pinzetten zum Halten Membranen  
Membrane Holding forceps  
Pinza per fissaggio membrane  
Pinza para sostener membranas  
Pince pour le maintien membranes



TM-TASO-9  
150 mm



KÜHNE  
TM-ES-44  
105 mm

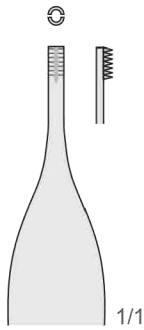


BARRAQUER  
TM-ES-65  
105 mm

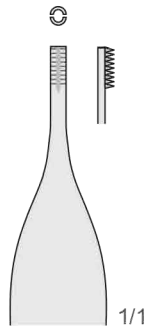
Chirurgische Pinzetten  
Tissue Forceps  
Pinzette chirurgische  
Pinzas quirúrgicas  
Pincas quirúrgicas



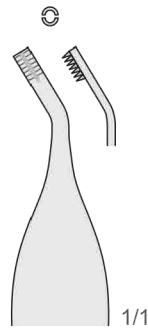
ADSON-BROWN  
TM-BD-92/TM-BD-141  
120 mm



TM-BD-92  
120 mm  
6x6 Zähne  
6x6 Teeth  
6x6 Denti  
6x6 Dientes  
6x6 Dents



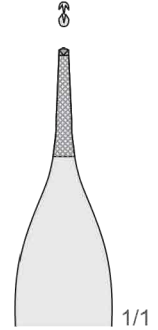
TM-BD-141  
120 mm  
9x9 Zähne  
9x9 Teeth  
9x9 Denti  
9x9 Dientes  
9x9 Dents



TM-BD-93  
120 mm  
6x6 Zähne  
6x6 Teeth  
6x6 Denti  
6x6 Dientes  
6x6 Dents



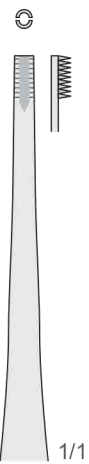
ADSON  
TM-BD-90  
120 mm



TM-BD-90  
120 mm



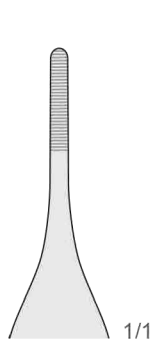
BROWN  
TM-BD-94  
150 mm



8x8 Zähne  
8x8 Teeth  
8x8 Denti  
8x8 Dientes  
8x8 Dents



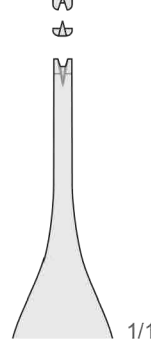
ADSON  
TM-BD-380  
150 mm



1/1



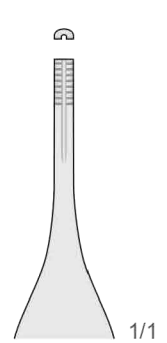
ADSON  
TM-BD-381  
150 mm



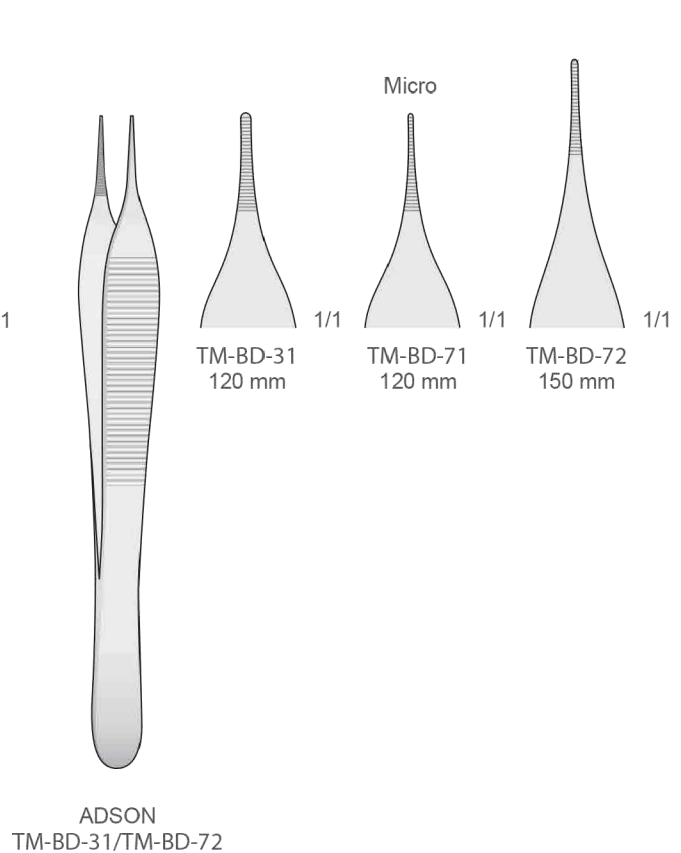
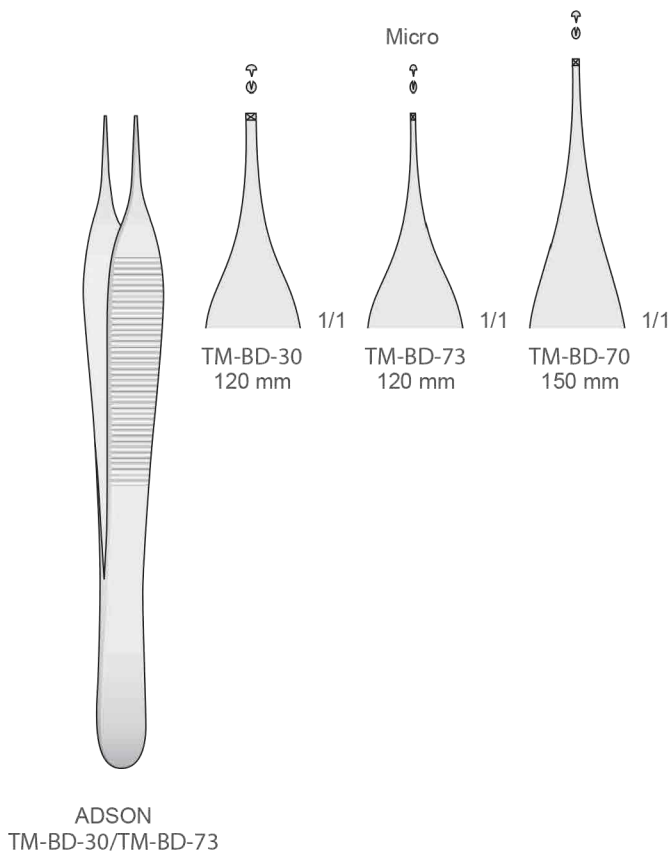
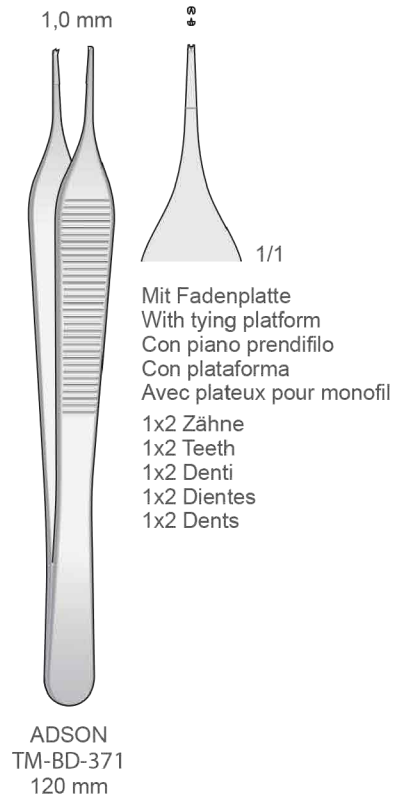
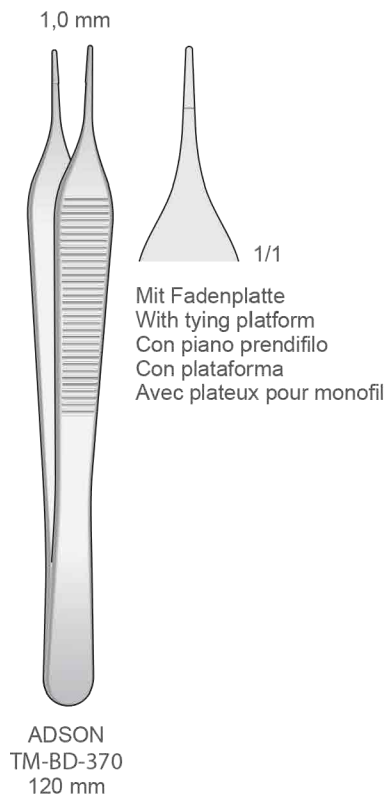
1x2 Zähne  
1x2 Teeth  
1x2 Denti  
1x2 Dientes  
1x2 Dents



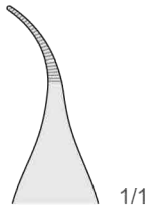
ADSON-BROWN  
TM-BD-382  
150 mm



9x9 Zähne  
9x9 Teeth  
9x9 Denti  
9x9 Dientes  
9x9 Dents



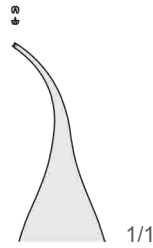
Chirurgische Pinzetten - Anatomische Pinzetten  
Tissue Forceps - Dressing forceps  
Pinzette chirurgiche - Pinzette anatomiche  
Pinzas quirùrgicas - Pinzas de diseccion  
Pincas quirurgicales - Pincas anatomiques



Extra fein  
Extra fine  
Extra fine  
Extra finas  
Extra fins

Gebogen  
Curved  
Curva  
Curvas  
Courbé

MICRO-ADSON  
TM-BD-372  
120 mm

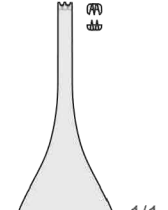


Extra fein  
Extra fine  
Extra fine  
Extra finas  
Extra fins

Gebogen  
Curved  
Curva  
Curvas  
Courbé

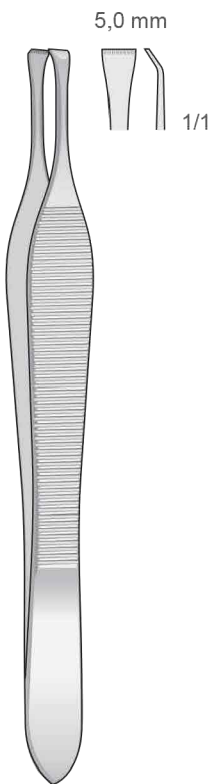
1x2 Zähne  
1x2 Teeth  
1x2 Denti  
1x2 Dientes  
1x2 Dents

MICRO-ADSON  
TM-BD-373  
120 mm

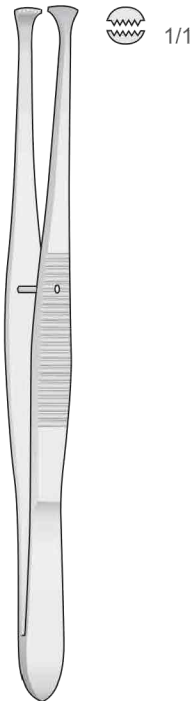


2x3 Zähne  
2x3 Teeth  
2x3 Denti  
2x3 Dientes  
2x3 Dents

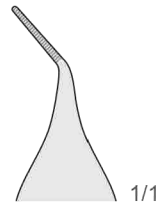
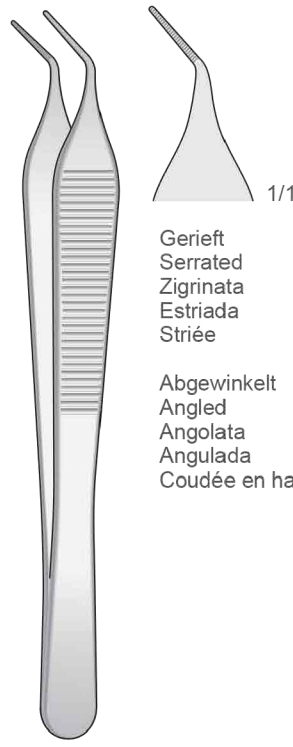
ADSON  
TM-BD-377  
120 mm



BEASLEY-BABCOCK  
TM-BD-51  
120 mm



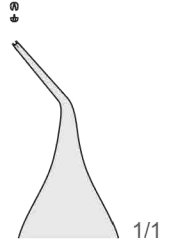
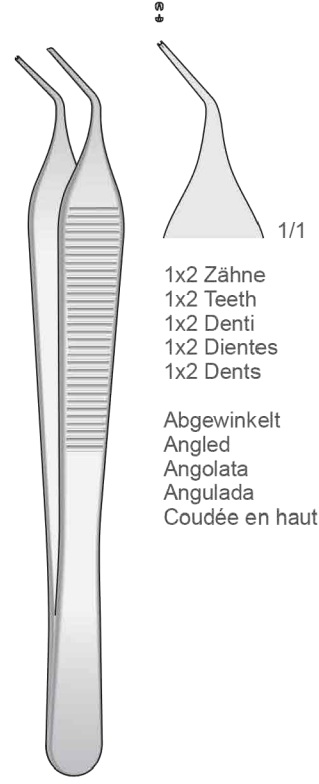
GRAEFE  
TM-BD-135  
110 mm



Gerieft  
Serrated  
Zigrinata  
Estriada  
Striée

Abgewinkelt  
Angled  
Angolata  
Angulada  
Coudée en haut

ADSON  
TM-BD-378  
120 mm

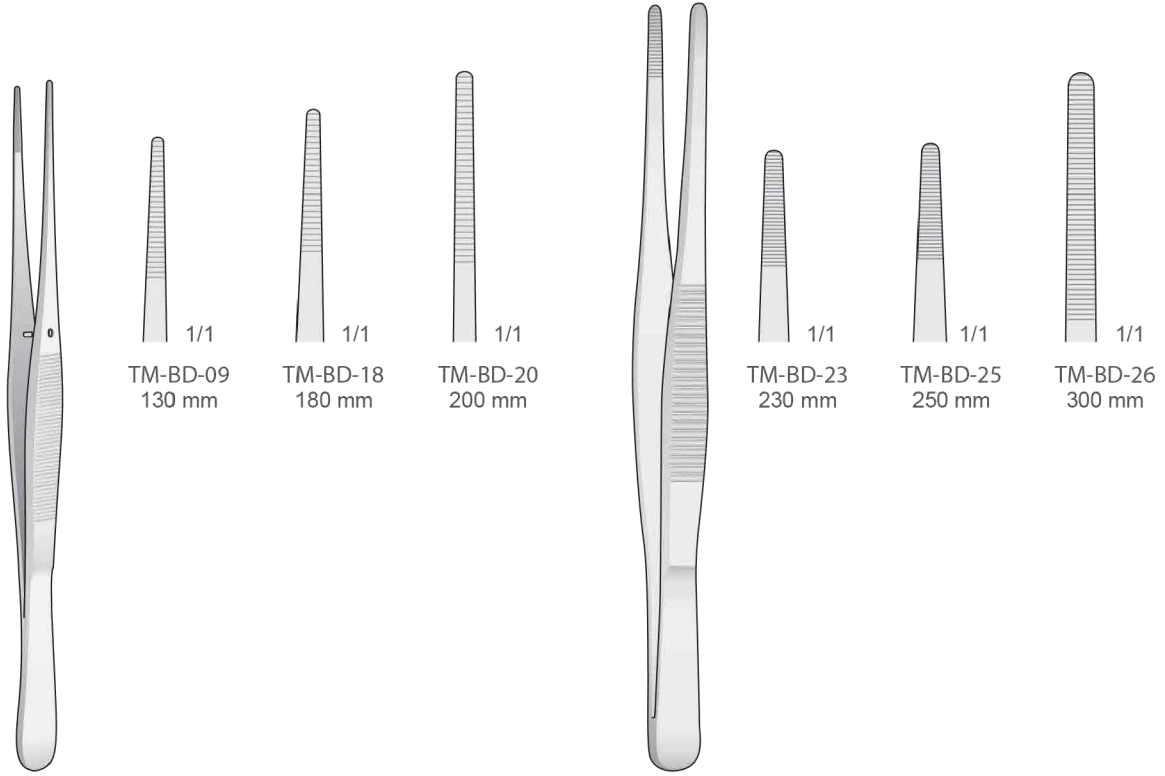


1x2 Zähne  
1x2 Teeth  
1x2 Denti  
1x2 Dientes  
1x2 Dents

Abgewinkelt  
Angled  
Angolata  
Angulada  
Coudée en haut

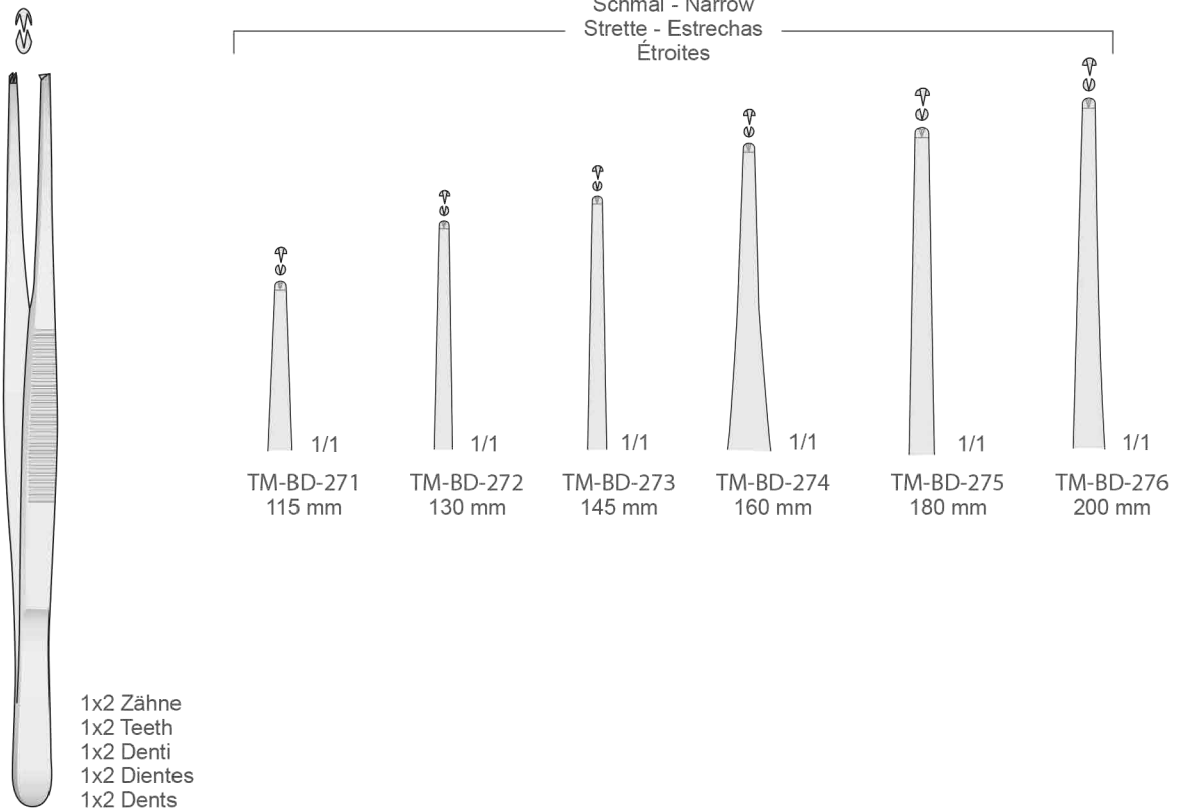
ADSON  
TM-BD-379  
120 mm

Chirurgische Pinzetten - Anatomische Pinzetten  
Tissue Forceps - Dressing forceps  
Pinzette chirurgiche - Pinzette anatomiche  
Pinzas quirùrgicas - Pinzas de diseccion  
Pinces chirurgicales - Pinces anatomiques



TM-BD-09/TM-BD-20

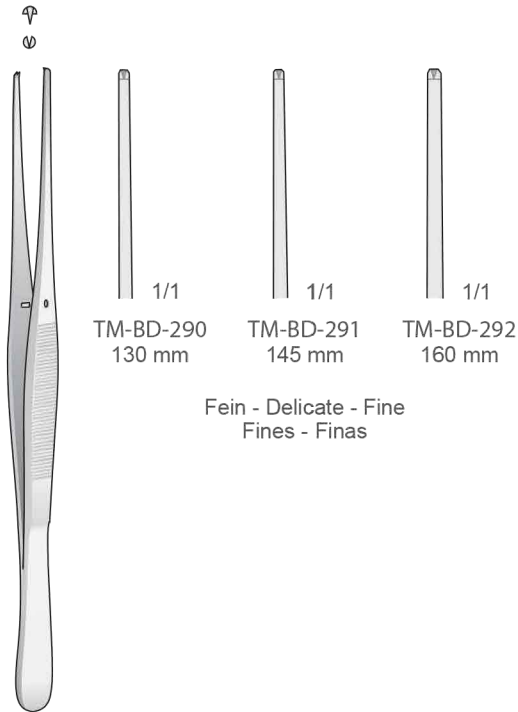
TM-BD-23/TM-BD-26



TM-BD-271/TM-BD-276

1x2 Zähne  
1x2 Teeth  
1x2 Denti  
1x2 Dientes  
1x2 Dents

Chirurgische Pinzetten  
Tissue Forceps  
Pinzette chirurgiche  
Pinzas chirùrgicas  
Pincas chirurgicales



TM-BD-290/TM-BD-292

1/1  
TM-BD-290  
130 mm

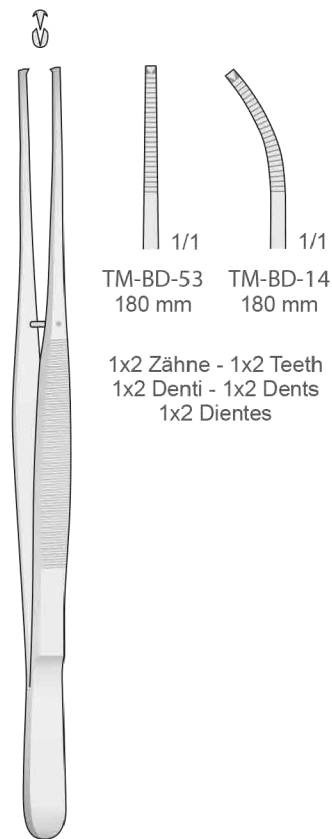
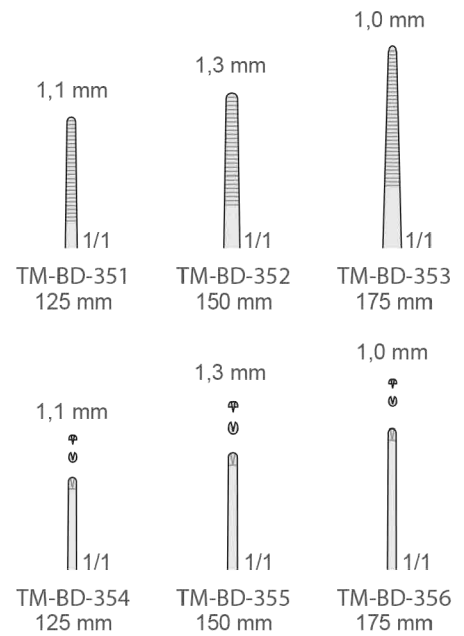
1/1  
TM-BD-291  
145 mm

1/1  
TM-BD-292  
160 mm

Fein - Delicate - Fine  
Fines - Finas



BD-351/B D-356

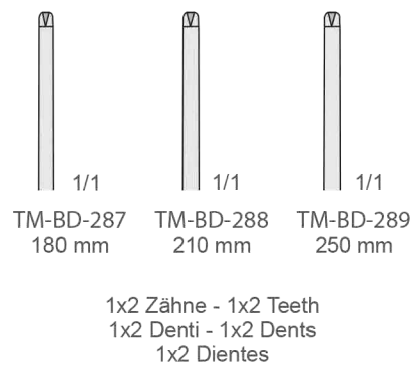


POTTS-SMITH  
TM-BD-14/TM-BD-53  
180 mm

1x2 Zähne - 1x2 Teeth  
1x2 Denti - 1x2 Dents  
1x2 Dientes



POTTS-SMITH  
TM-BD-287/TM-BD-289

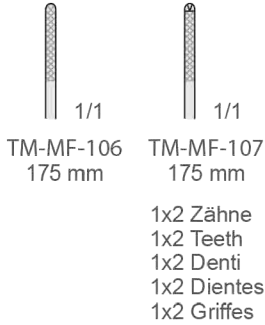


1x2 Zähne - 1x2 Teeth  
1x2 Denti - 1x2 Dents  
1x2 Dientes



Chirurgische Pinzetten, Atraumatische Pinzetten  
Tissue Forceps, Non-traumatic Forceps  
Pinzette chirurgiche, Pinzette atraumatiche  
Pinzas quirùrgicas, Pinzas atraumàticas  
Pincas chirurgicales, Pincas atraumaticas

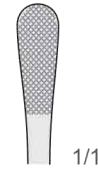
TC



**GERALD**  
TM-MF-106/TM-MF-107  
175 mm

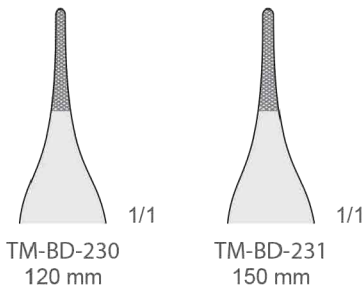
**Tungsten-Carbide Inserts**  
Mit Hartmetalleinsätzen  
Plaquettes en carbure de tungstène  
Plaquetas de carburo de tungsteno  
Inserti in carburo di tungsteno

TC



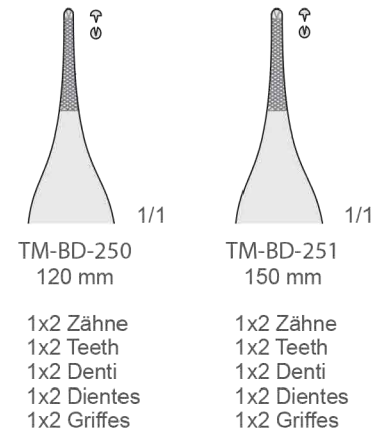
**WANGENSTEEN**  
TM-BD-232  
150 mm

TC



**ADSON**  
TM-BD-230/TM-BD-231

TC



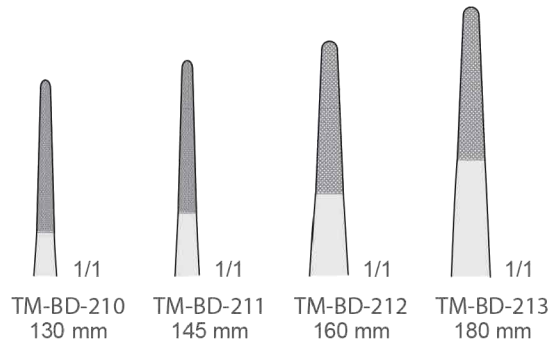
**ADSON**  
TM-BD-250/TM-BD-251

Chirurgische Pinzetten, Atraumatische Pinzetten  
Tissue Forceps, Non-traumatic Forceps  
Pinzette chirurgiche, Pinzette atraumatiche  
Pinzas quirùrgicas, Pinzas atraumáticas  
Pincas quirurgicales, Pincas atraumaticas

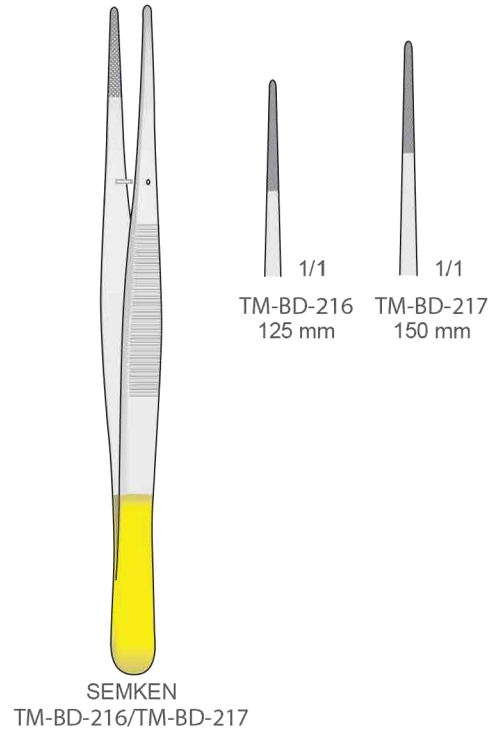


TM-BD-210/TM-BD-213

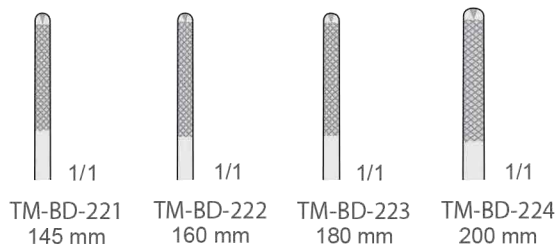
Standard



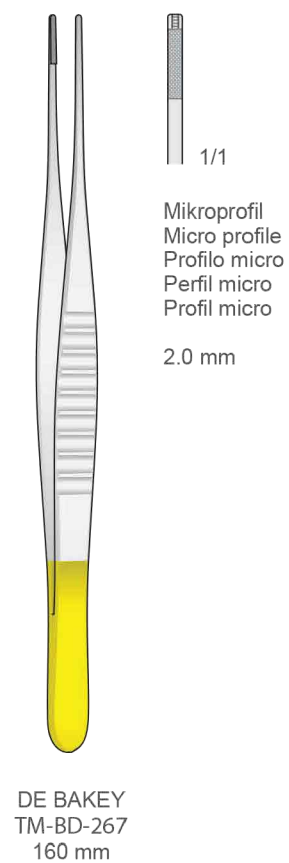
TC



TM-BD-221/TM-BD-224

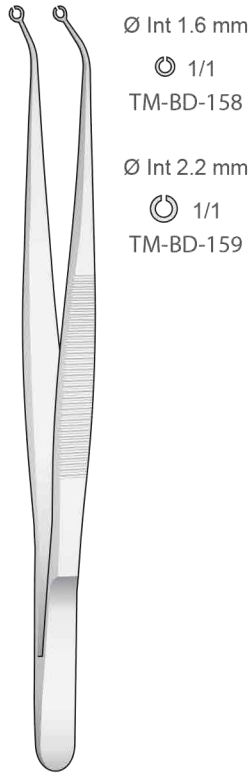


TC

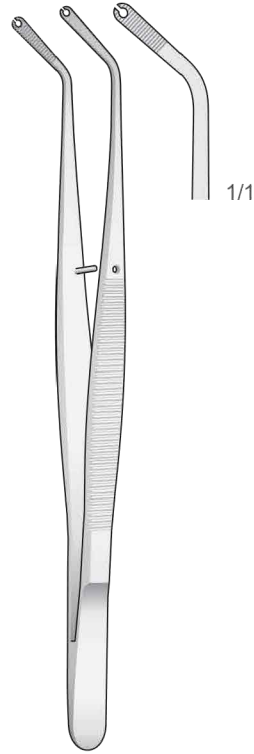


Naht-und Membranpinzette - Suture and membrane Forceps  
Pinzette per suture e membrane - Pinzas para suturas y membranas  
Pincettes à suture et à membrane

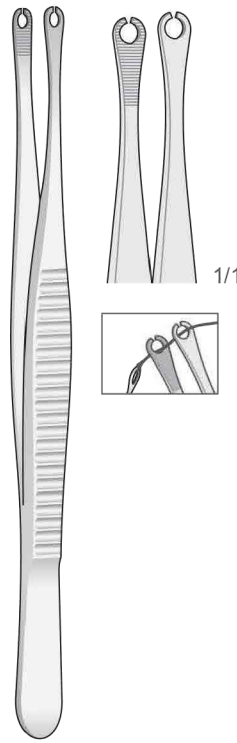
Pinzette  
Forceps  
Pinzette  
Pinzas  
Pincés



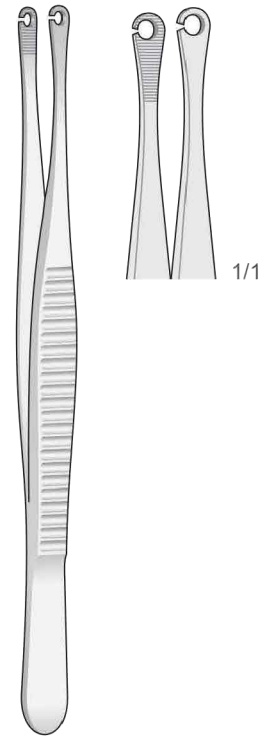
TM-BD-158/TM-BD-159  
160 mm



CORN  
TM-DA-07  
150 mm

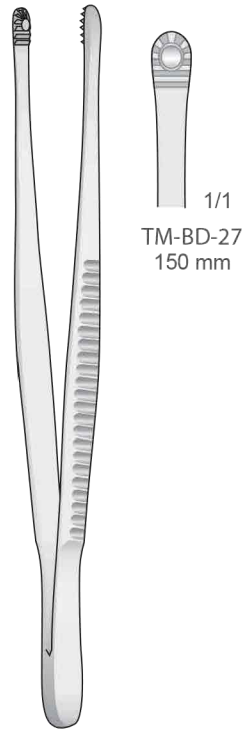


TM-DA-06  
150 mm

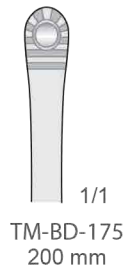


TM-DA-08  
150 mm

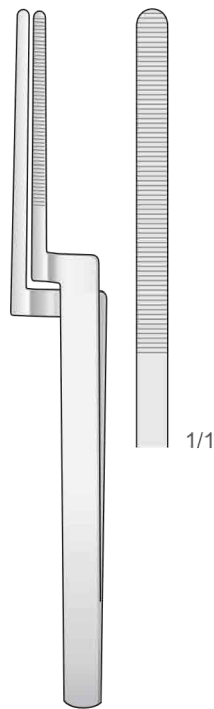
Artikulationspapier-Pinzetten - Articulating Paper Forceps  
Pinza per carta articolazione - Pinzas para papel de articular  
Pince pour papier à articuler



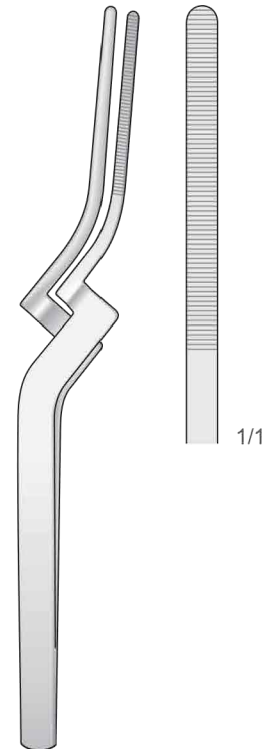
RUSSIAN  
TM-BD-27/TM-BD-175



TM-BD-175  
200 mm



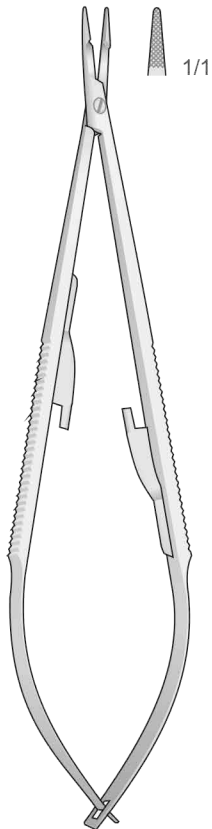
MILLER  
TM-DR-78  
145 mm



MILLER  
TM-DR-80  
160 mm

Nadelhalter  
Needle Holders  
Port'aghi  
Portaagujas  
Porte aiguilles

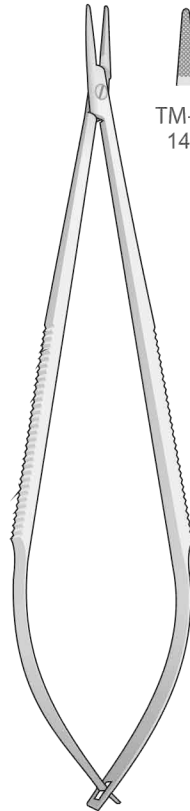
Mit Scheren  
With Scissor  
Con forbice  
Con tijeras  
Avec ciseaux



TM-FD-26  
140 mm

1/1  
TM-FD-14  
140 mm

1/1  
TM-FD-16  
140 mm

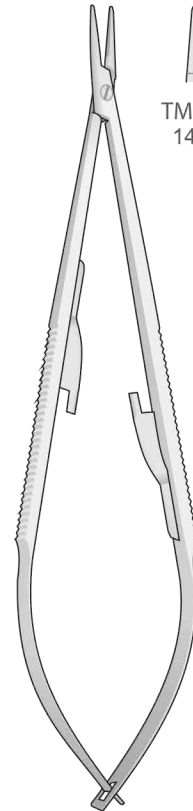


TM-FD-14/TM-FD-16  
140 mm

Glattes Maul  
Smooth Jaw  
Morso liscio  
Mandibula lisa  
Mors lisse

1/1  
TM-FD-17  
140 mm

1/1  
TM-FD-19  
140 mm

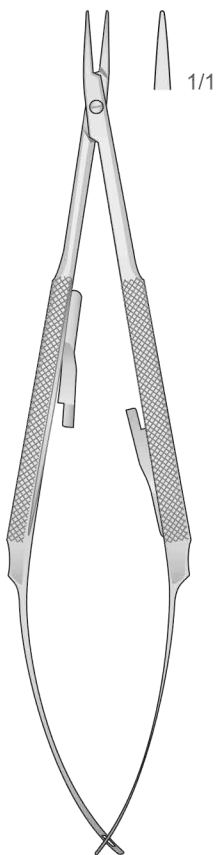


CASTROVIEJO  
TM-FD-17/TM-FD-19  
140 mm

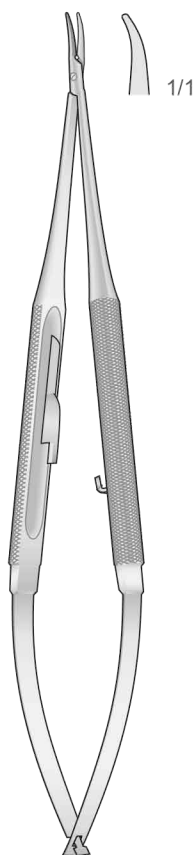
Mit Locking-System  
With Locking System (stop)  
Con sistema di bloccaggio  
Con sistema de bloqueo  
Avec système de verrouillage

Glattes Maul  
Smooth Jaw  
Morso liscio  
Mandíbula lisa  
Mors lisse

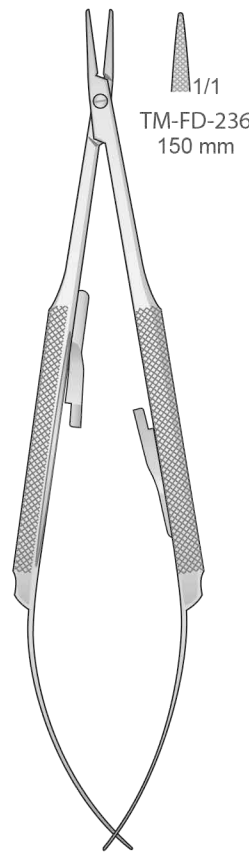
Feingerieftes Maul  
Fine serrated jaws  
Morso zigrinato fine  
Mandíbula estriada fina  
Mors strié fin



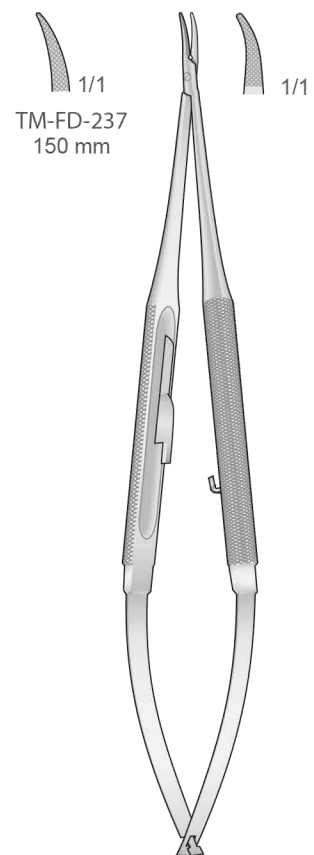
BARRAQUER  
TM-FD-216  
150 mm



BARRAQUER  
TM-FD-217  
150 mm



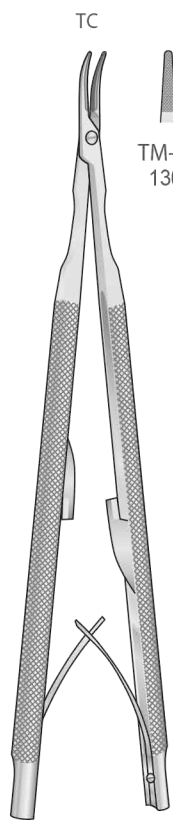
BARRAQUER  
TM-FD-236/TM-FD-237  
150 mm



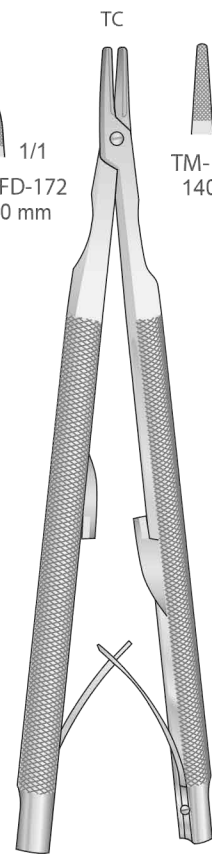
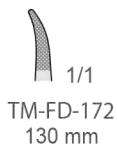
BARRAQUER  
TM-FD-24  
150 mm

Nadelhalter  
Needle Holders  
Port'aghi  
Portaagujas  
Porte aiguilles

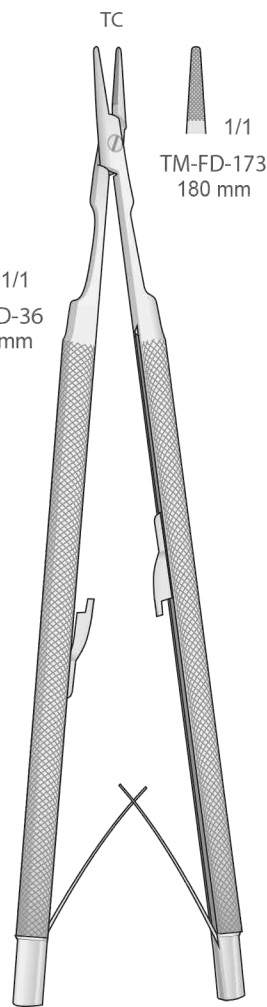
**Tungsten-Carbide Inserts**  
Mit Hartmetalleinsätzen  
Plaquettes en carbure de tungstène  
Plaquetas de carburo de tungsteno  
Inserti in carburo di tungsteno



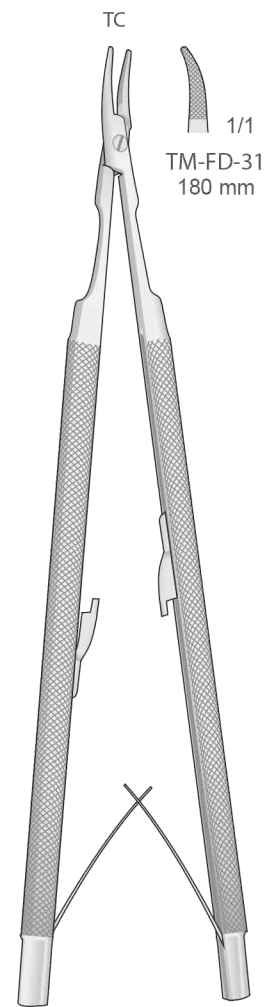
CASTROVIEJO  
TM-FD-34/TM-FD-172  
130 mm



CASTROVIEJO  
TM-FD-36/TM-FD-37  
140 mm



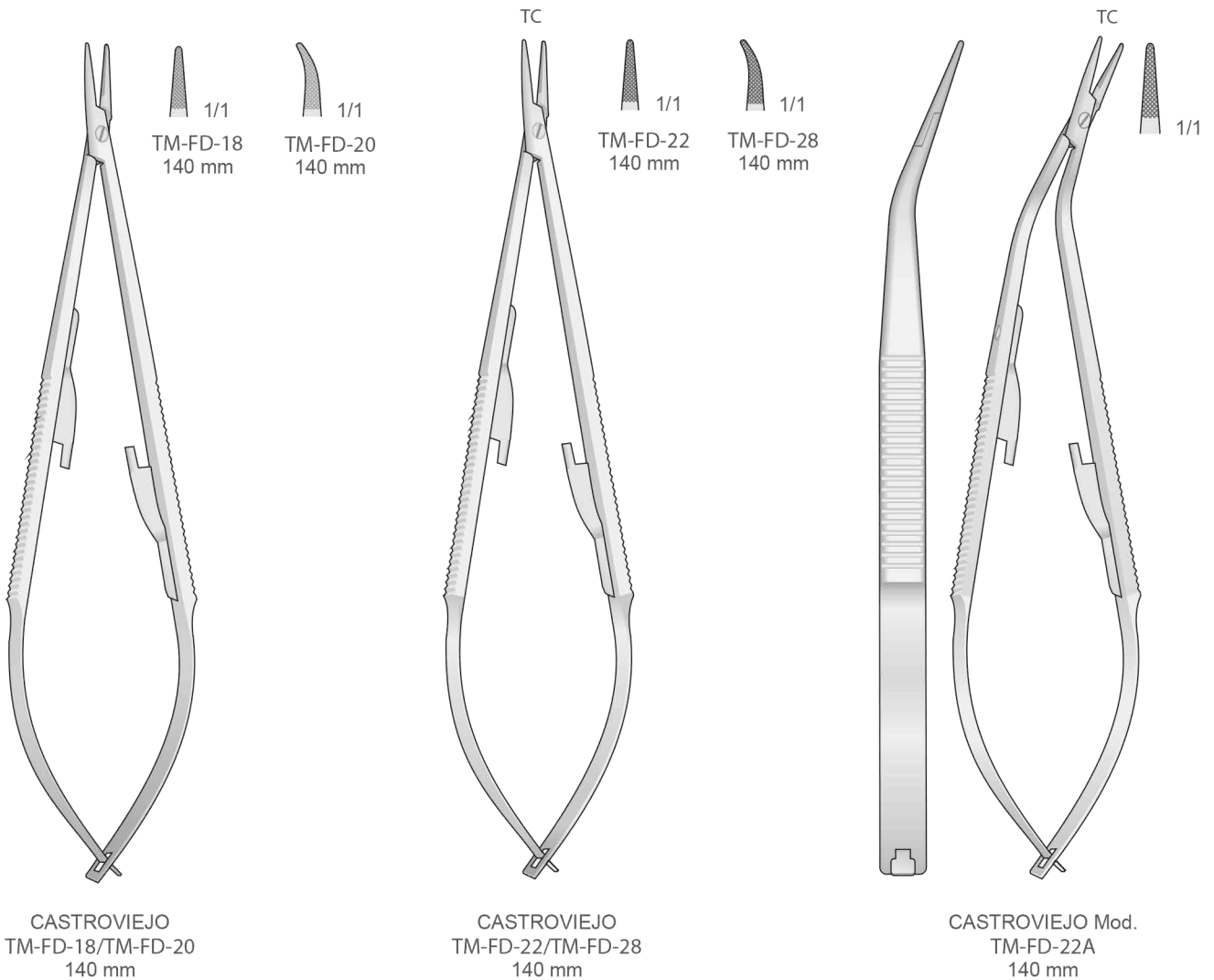
CASTROVIEJO  
TM-FD-173  
180 mm



CASTROVIEJO  
TM-FD-31  
180 mm

**Tungsten-Carbide Inserts**

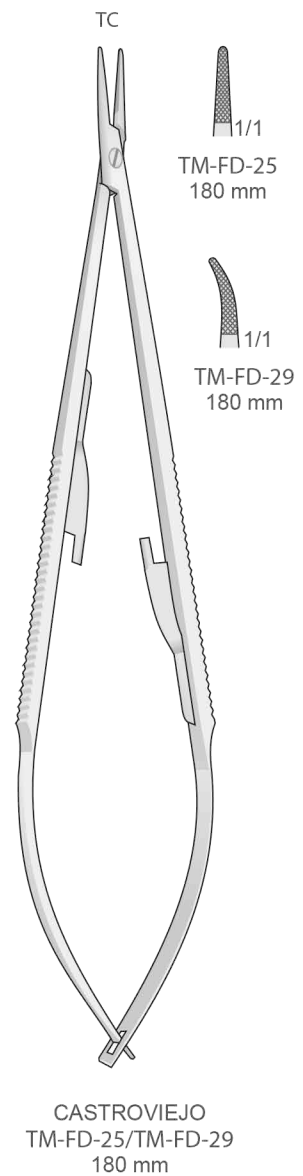
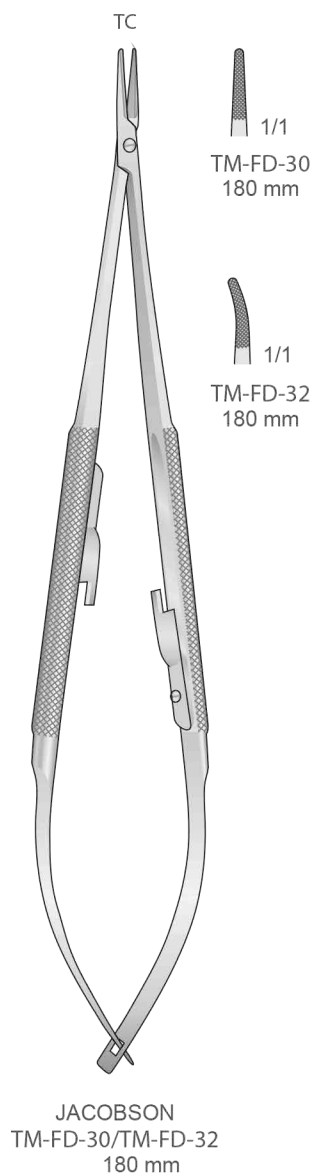
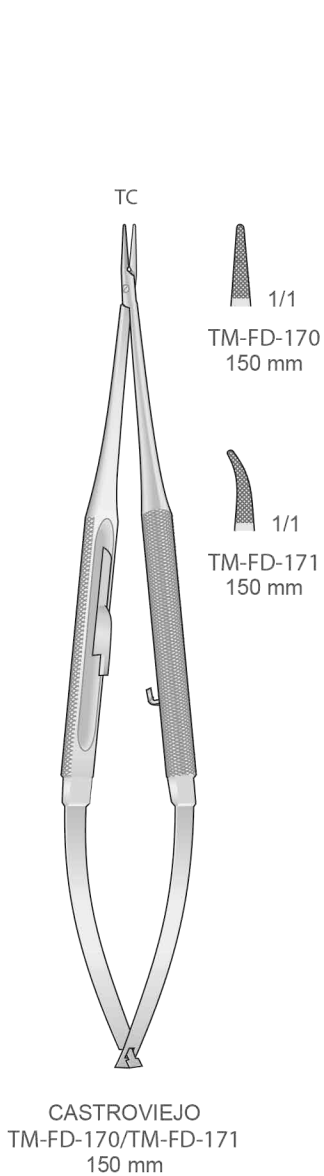
Mit Hartmetalleinsätzen  
Plaquettes en carbure de tungstène  
Plaquetas de carburo de tungsteno  
Inserti in carburo di tungsteno



Nadelhalter  
Needle Holders  
Port'aghi  
Portaagujas  
Porte aiguilles

**Tungsten-Carbide Inserts**

Mit Hartmetalleinsätzen  
Plaquettes en carbure de tungstène  
Plaquetas de carburo de tungsteno  
Inserti in carburo di tungsteno

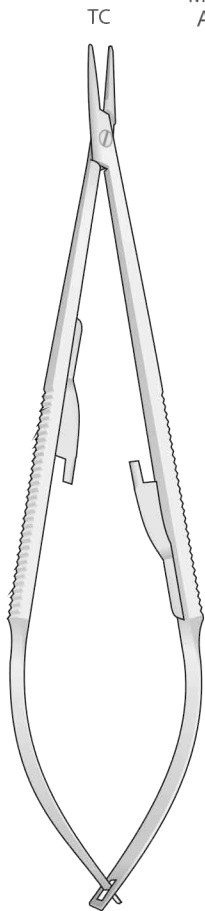




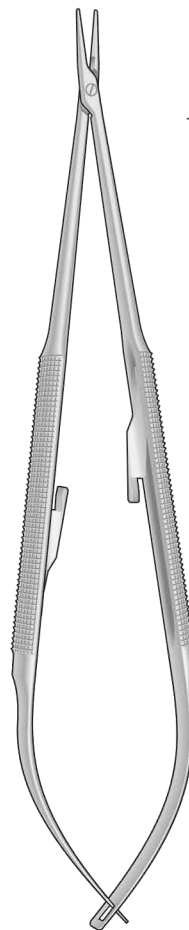
**Tungsten-Carbide Inserts**

Mit Hartmetalleinsätzen  
Plaquettes en carbure de tungstène  
Plaquetas de carburo de tungsteno  
Inserti in carburo di tungsteno

Glattes Maul  
Smooth jaws  
Con morso liscio  
Mandibula lisa  
A' mors lisse



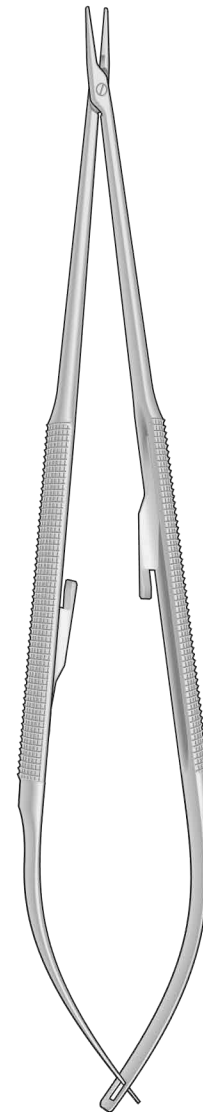
CASTROVIEJO  
TM-FD-21/TM-FD-23  
140 mm



TM-FD-599/TM-FD-600  
150 mm

**Diamond Tip**

Diamantiert  
Punta diamantata  
Punta de diamante  
Pointe de diamant



TM-FD-601/TM-FD-602  
180 mm

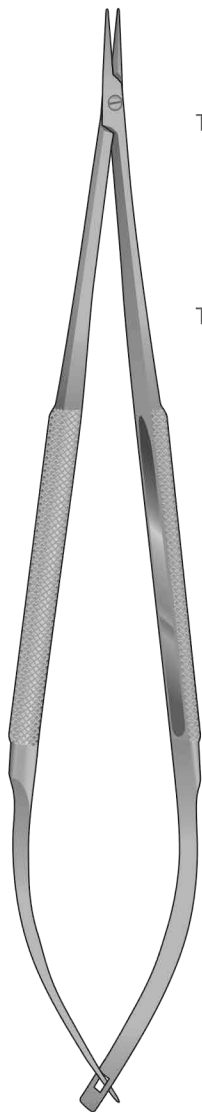
Mikro Nadelhalter - Mikro Scheren  
 Micro Needle Holders - Micro Scissors  
 Micro Port'aghi - Micro Forbici  
 Micro Portaagujas - Micro Tijeras  
 Micro Porte aiguilles - Micro Ciseaux

**Titanium**  
 Titan  
 Titane  
 Titanio  
 Titanio

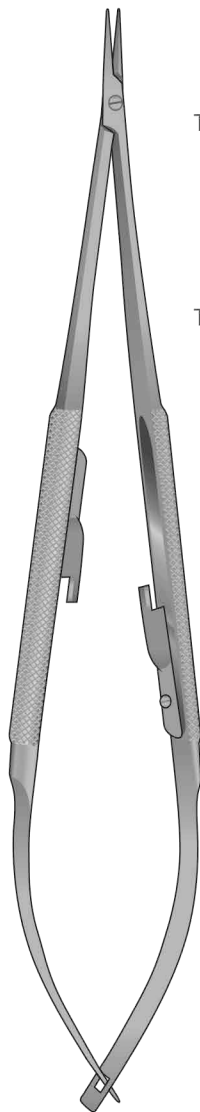
Rund-Griffe Ø 8 mm  
 Round handle Ø 8 mm  
 Manico rotondo Ø 8 mm  
 Mango redondo Ø 8 mm  
 Manche rond Ø 8 mm

Mikro Nadelhalter  
 Micro Needle Holders  
 Micro port'aghi  
 Micro portaagujas  
 Micro porte aiguilles

Mikro Scheren  
 Micro Scissors  
 Micro forbici  
 Micro tijeras  
 Micro ciseaux

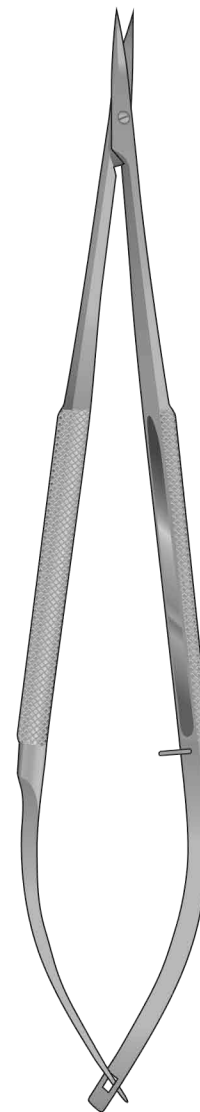


TM-FD-562T/TM-FD-563T  
 180 mm



Mit Sperre  
 With Lock  
 Con arresto  
 Con cierre  
 Avec Arrêt

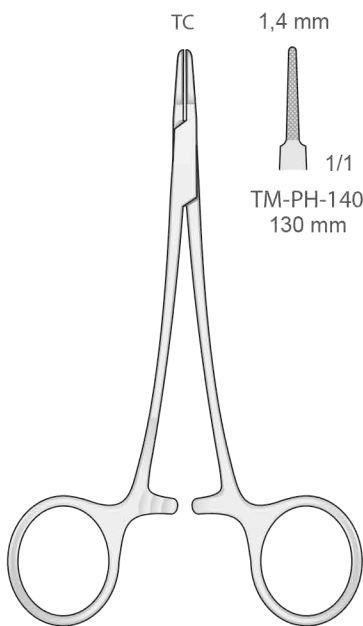
TM-FD-574T/TM-FD-575T  
 180 mm



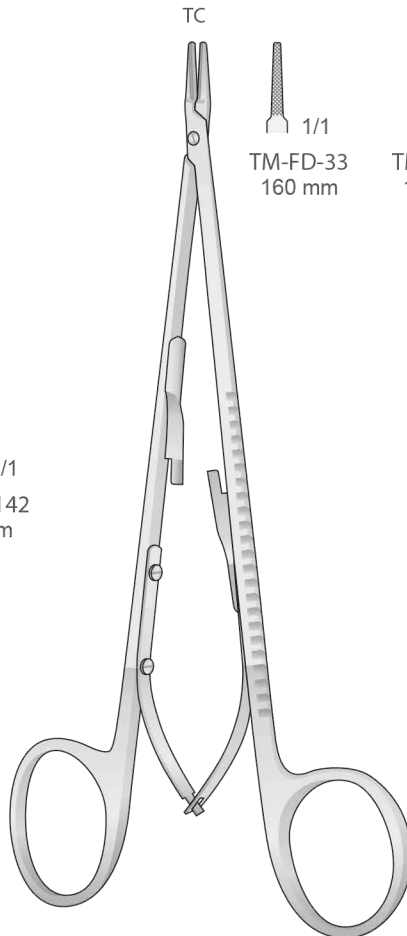
TM-FD-587T/TM-FD-588T  
 180 mm

**Tungsten-Carbide Inserts**

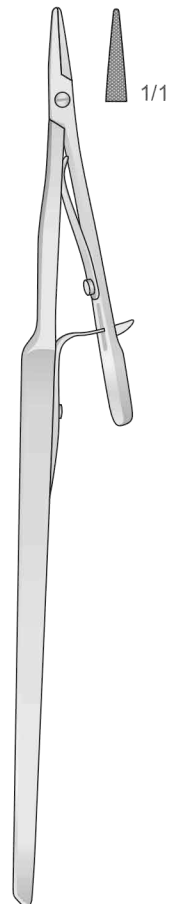
Mit Hartmetalleinsätzen  
Plaquettes en carbure de tungstène  
Plaquetas de carburo de tungsteno  
Inserti in carburo di tungsteno



MICRO-RYDER  
TM-PH-140/TM-PH-142

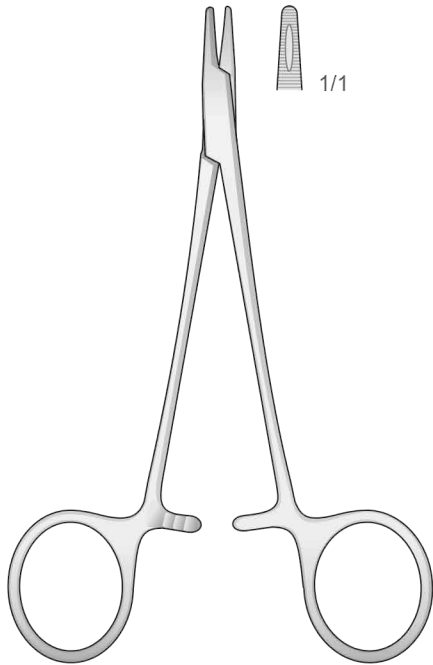


DIETRICH  
TM-FD-33/TM-FD-35

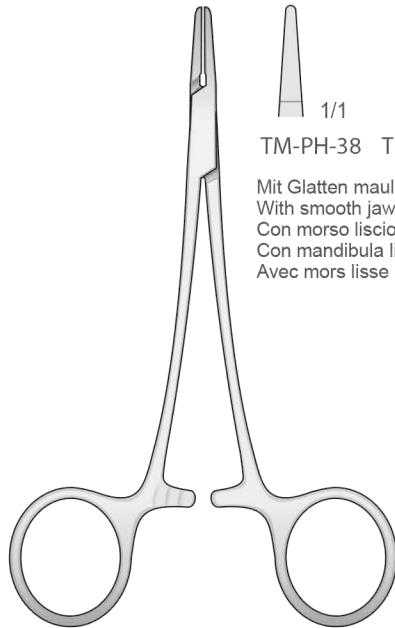


STEVENS  
TM-FD-38  
160 mm

Nadelhalter  
Needle Holders  
Port'aghi  
Portaagujas  
Porte aiguilles

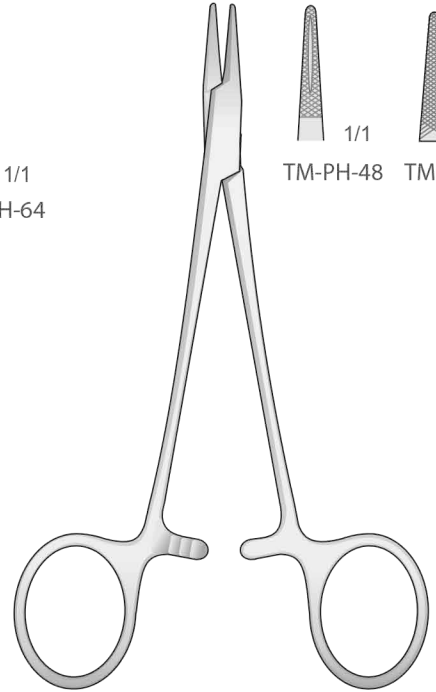


DERF  
TM-PH-39  
125 mm

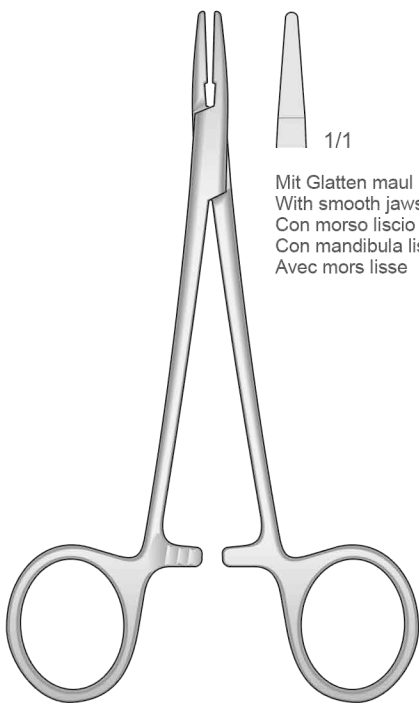


TM-PH-38/TM-PH-64  
120 mm

Mit Glatten maul  
With smooth jaws  
Con morso liscio  
Con mandibula lisa  
Avec mors lisse

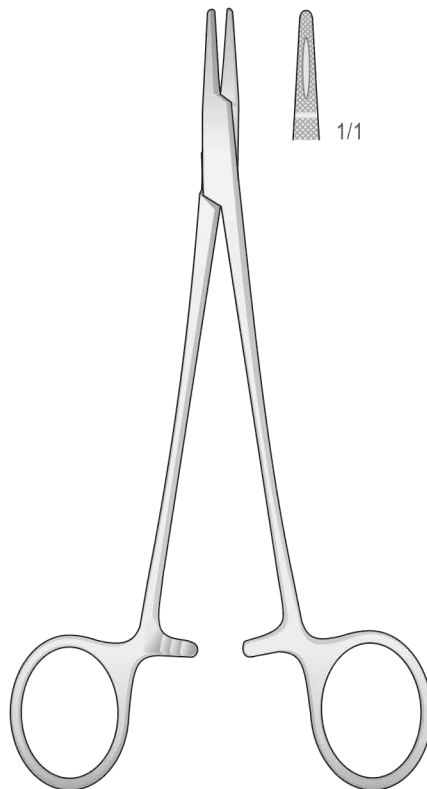


HALSEY  
TM-PH-48/TM-PH-63  
130 mm

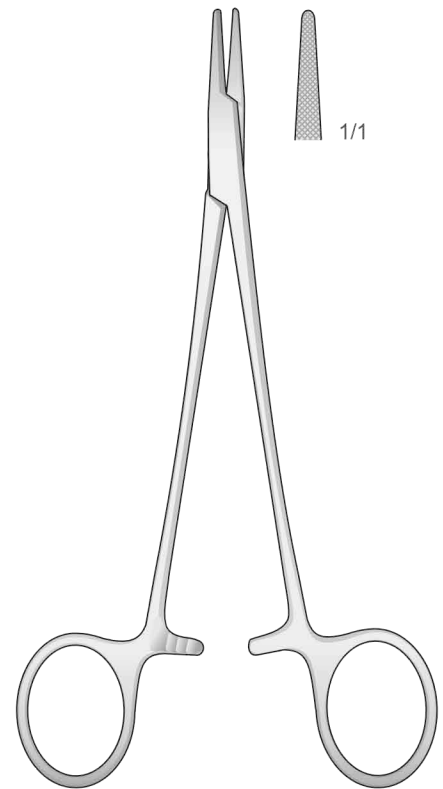


HALSEY  
TM-PH-37  
130 mm

Mit Glatten maul  
With smooth jaws  
Con morso liscio  
Con mandibula lisa  
Avec mors lisse

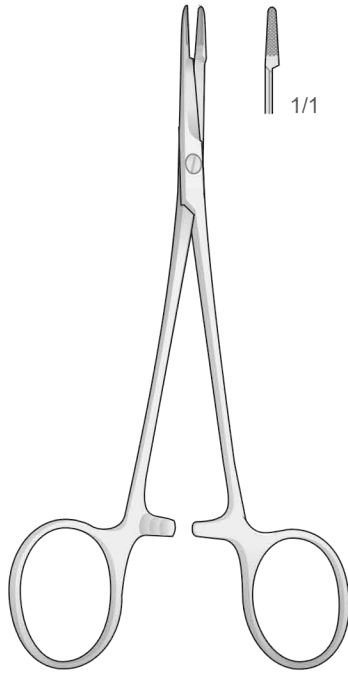


CRILE-WOOD  
TM-PH-61  
150 mm

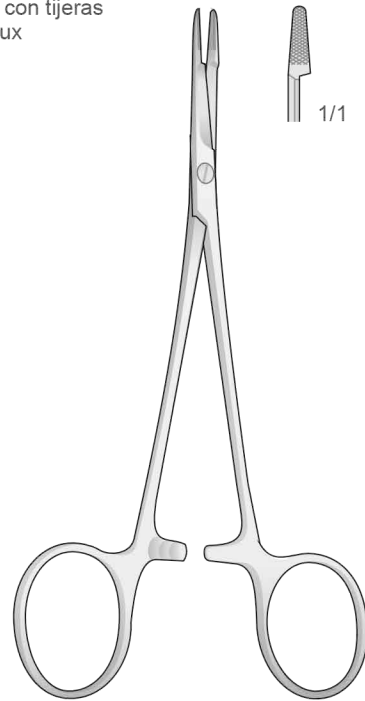


CRILE-MURRAY  
TM-PH-62  
150 mm

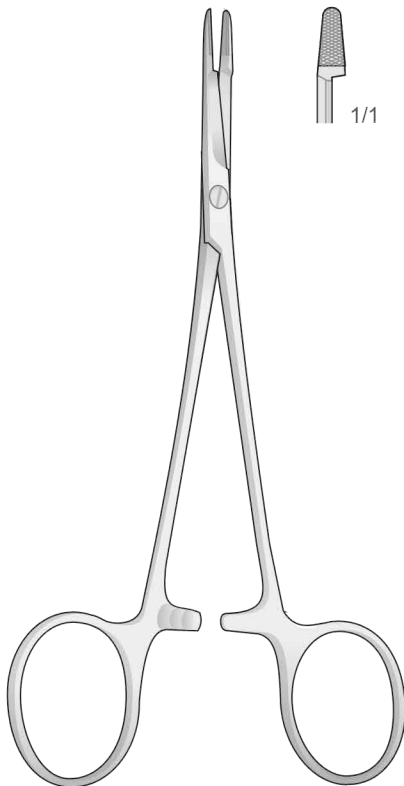
Nadelhalter mit Schere - Needle holders with scissors  
Port'aghi con forbici - Portaagujas con tijeras  
Porte aiguilles avec ciseaux



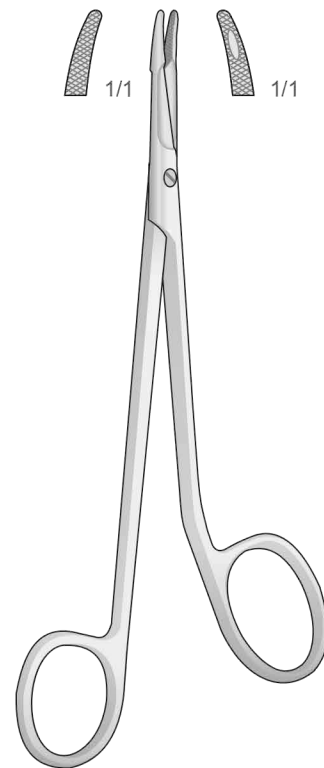
MITM-OLSEN-HEGAR  
TM-BM-61  
120 mm



OLSEN-HEGAR  
TM-BM-62  
140 mm

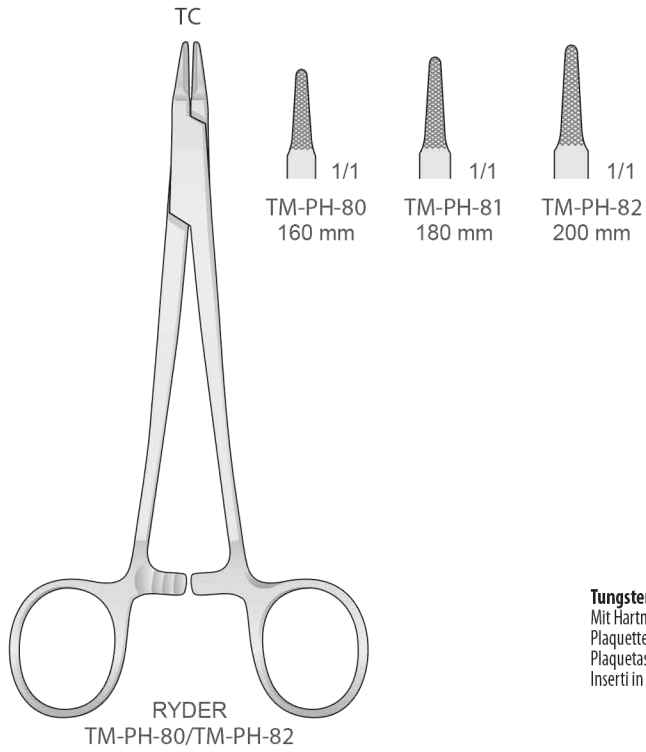


OLSEN-HEGAR  
TM-BM-63  
170 mm

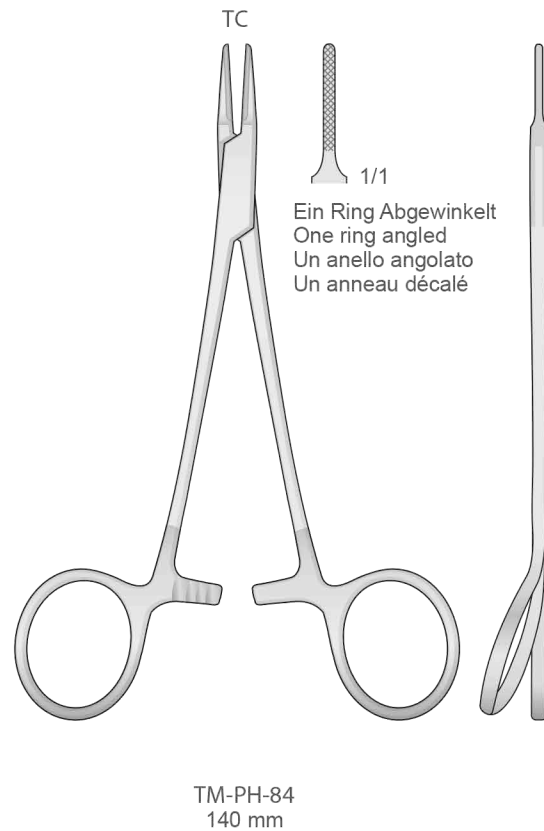
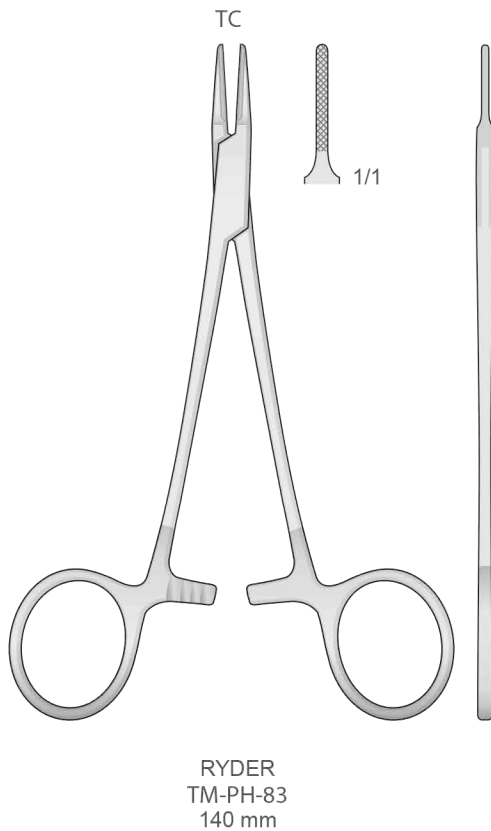


MITM-GILLIES  
TM-PO-59  
145 mm

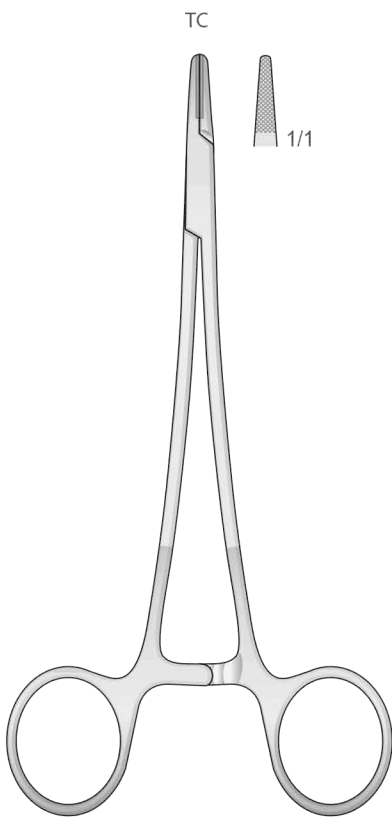
Nadelhalter  
Needle Holders  
Port'aghi  
Portaagujas  
Porte aiguilles



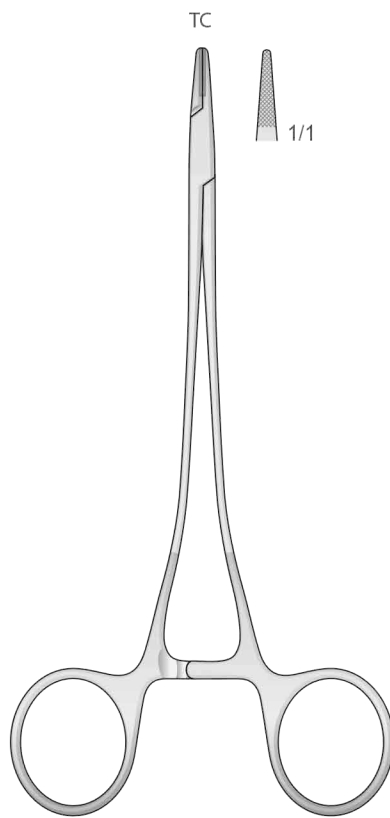
**Tungsten-Carbide Inserts**  
Mit Hartmetalleinsätzen  
Plaquettes en carbure de tungstène  
Plaquetas de carburo de tungsteno  
Inserti in carburo di tungsteno



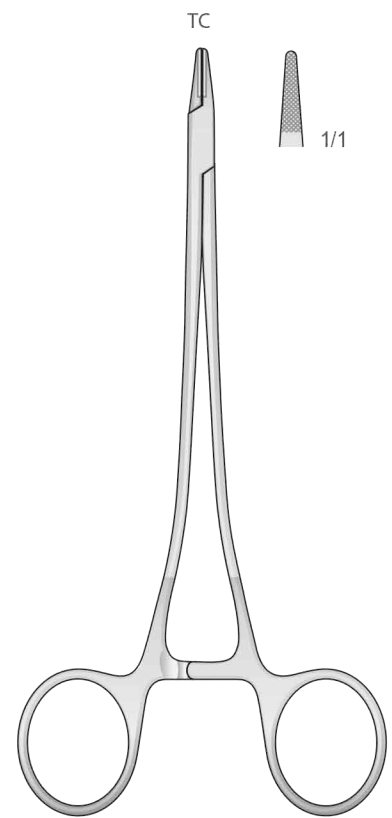
**Tungsten-Carbide Inserts**  
Mit Hartmetalleinsätzen  
Plaquettes en carbure de tungstène  
Plaquetas de carburo de tungsteno  
Inserti in carburo di tungsteno



TM-PH-79  
145 mm



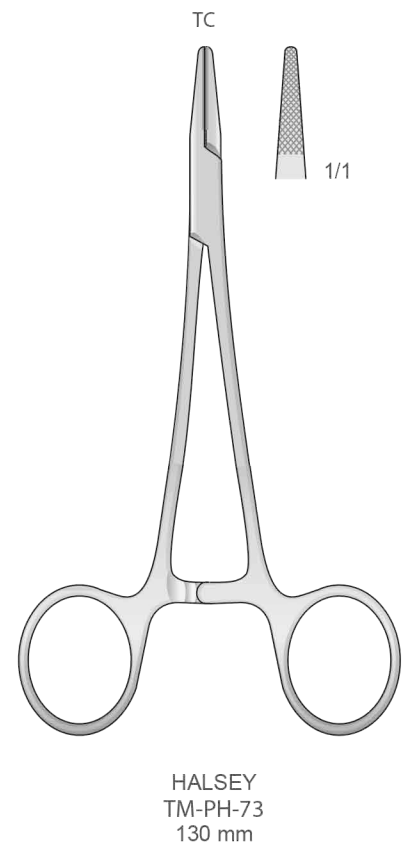
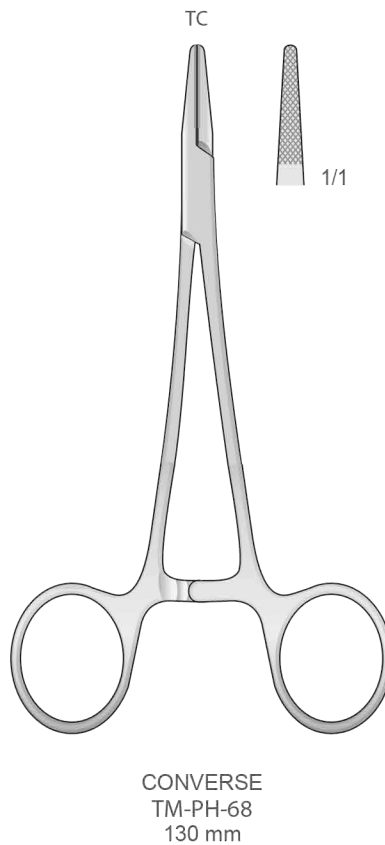
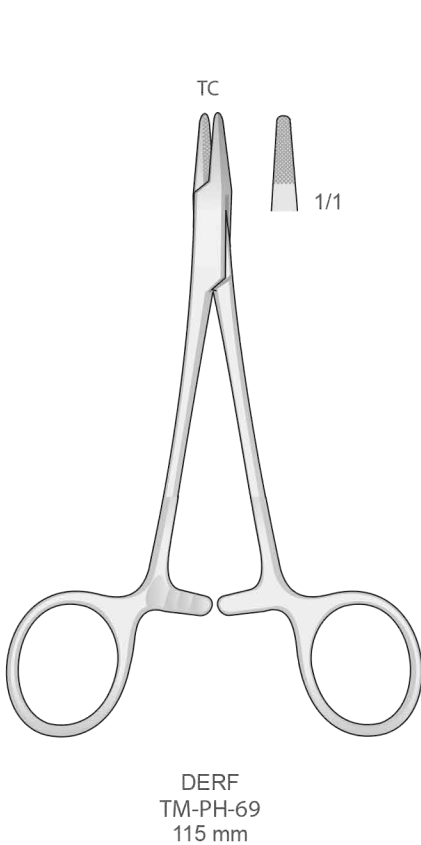
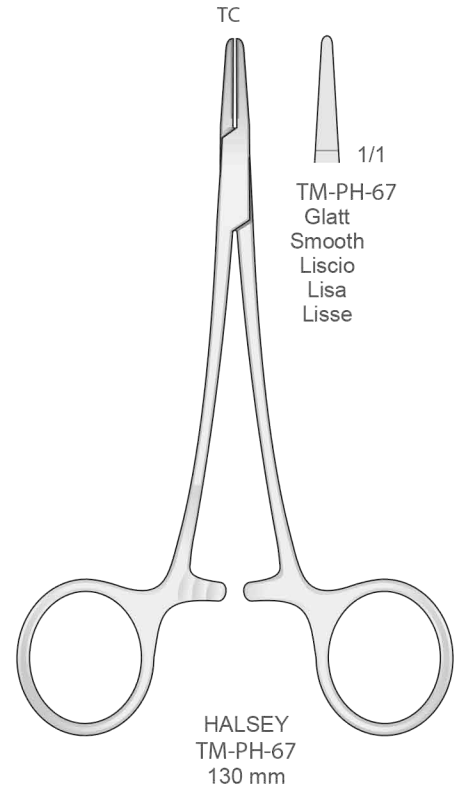
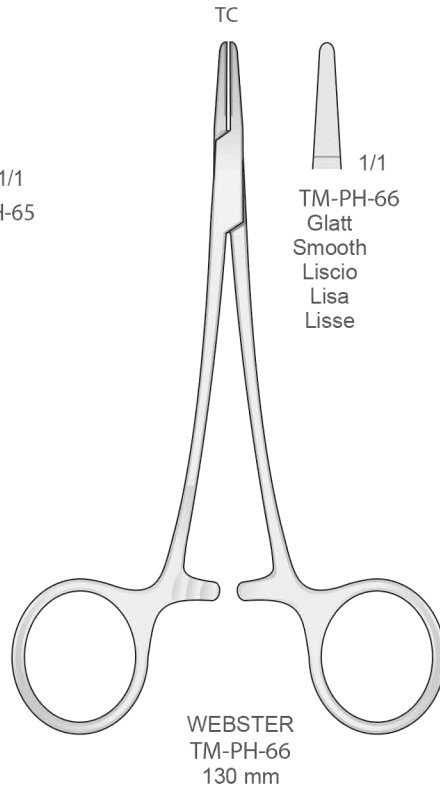
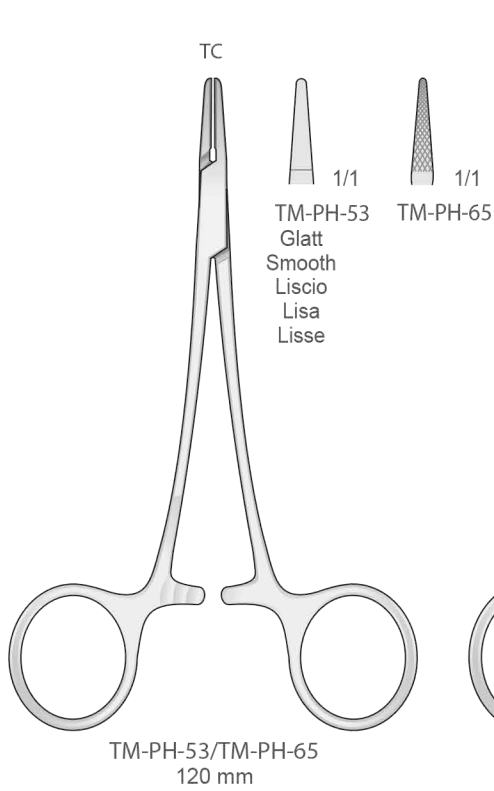
FINE SWEDISH PATTERN  
TM-PH-85  
150 mm



SWEDISH MOD.  
TM-PH-106  
150 mm

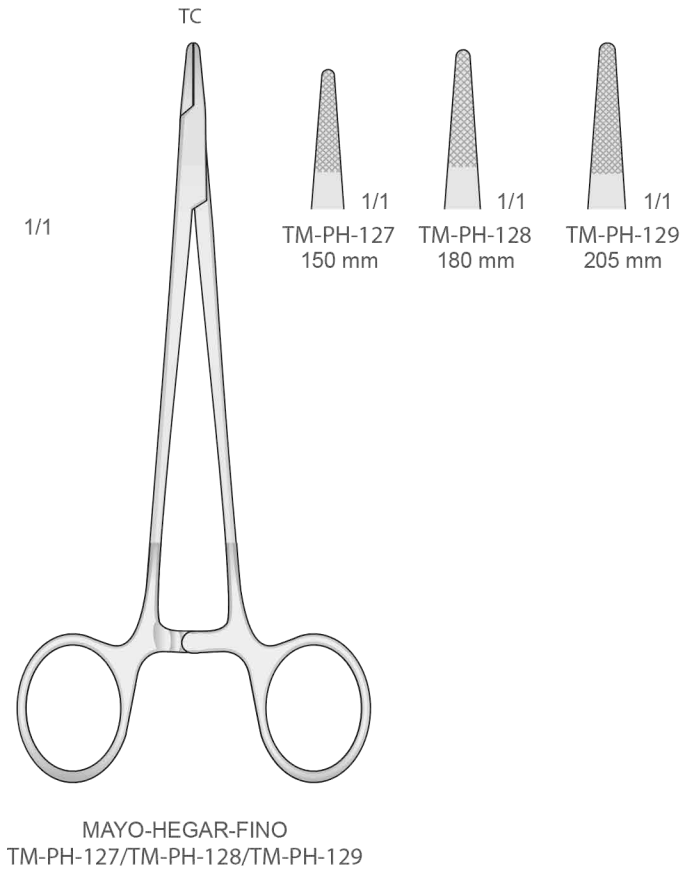
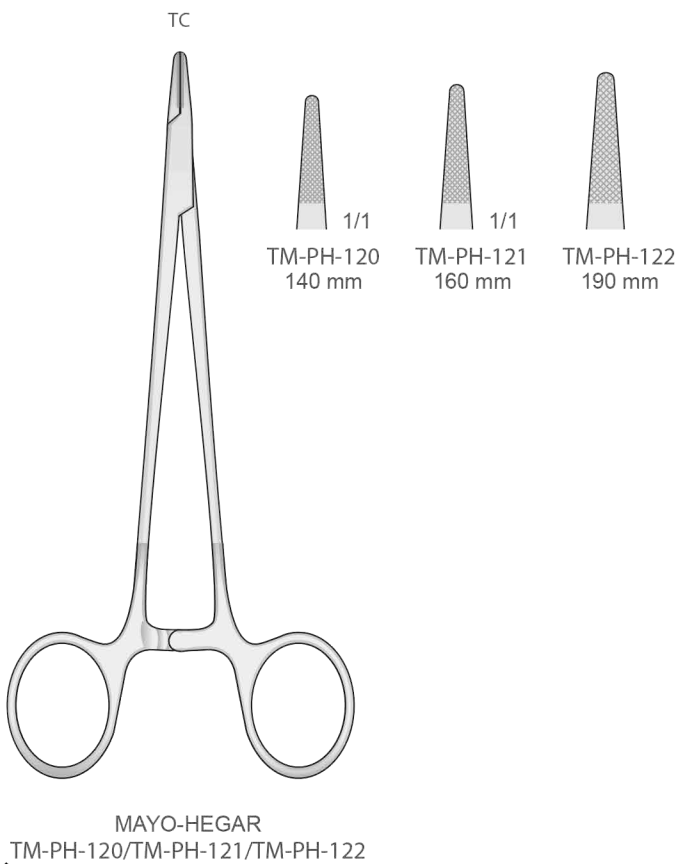
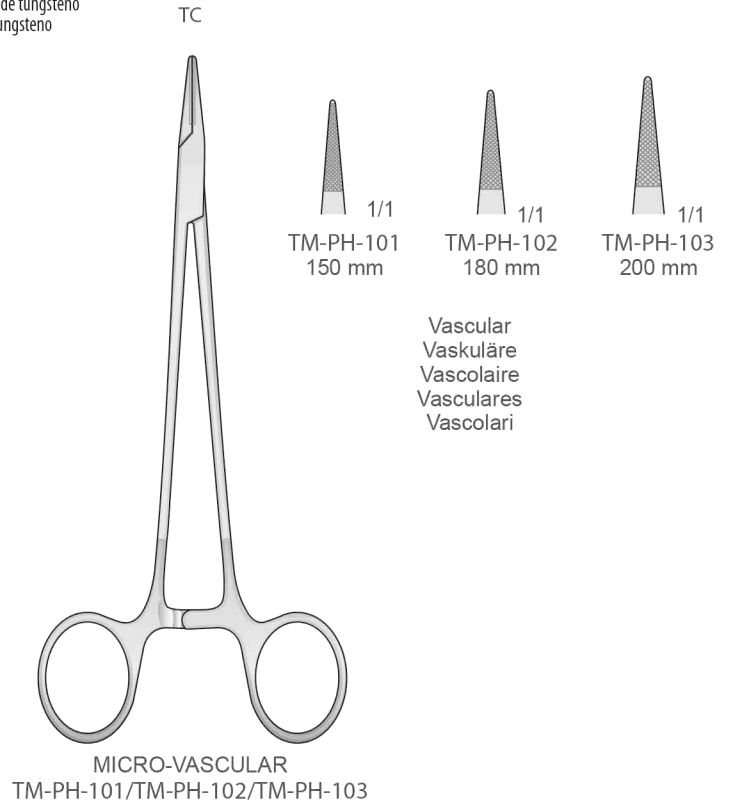
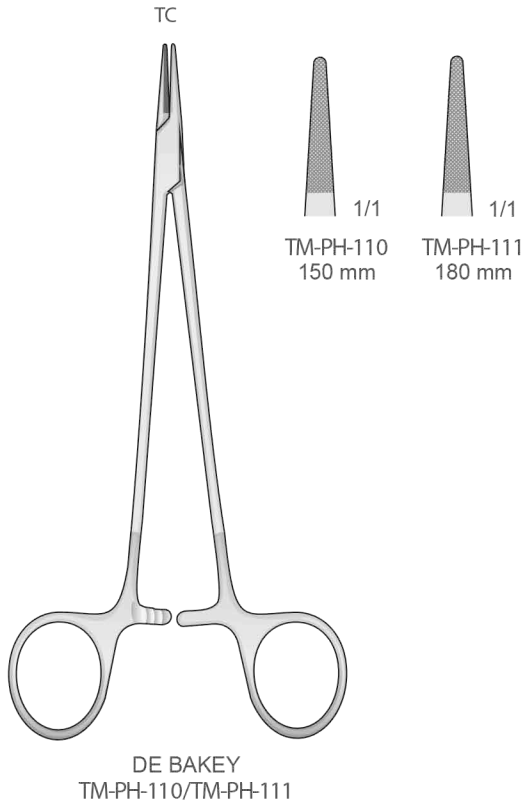
Nadelhalter  
Needle Holders  
Port'aghi  
Portaagujas  
Porte aiguilles

**Tungsten-Carbide Inserts**  
Mit Hartmetalleinsätzen  
Plaquettes en carbure de tungstène  
Plaquetas de carburo de tungsteno  
Inserti in carburo di tungsteno



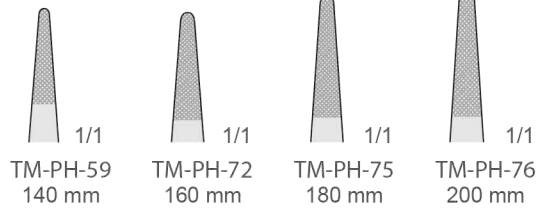
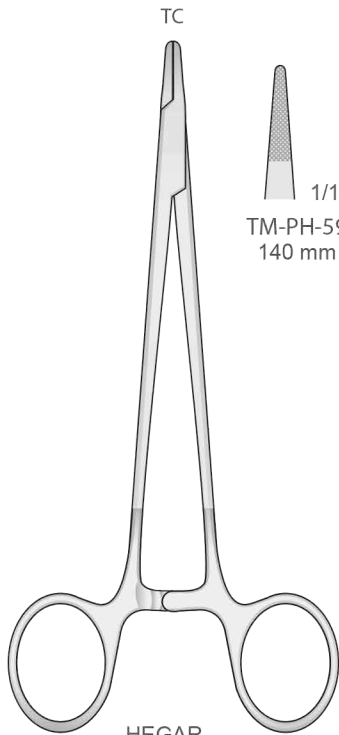


**Tungsten-Carbide Inserts**  
Mit Hartmetalleinsätzen  
Plaquettes en carbure de tungstène  
Plaquetas de carburo de tungsteno  
Inserti in carburo di tungsteno

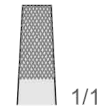
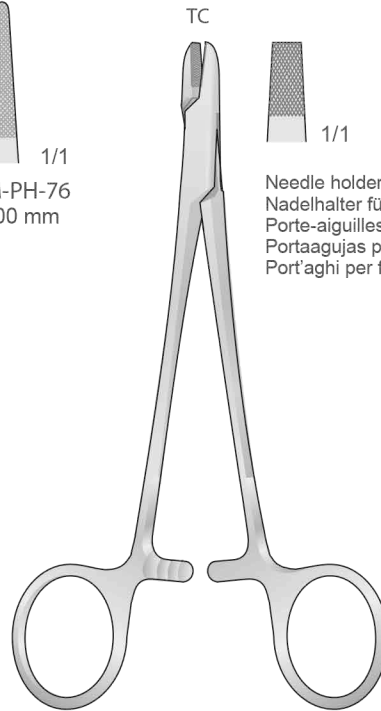


Nadelhalter  
Needle Holders  
Port'aghi  
Portaagujas  
Porte aiguilles

**Tungsten-Carbide Inserts**  
Mit Hartmetalleinsätzen  
Plaquettes en carbure de tungstène  
Plaquetas de carburo de tungsteno  
Inserti in carburo di tungsteno

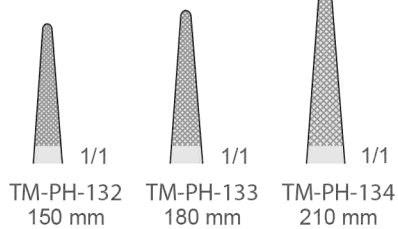
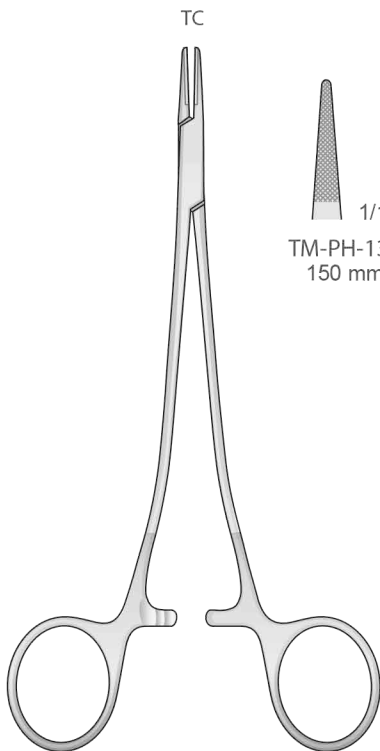


HEGAR  
TM-PH-59/TM-PH-72/TM-PH-75/TM-PH-76

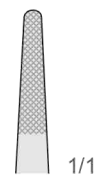
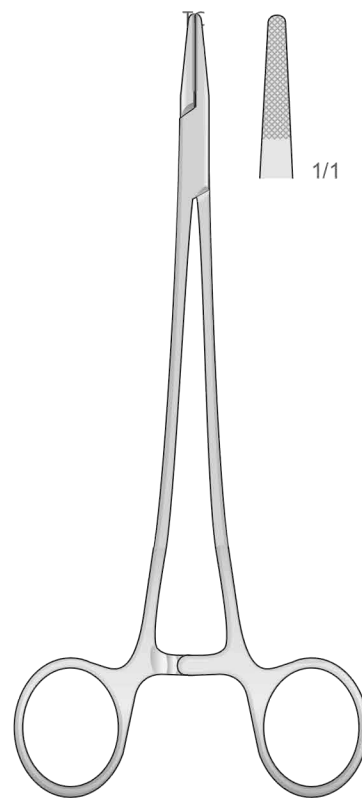


Needle holders for wire  
Nadelhalter für drähte  
Porte-aiguilles pour fil métallique  
Portaagujas para hilo metálico  
Port'aghi per fili metallici

TM-PH-58  
150 mm

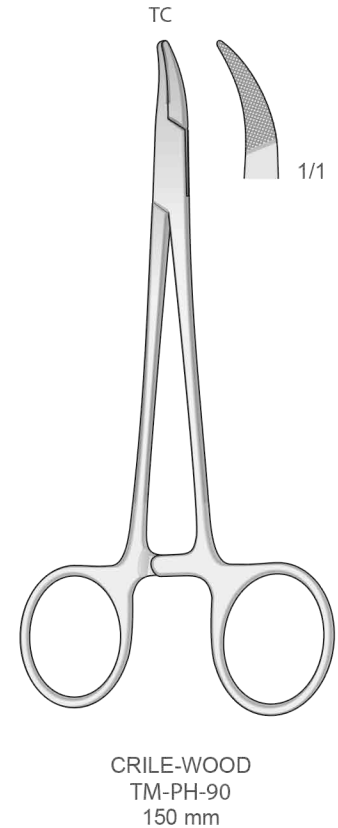
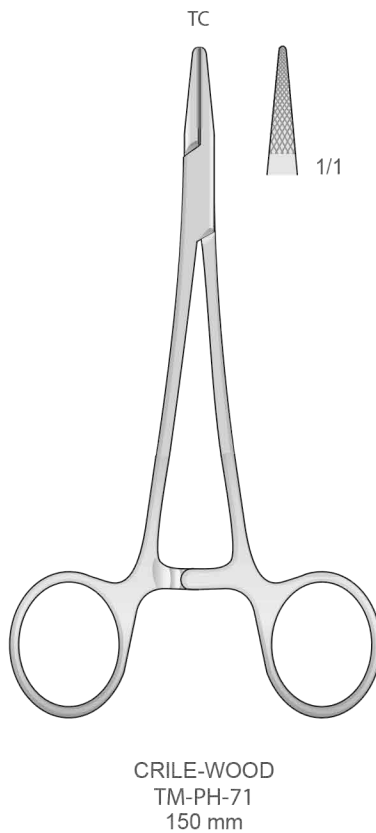
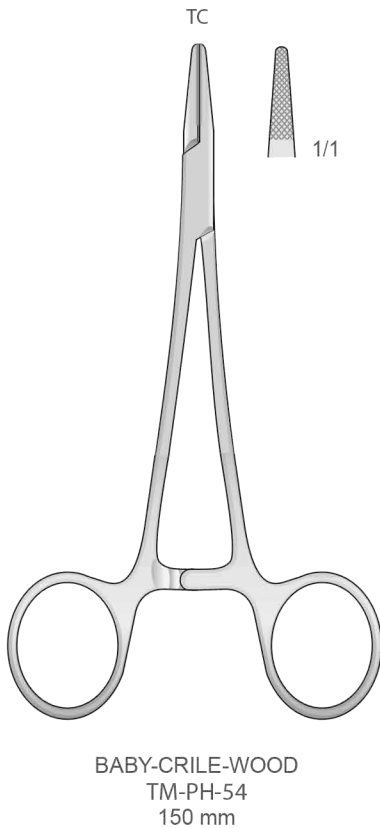
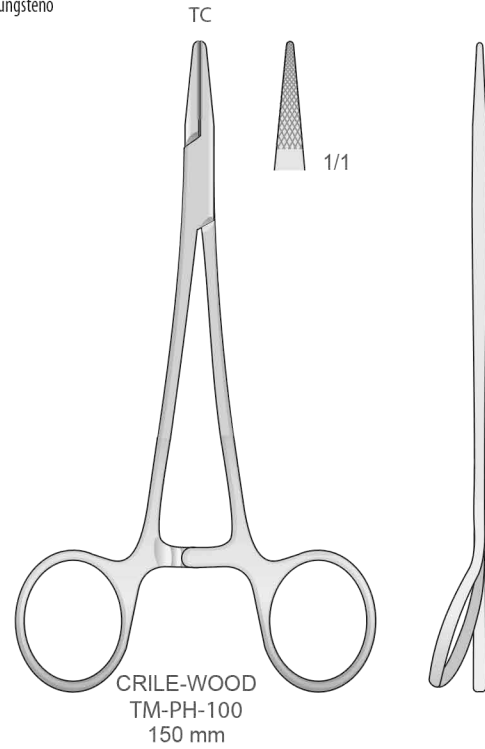
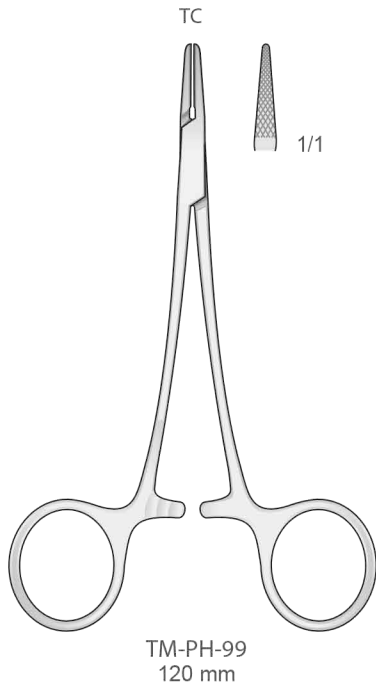


SAROT  
TM-PH-132/TM-PH-133/TM-PH-134



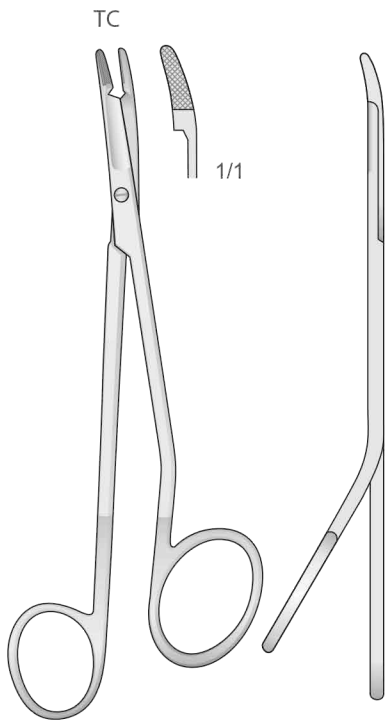
CRILE-WOOD  
TM-PH-77  
180 mm

**Tungsten-Carbide Inserts**  
Mit Hartmetalleinsätzen  
Plaquettes en carbure de tungstène  
Plaquetas de carburo de tungsteno  
Inserti in carburo di tungsteno

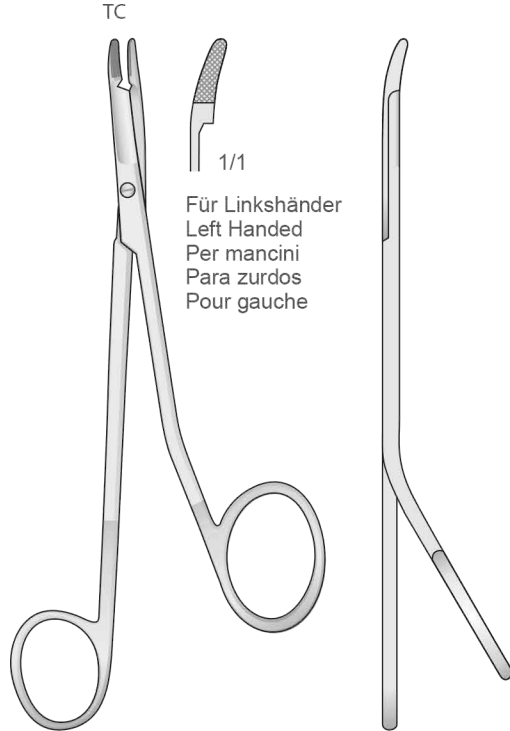


Nadelhalter  
Needle Holders  
Port'aghi  
Portaagujas  
Porte aiguilles

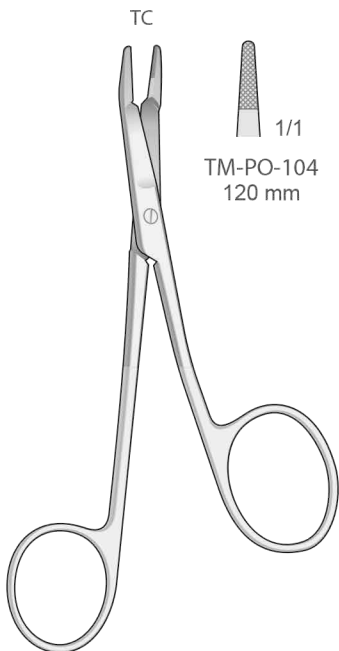
**Tungsten-Carbide Inserts**  
Mit Hartmetalleinsätzen  
Plaquettes en carbure de tungstène  
Plaquetas de carburo de tungsteno  
Inserti in carburo di tungsteno



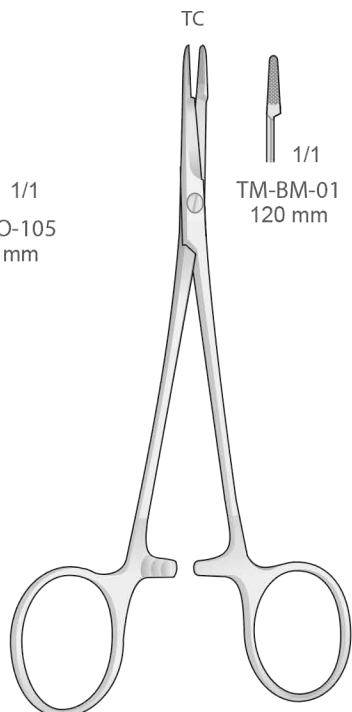
MITM-GILLIES  
TM-PO-99  
145 mm



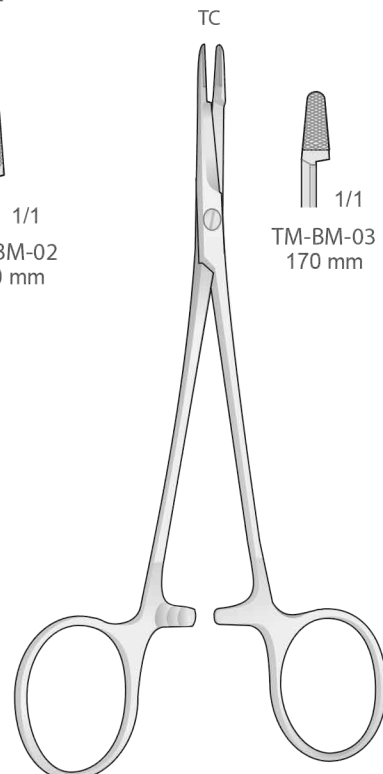
MITM-GILLIES  
TM-PO-99L  
145 mm



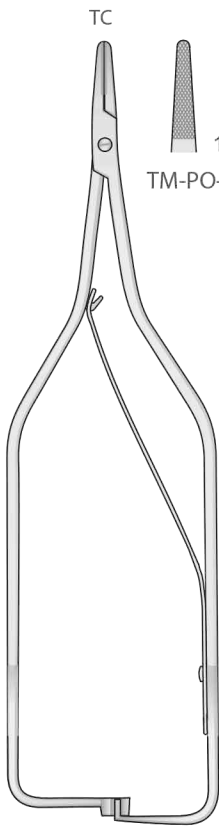
FOSTER-GILLIES  
TM-PO-104/TM-PO-105  
120 mm



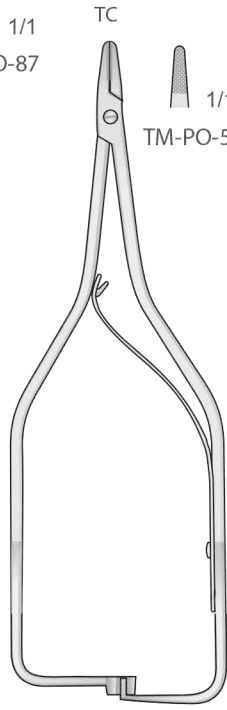
OLSEN-HEGAR  
TM-BM-01/TM-BM-02



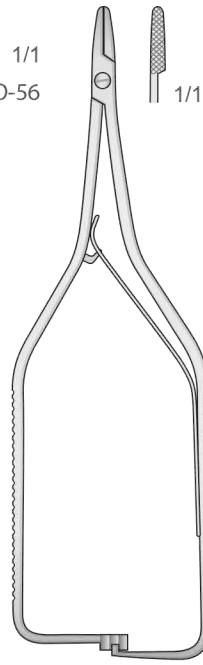
OLSEN-HEGAR  
TM-BM-03/TM-BM-04



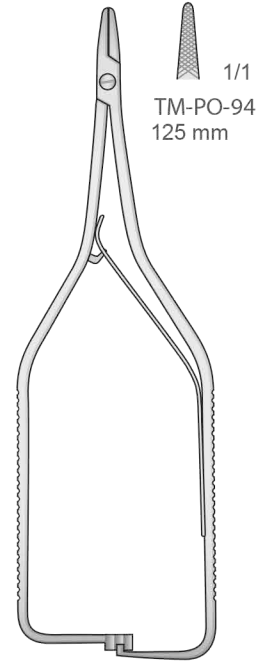
ARRUGA  
TM-PO-85/TM-PO-87  
160 mm



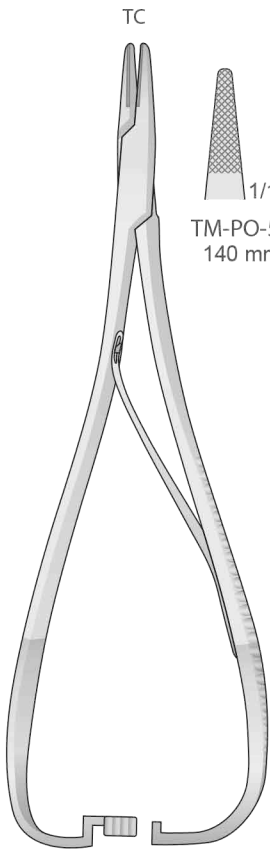
BOYNTON  
TM-PO-55/TM-PO-56  
120 mm



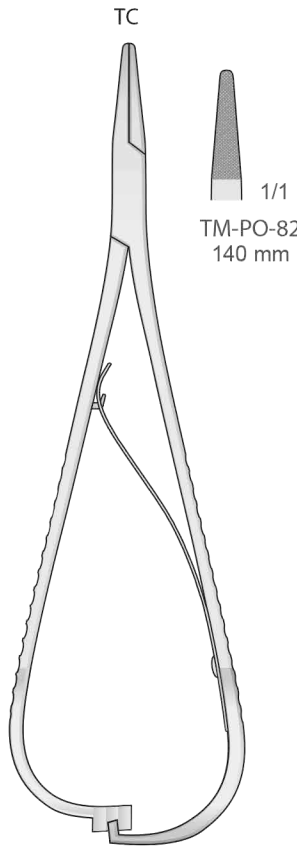
BOYNTON  
TM-PO-88  
120 mm



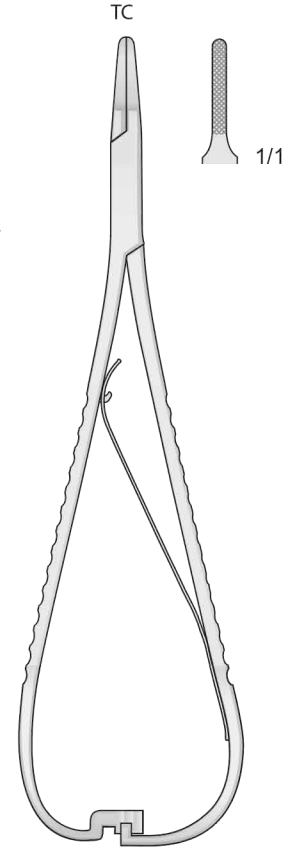
BOYNTON  
TM-PO-94  
125 mm



MATHIEU  
TM-PO-50/TM-PO-52

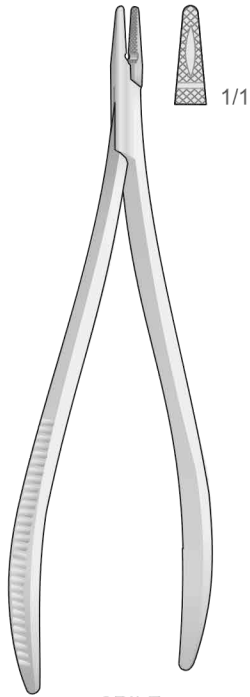


MATHIEU  
TM-PO-82/TM-PO-84

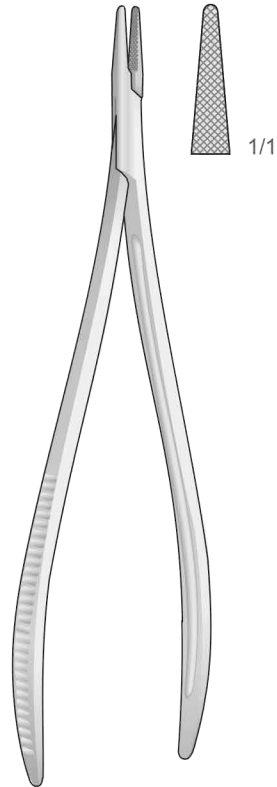


LICHTENBERG  
TM-PO-86  
175 mm

Nadelhalter  
Needle Holders  
Port'aghi  
Portaagujas  
Porte aiguilles

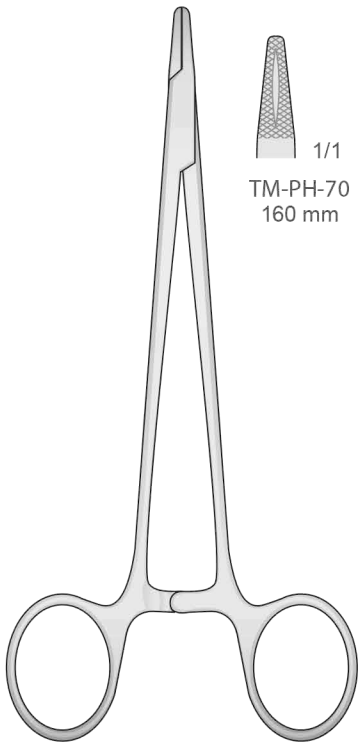


CRILE  
TM-PO-37  
150 mm

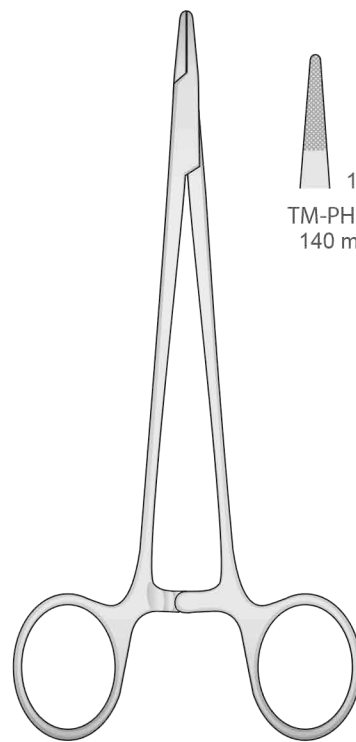
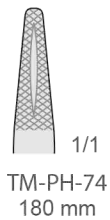
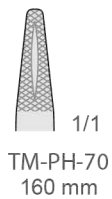


TÖNNIS  
TM-PO-38  
190 mm

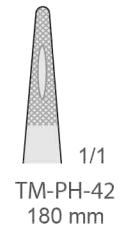
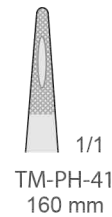
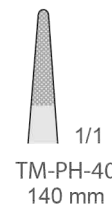
Schlankesmodell - Delicate pattern - Modello fine  
Modelo delegado - Modèle fin

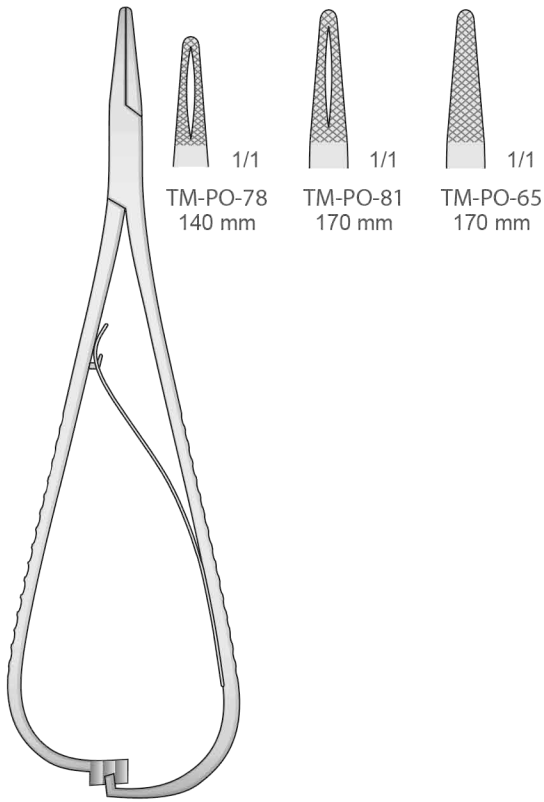


HEGAR  
TM-PH-70/TM-PH-74

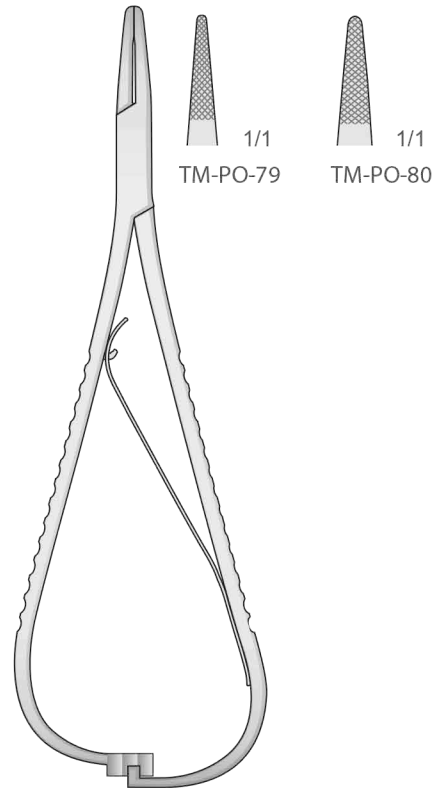


MAYO-HEGAR  
TM-PH-40/TM-PH-42

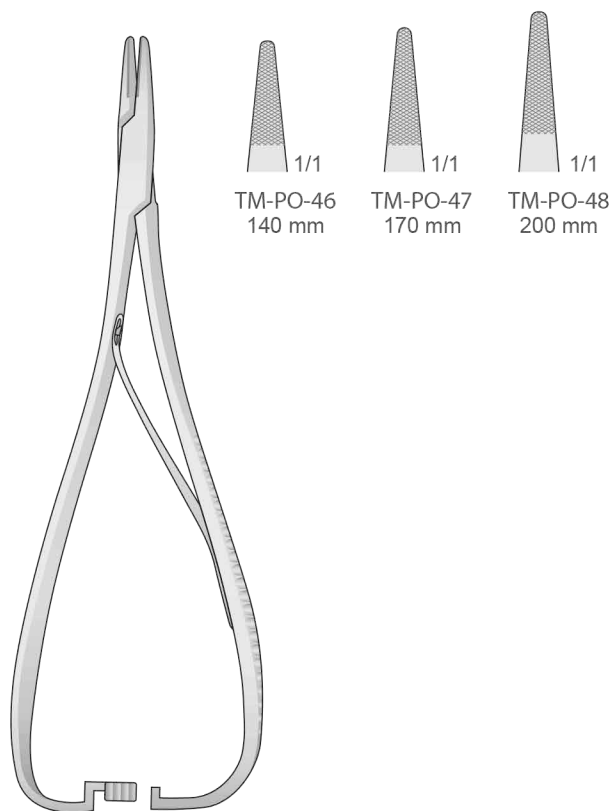




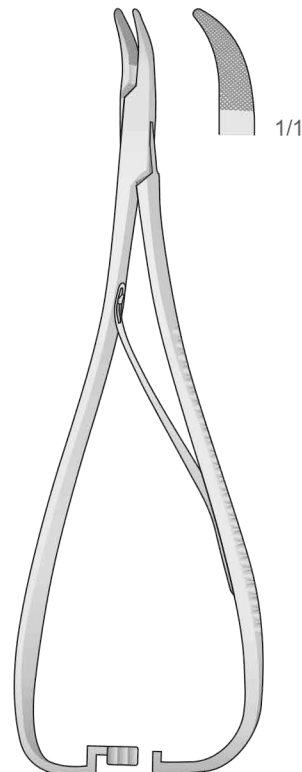
MATHIEU  
TM-PO-65/TM-PO-81



MATHIEU  
TM-PO-79/TM-PO-80  
140 mm

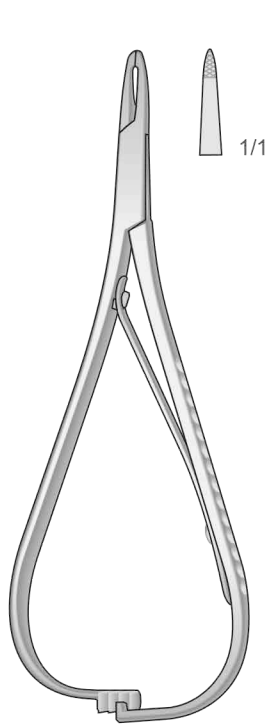


MATHIEU  
TM-PO-46/TM-PO-48

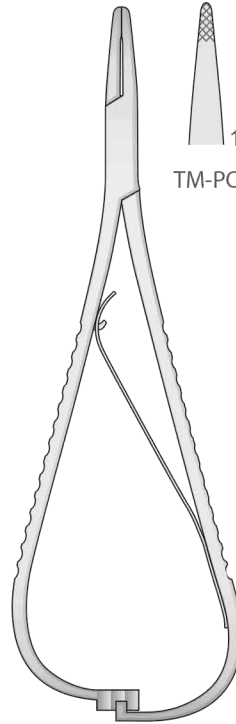
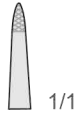


TM-PO-40  
140 mm

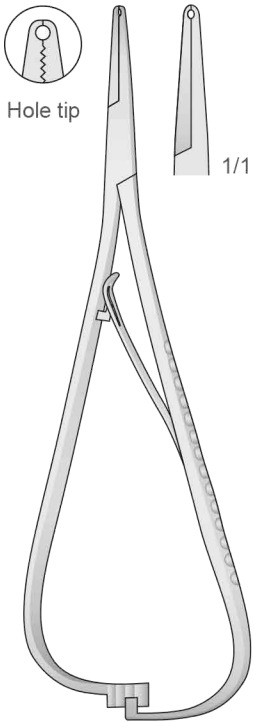
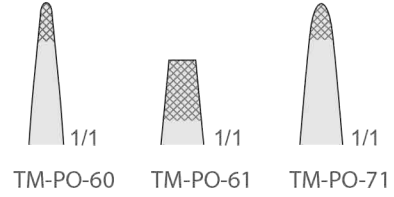
Nadelhalter  
Needle Holders  
Port'aghi  
Portaagujas  
Porte aiguilles



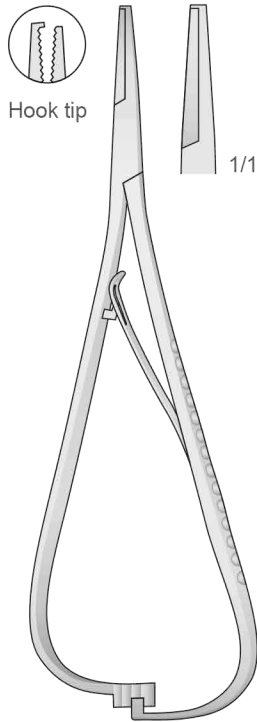
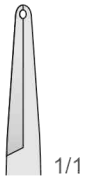
MATHIEU  
TM-PO-45  
125 mm



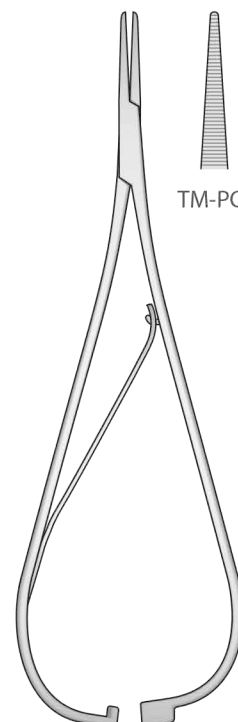
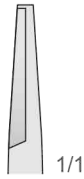
MATHIEU  
TM-PO-60/TM-PO-71  
140 mm



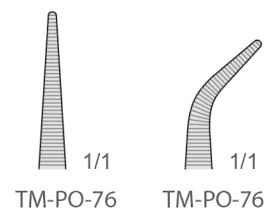
SMAHA  
TM-PO-68  
140 mm



SMAHA  
TM-PO-69  
140 mm

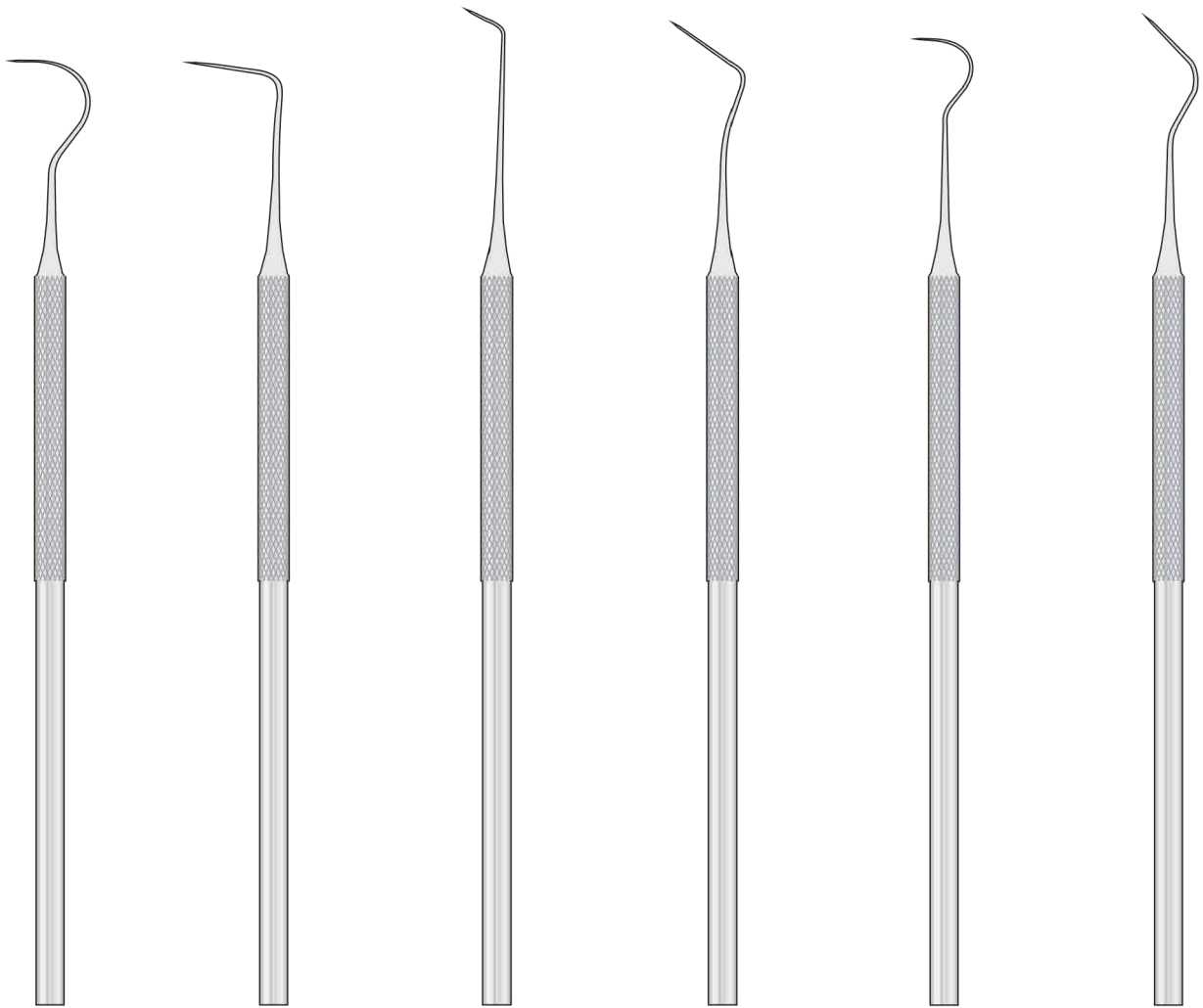


SMAHA  
TM-PO-76/TM-PO-77  
140 mm





Zahnsonden  
Explorers - Sickle Probes  
Esploratori - Sonde falce  
Sondas exploradoras  
Sondes exploratrices



TM-SO-1  
Fig. 23

TM-SO-2  
Fig. 11

TM-SO-3  
Fig. 6

TM-SO-4  
Fig. 9

TM-SO-5  
Fig. 2

TM-SO-6  
Fig. 10



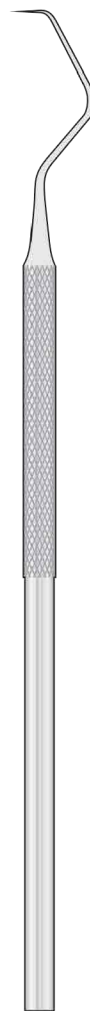
TM-SO-7  
Fig. 12



TM-SO-8  
Fig. 6A



TM-SO-9  
Fig. 8A



TM-SO-10  
Fig. 17A



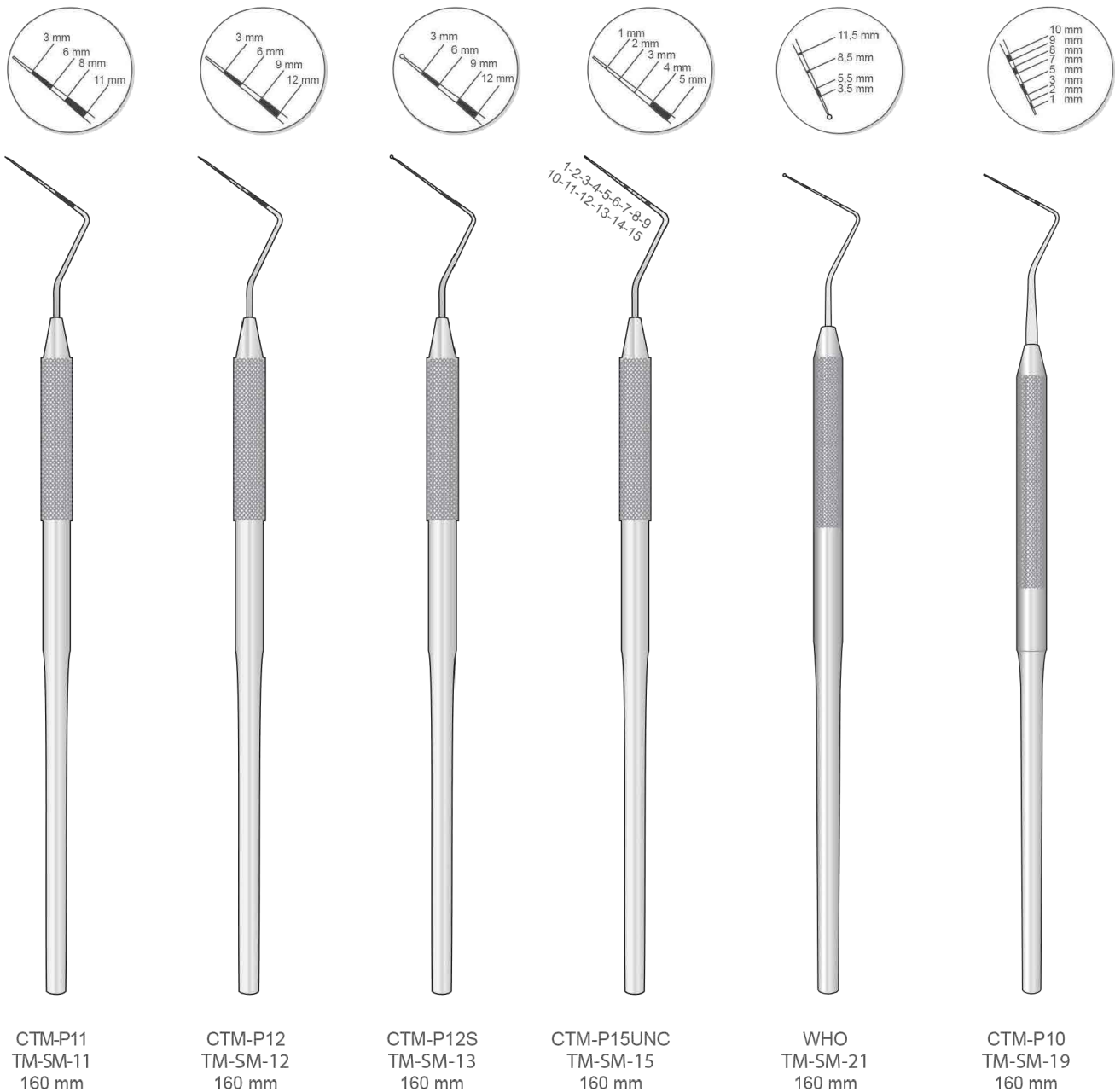
TM-SO-11  
Fig. 3A



TM-SO-12  
Fig. 3

Parodontometer  
Periodontal Probes  
Sonde parodontali  
Sondas parodontales  
Sondes parodontales

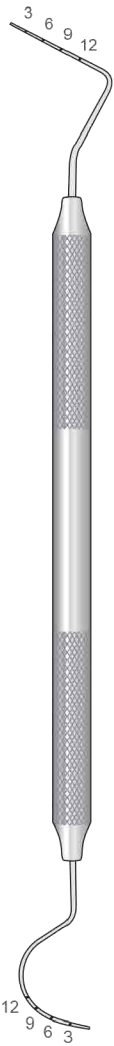
Do not sterilizing with ultra sound - Not Metal brushes  
Non sterilizzare in ultrasuoni - No spazzola metallica



Double-ended Explorer  
Doppelendiger Zahnsonden  
Sonde esploratrice double  
Sonda exploradora doble  
Sonda falce doppia



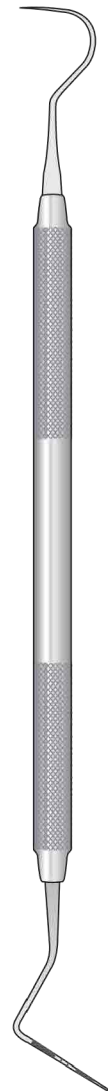
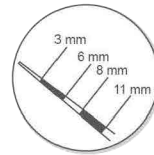
11/12 ODU  
TM-SO-20  
165 mm



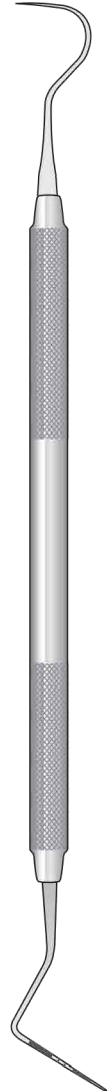
UT3/4 CATTONI  
TM-SM-20  
165 mm



2QN NABERS  
TM-SM-22  
175 mm



23 CTMP-P11  
TM-EX-11



23 CTM-P12  
TM-EX-12

Parodontometer  
Periodontal Probes  
Sonde parodontali  
Sondas parodontales  
Sondes parodontales



WILLIAMS  
TM-SM-1

MERRITT A  
TM-SM-2

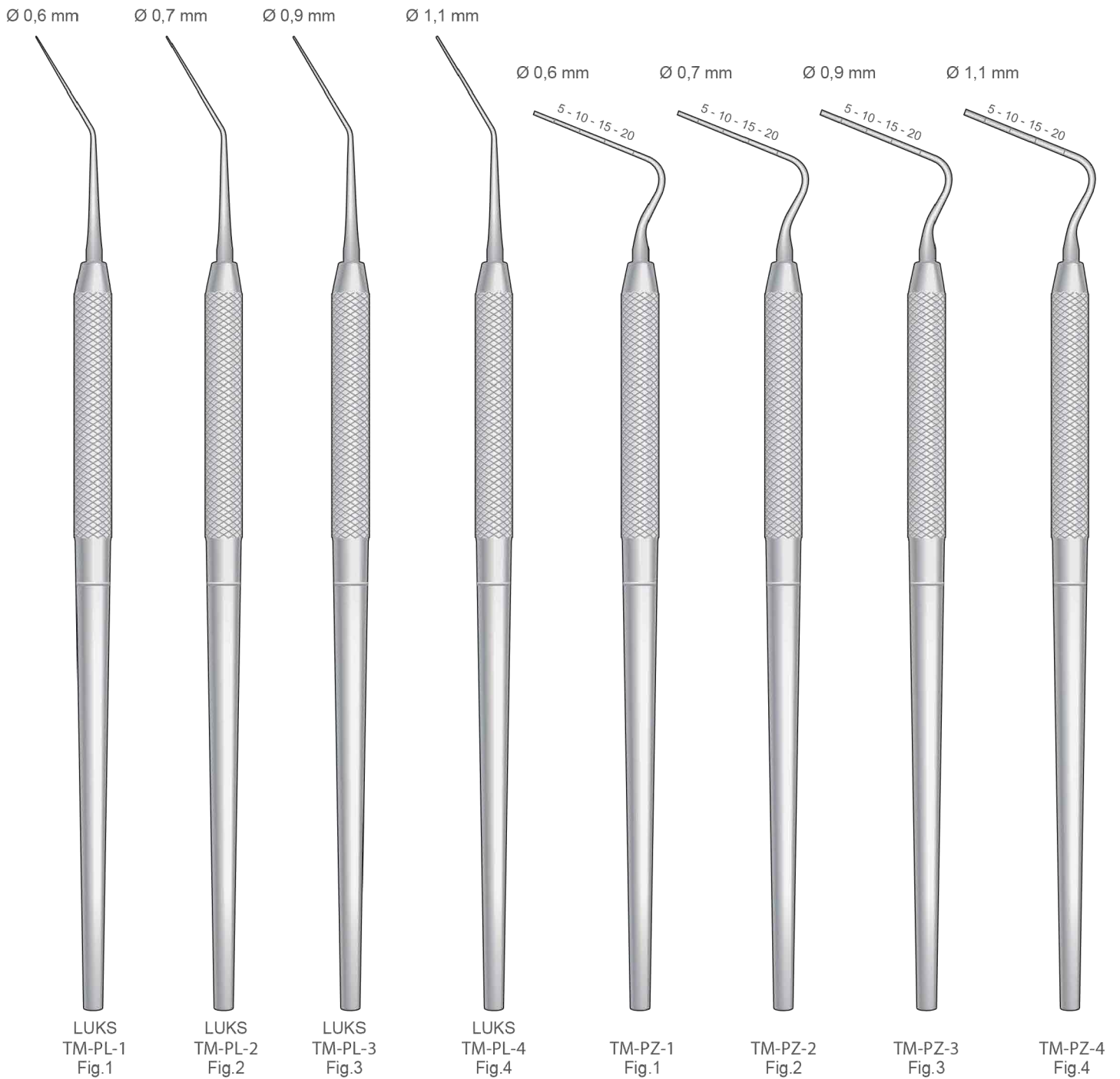
MERRITT B  
TM-SM-3

GOLDMAN-FOX  
TM-SM-4

Flat  
Flach  
Plan  
Plano  
Piatto

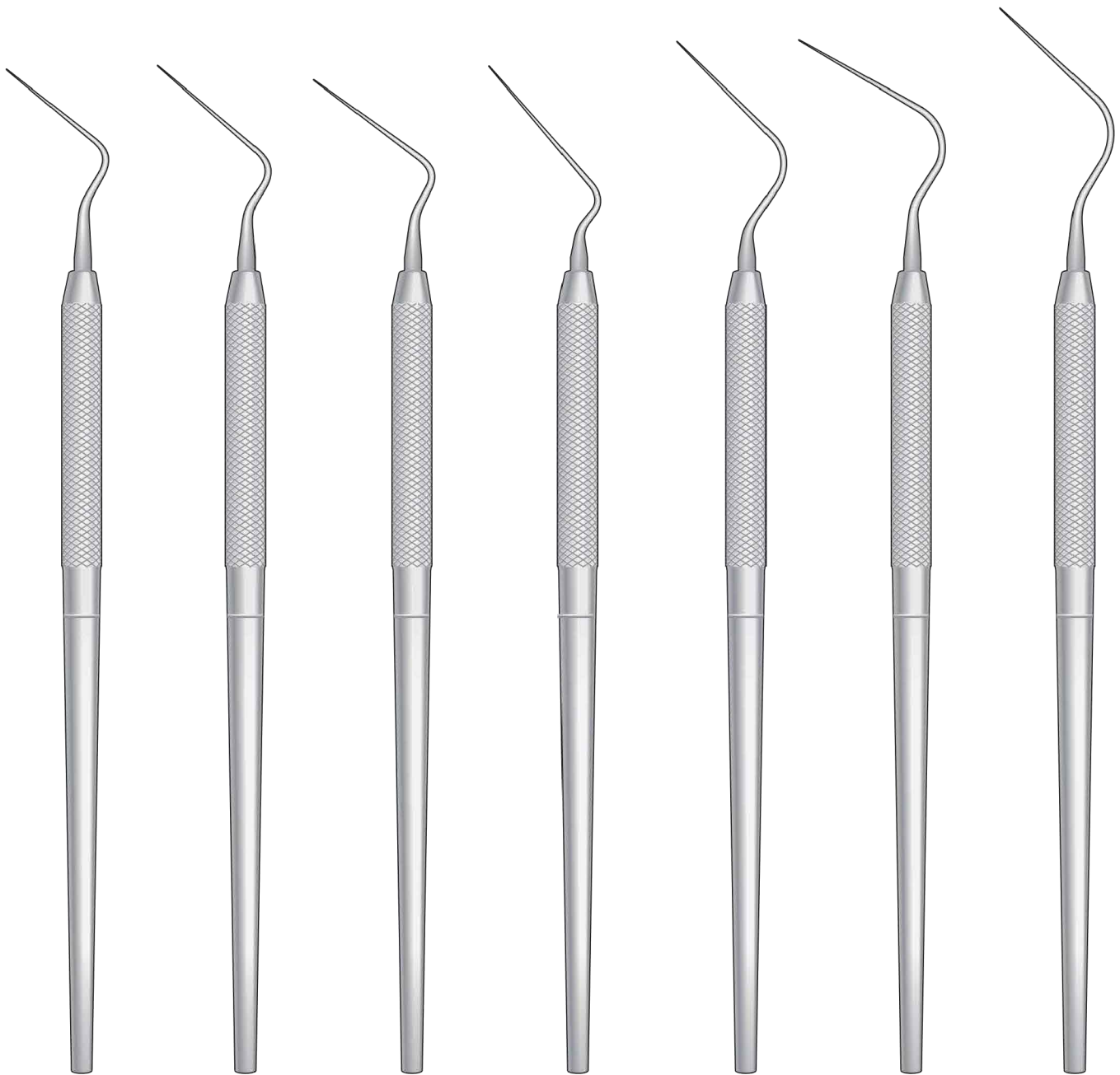
UNIVERSITY  
OF MICHIGAN  
TM-SM-5

26 G  
TM-SM-6



Instrumente für Endodontie  
Endodontic Instruments  
Strumenti per Endodonzia  
Instrumentos para Endodoncia  
Instruments pour Endodontie

Spreaders



TM-STM-P1  
Fig.1S

TM-STM-P2  
Fig.2S

TM-STM-P3  
Fig.D11

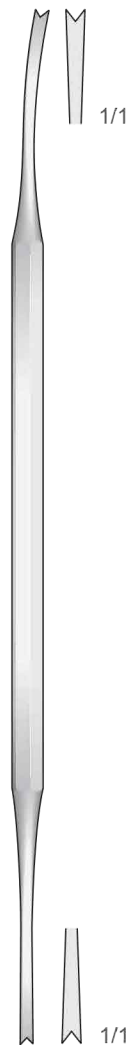
TM-STM-P4  
Fig.MA57

TM-STM-P5  
Fig.0

TM-STM-P6  
Fig.00

TM-STM-P7  
Fig.3

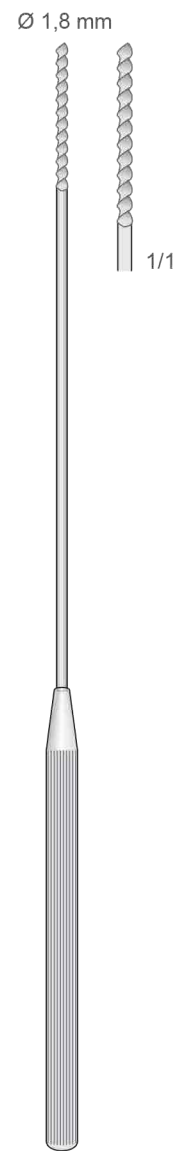
Tamponstopfer  
Gauze Packers  
Porta tamponi  
Portatampones  
Porte tampons



LUNIATSCHEK  
TM-PF-6  
170 mm



UNIVERSAL  
TM-PF-40  
140 mm



UNIVERSAL  
TM-PF-41  
180 mm



Mundspiegel und Griffe  
 Mirrors and handles  
 Specchiotti e manici  
 Espejos y mangos  
 Miroirs et manches

Box of 12

|       |              |  |
|-------|--------------|--|
| TM-P3 | # 3 - Ø 18mm | Flach<br>Plane<br>Piano<br>Plano<br>Plan |
| TM-P4 | # 4 - Ø 22mm |  |
| TM-P5 | # 5 - Ø 24mm |  |

Rhodiumspiegel  
 Rhodium Mirror  
 Specchietto rodiato  
 Espejo de rodio  
 Miroir au rhodium

Box of 12

|         |              |
|---------|--------------|
| TM-RH-4 | # 4 - Ø 22mm |
| TM-RH-5 | # 5 - Ø 24mm |

Simple Stem

|          |
|----------|
| TM-RH-4A |
| TM-RH-5A |

Cone Socket

Box of 12

|        |              |   |
|--------|--------------|---|
| TM-G-3 | # 3 - Ø 18mm | Hohl-Vergrößernd<br>Concave with enlarging effect<br>Concavo con ingrandimento<br>Còncavo con efecto de aumento<br>Creux avec effect d'agrandissant |
| TM-G-4 | # 4 - Ø 22mm |   |
| TM-G-5 | # 5 - Ø 24mm |   |

Box of 6

|          |              |
|----------|--------------|
| TM-RH-14 | # 4 - Ø 22mm |
|----------|--------------|

MEGA DUO  
 RHODIUM n.4

Beidseitig Rhodium Beschichtet  
 Both sides Rhodium-coated  
 Con rivestimento in rodio su entrambi i lati  
 Revestido con rodio en ambos lados  
 Revêtu de rhodium des deux côtés

Massiv - Solid  
 Pieno - Sólido - Solide

Hohl - Hollow  
 Vuoto - Hueco - Creux

TM-MA-1  
 Simple Stem  
 120 mm

TM-MA-1A  
 Cone Socket  
 120 mm

TM-MA-2  
 Simple Stem  
 125 mm

TM-MA-2A  
 Cone Socket  
 125 mm

inox STAINLESS STEEL

TM-AL-MA5  
 120 mm

TM-MA-3  
 125 mm

TM-MA-7  
 135 mm

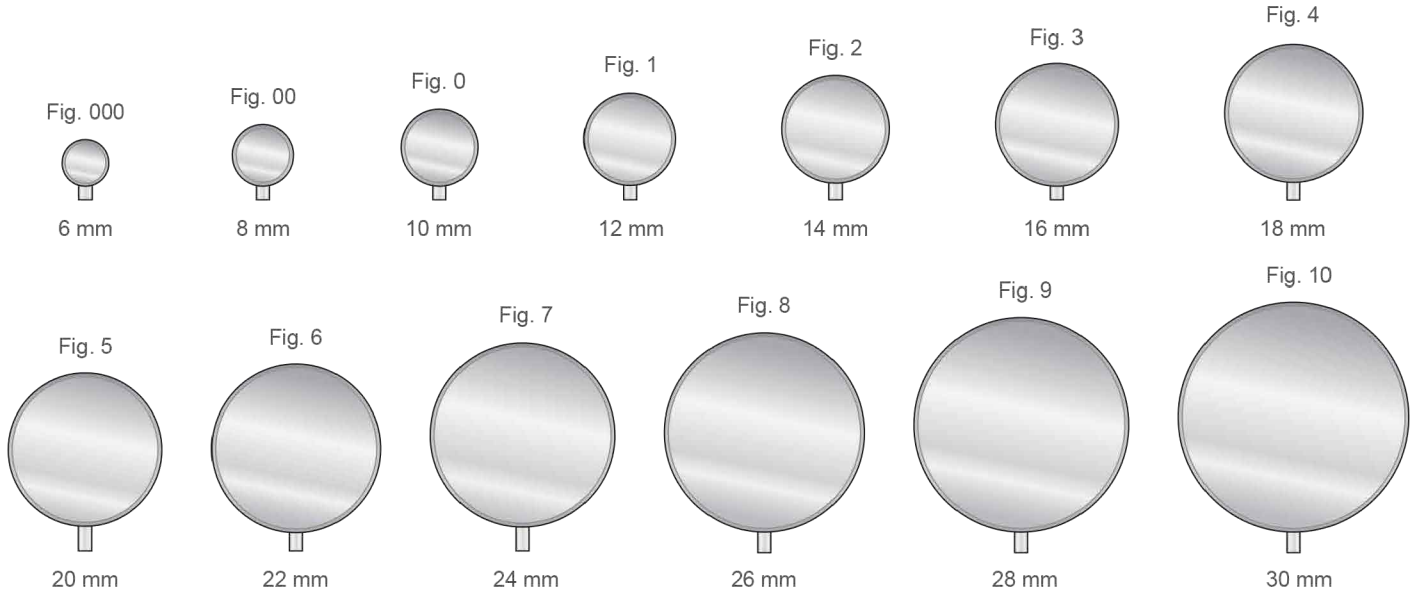
Cr CHROMIUM

Al ALUMINIUM

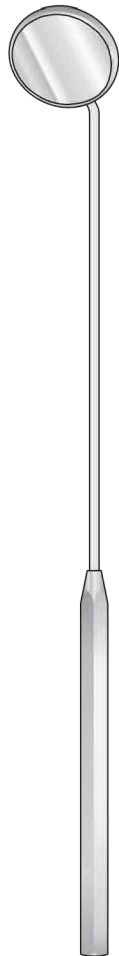
inox STAINLESS STEEL



Spiegeldurchmesser - Diameter of mirrors  
Diametro dello specchio - Diamètre des miroirs  
Diámetro de los espejos



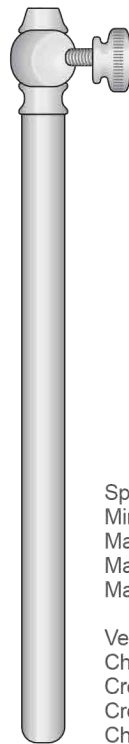
Inox



Kehlkopfspiegel mit Sechskantgriff  
Laryngeal mirrors with hexagonal handle  
Specchietto laringeo con manico esagonale  
Espejo laringeo con mango hexagonal  
Miroirs laryngiens avec manche hexagonal

- TM-G-8 Fig. 00
- TM-G-10 Fig. 0
- TM-G-12 Fig. 1
- TM-G-14 Fig. 2
- TM-G-16 Fig. 3
- TM-G-18 Fig. 4
- TM-G-20 Fig. 5
- TM-G-22 Fig. 6
- TM-G-24 Fig. 7
- TM-G-26 Fig. 8
- TM-G-28 Fig. 9
- TM-G-30 Fig. 10

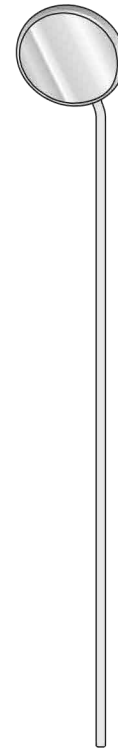
TM-G-8/TM-G-30  
180 mm



Spiegelgriff  
Mirrors handle  
Manico per specchietti  
Mango para espejos  
Manche à miroir

Verchromt  
Chromium  
Cromato  
Cromado  
Chromé

TM-MA-6  
120 mm



Kehlkopfspiegel  
Laryngeal mirrors  
Specchietto laringeo  
Espejos laringeos  
Miroirs laryngiens

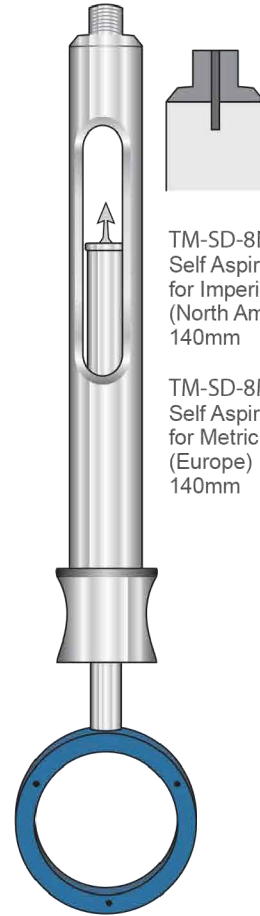
- TM-P000 Fig. 000
- TM-P00 Fig. 00
- TM-P0 Fig. 0
- TM-P01 Fig. 1
- TM-P02 Fig. 2
- TM-P03 Fig. 3
- TM-P04 Fig. 4
- TM-P05 Fig. 5
- TM-P06 Fig. 6

TM-P000/TM-P06  
120 mm

Dental-Spritzen  
Dental Syringes  
Siringhe dentali  
Jeringas dentales  
Seringues dentaires



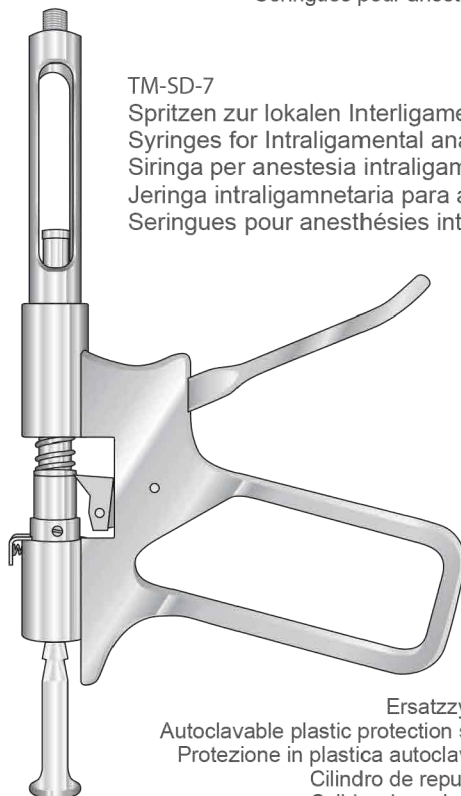
TM-SD-8  
Aspirating  
for Imperial Tip  
(North America)  
140mm



TM-SD-8NA  
Self Aspirating  
for Imperial Tip  
(North America)  
140mm

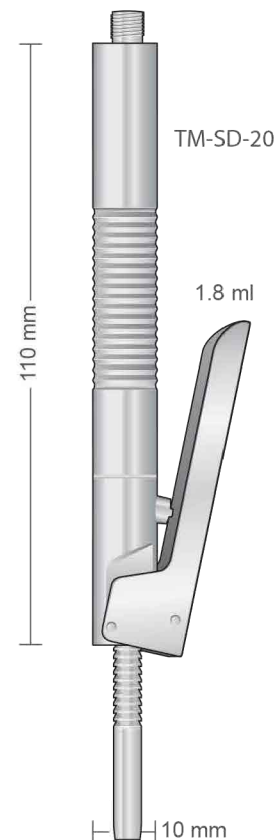
TM-SD-8M  
Self Aspirating  
for Metric Tip  
(Europe)  
140mm

Spritzen zur lokalen Interligamentär-Anästhesie  
Syringes for Intraligamental anaesthesia  
Siringa per anestesia intraligamentare  
Jeringa intraligamentaria para anestesia  
Seringues pour anesthésies intraligementaires



TM-SD-7  
Spritzen zur lokalen Interligamentär-Anästhesie  
Syringes for Intraligamental anaesthesia  
Siringa per anestesia intraligamentare  
Jeringa intraligamentaria para anestesia  
Seringues pour anesthésies intraligementaires

TM-SD-7R  
Ersatzzylinder für TM-SD-7  
Autoclavable plastic protection sleeve for TM-SD-7  
Protezione in plastica autoclavabile per TM-SD-7  
Cilindro de repuesto para TM-SD-7  
Cylindre de rechange pour TM-SD-7



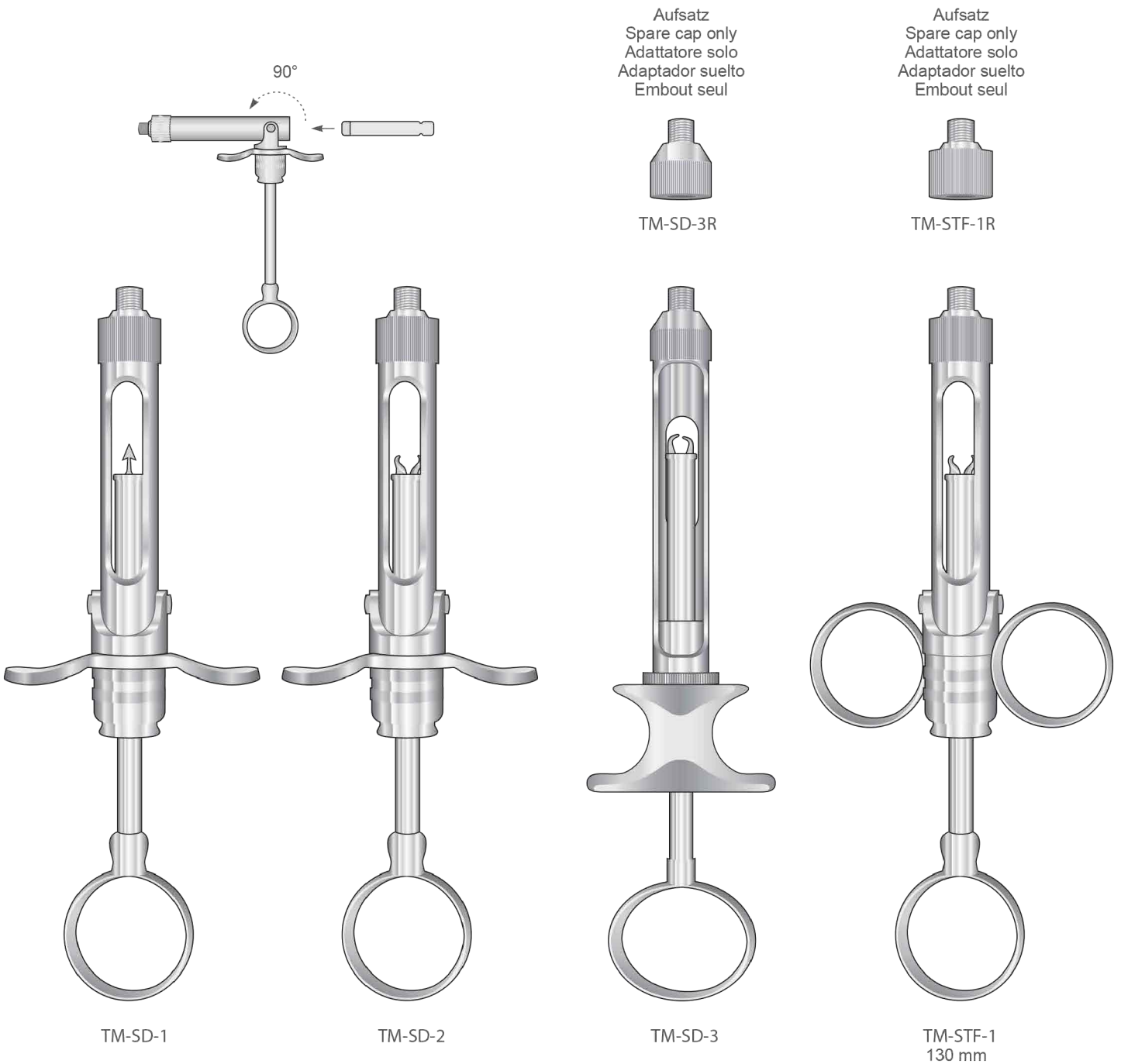
TM-SD-20

1.8 ml

110 mm

10 mm

Zylinder-Ampullen Spritzen  
Cartridge Syringes  
Siringhe per tubofiale  
Jeringas de ampollas  
Seringues d'ampoules



Küretten  
Curettes  
Curette  
Curetas  
Curettes



GRACEY  
TM-CU-1/2



GRACEY  
TM-CU-3/4



GRACEY  
TM-CU-5/6



GRACEY  
TM-CU-7/8



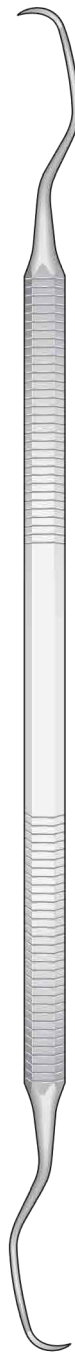
GRACEY  
TM-CU-9/10



GRACEY  
TM-CU-11/12



GRACEY  
TM-CU-13/14



LANGER Fig.1/2  
TM-COL-1/2



LANGER Fig.3/4  
TM-COL-3/4



COLUMBIA  
TM-COL-2RL



COLUMBIA  
TM-COL-4RL



COLUMBIA  
TM-COL-13/14



Hollow  
Hohl  
Creux  
Hueco  
Vuoto



Ø9 mm



TM-USG-1/2ET  
Gracey  
Curette 1/2ET



TM-USG-3/4ET  
Gracey  
Curette 3/4ET



TM-USG-5/6ET  
Gracey  
Curette 5/6ET



TM-USG-7/8ET  
Gracey  
Curette 7/8ET



TM-USG-9/10ET  
Gracey  
Curette 9/10ET



TM-USG-11/12ET  
Gracey  
Curette 11/12ET



TM-USG-13/14ET  
Gracey  
Curette 13/14ET



TM-USG-15/16ET  
Gracey  
Curette 15/16ET

Scaler und Küretten  
Scalers and Curettes  
Scaler e Curette  
Raspadores y Curetas  
Détartreurs et Curettes



TM-USG-1/2  
Gracey  
Curette 1/2



TM-USG-3/4  
Gracey  
Curette 3/4



TM-USG-5/6  
Gracey  
Curette 5/6



TM-USG-7/8  
Gracey  
Curette 7/8



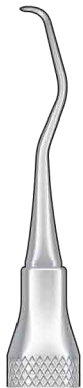
TM-USG-9/10  
Gracey  
Curette 9/10



TM-USG-11/12  
Gracey  
Curette 11/12



TM-USG-13/14  
Gracey  
Curette 13/14



TM-USG-1/2S  
Gracey  
Curette 1/2S



TM-USG-3/4S  
Gracey  
Curette 3/4S



TM-USG-5/6S  
Gracey  
Curette 5/6S



TM-USG-7/8S  
Gracey  
Curette 7/8S



TM-USG-9/10S  
Gracey  
Curette 9/10S



TM-USG-11/12S  
Gracey  
Curette 11/12S



TM-USG-13/14S  
Gracey  
Curette 13/14S



Hollow  
Hohl  
Creux  
Hueco  
Vuoto



Ø 9 mm

Scaler und Küretten  
Scalers and Curettes  
Scaler e Curette  
Raspadores y Curetas  
Détartreurs et Curettes



TM-USG-1/2L  
Gracey  
Curette 1/2L



TM-USG-3/4L  
Gracey  
Curette 3/4L



TM-USG-5/6L  
Gracey  
Curette 5/6L



TM-USG-7/8L  
Gracey  
Curette 7/8L



TM-USG-9/10L  
Gracey  
Curette 9/10L



TM-USG-11/12L  
Gracey  
Curette 11/12L



TM-USG-13/14L  
Gracey  
Curette 13/14L



TM-USG-15/16  
Gracey  
Curette 15/16



TM-USG-17/18S  
Gracey  
Curette 17/18S



TM-USS-KRA1  
Kramer  
Curette 1



TM-USS-KRA3  
Kramer  
Curette 3



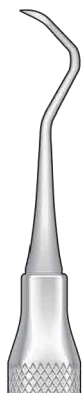
TM-USG-KN1/26  
Kramer-Nevis  
Chisels 1/2



TM-USS-MC11/12  
McCall  
Scaler 11/12



TM-USS-MC13/14  
McCall  
Curette 13/14



TM-USS-MC13/14S  
McCall  
Curette 13S/14S



TM-USS-MC17/18S  
McCall  
Curette 17S/18S



TM-USC-2RL  
Columbia  
Curette 2RL



TM-USC-4RL  
Columbia  
Curette 4RL



TM-USC-13/14  
Columbia  
Curette 13/14



TM-USS-5/6LAN  
Langer  
Curette 5/6



Scaler und K retten  
Scalers and Curettes  
Scaler e Curette  
Raspadores y Curetas  
D tarteurs et Curettes



Hollow  
Hohl  
Creux  
Hueco  
Vuoto



  9 mm



TM-USS-NV0  
Scaler  
Nv0



TM-USS-NV11/12  
Scaler  
NV11/12



TM-USS-NV13/14  
Scaler  
NV13/14



TM-USS-T2/3  
Taylor  
Scaler 2/3



TM-USS-204S  
Scaler  
204S



TM-USS-H6/7  
Towner  
Scaler  
H6/H7



TM-USS-15/33  
Towner  
Scaler  
U15/J33



TM-USS-5/33  
Towner  
Scaler  
H5/J33



TM-USS-15/30  
Towner  
Scaler  
U15/J30



TM-USS-J14/15  
Jaquette  
Scaler  
J14/15



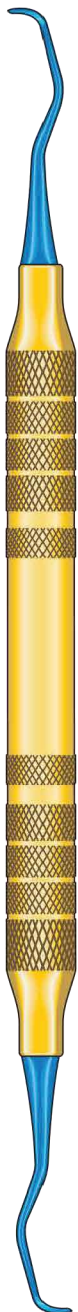


Hollow  
Hohl  
Creux  
Hueco  
Vuoto



Ø 9 mm

Designed for removing calculus on implants surfaces.  
Gold coloured handle with a titanium coating for easy identification purposes  
so they won't be mixed up with standard stainless instruments.



TM-T-USG-1/2  
Gracey  
Curette 1/2



TM-T-USG-5/6  
Gracey  
Curette 5/6



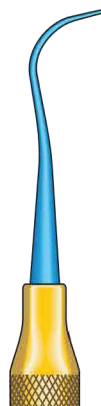
TM-T-USG-7/8  
Gracey  
Curette 7/8



TM-T-USG-11/12  
Gracey  
Curette 11/12



TM-T-USG-13/14  
Gracey  
Curette 13/14



TM-T-USS-YG7/8  
Younger-Good  
Curette YG 7/8

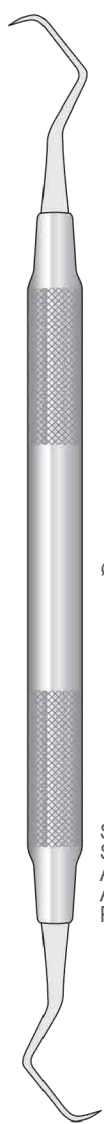


TM-T-USS-B5/6  
Barnhart  
Curette 5/6

Küretten - Feilen  
Curettes - Files  
Curette - Lime  
Curetasc - Lima  
Curettes - Limes

Universal Küretten  
Universal Curettes  
Curette universali  
Curetas universales  
Curettes universelles

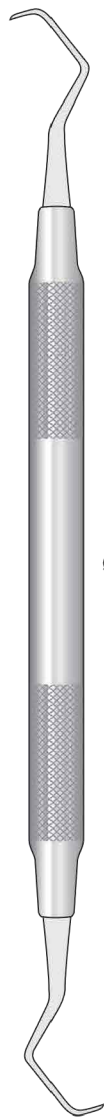
Parodontalfeilen  
Periodontal Files  
Lime parodontali  
Limas parodontales  
Limes parodontales



Ø 8.0 mm

Spitz  
Sharp  
Acuta  
Agudas  
Pointu

TM-718-M23  
165 mm



Ø 8.0 mm

Stumpf  
Blunt  
Smussa  
Romas  
Mousse

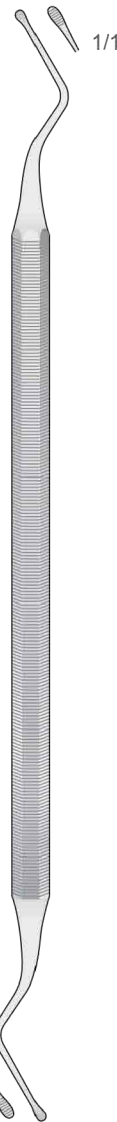
TM-718-M23A  
165 mm



Ø 8.0 mm

Spitz  
Sharp  
Acuta  
Agudas  
Pointu

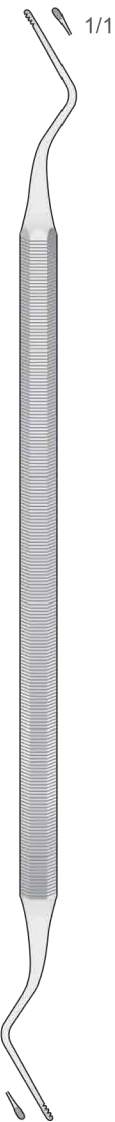
TM-718-M23B  
170 mm



1/1

1/1

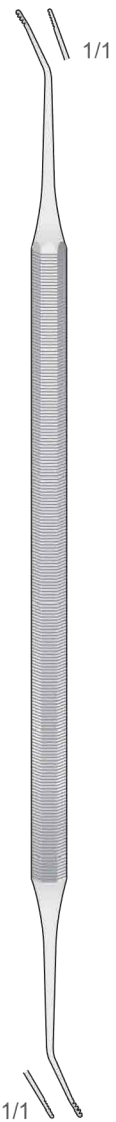
HIRSCHFELD  
TM-HF-3/7  
170 mm



1/1

1/1

HIRSCHFELD  
TM-HF-5/11  
170 mm

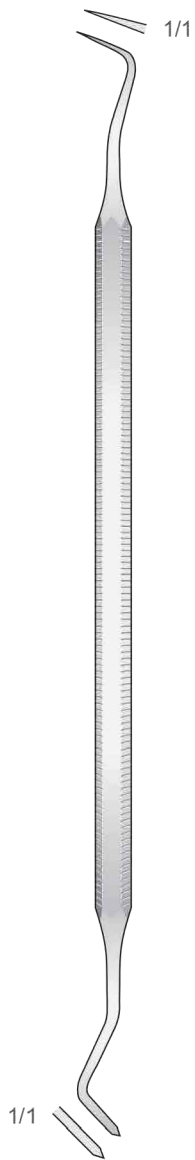


1/1

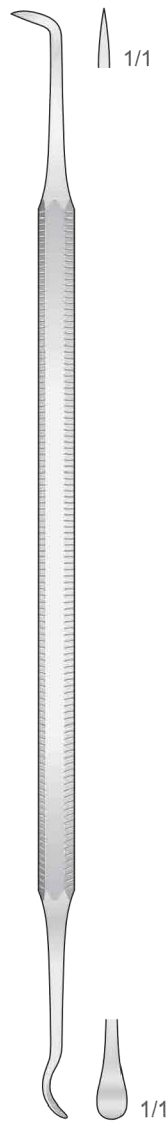
1/1

HIRSCHFELD  
TM-HF-9/10  
175 mm

Scalers



LANGE  
TM-PF-9  
160 mm



MITCHEL  
TM-AT-12  
170 mm



TM-AT-1



TM-AT-2R



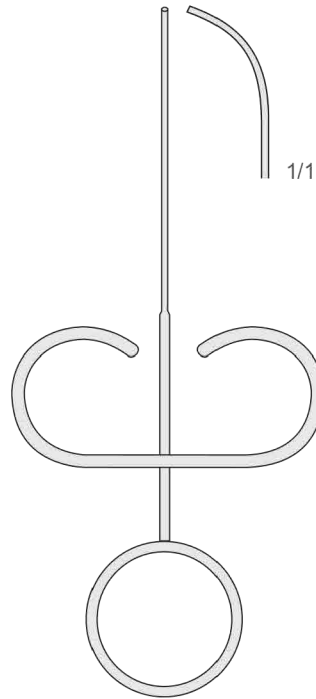
TM-AT-2L



TM-AT-6

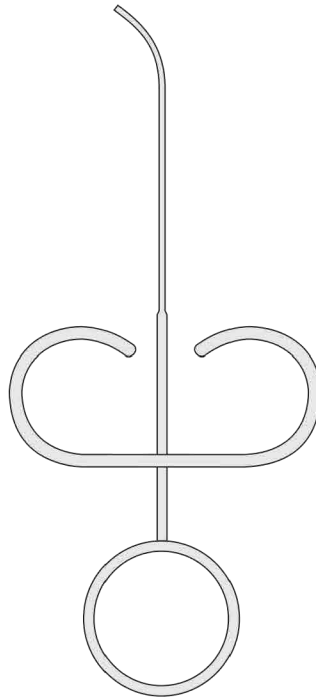
Amalgampistole für retrograde  
Amalgam gun for retrograde  
Siringhe portamalgame retrogradi  
Portaamalgama para retrógradas  
Porte-amalgame pour rétrogrades

Nach oben Gebogen - Curved up  
Curva in avanti - Curvas hacia arriba  
Courbes vers le haut  
Ø 0,9 mm



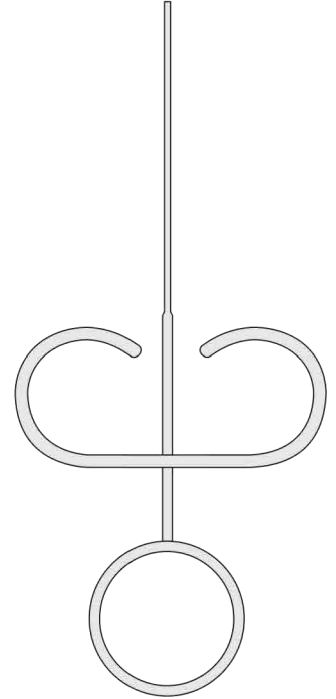
TM-SS-51  
130 mm

Seitwärts Gebogen - Curved to side  
Curva sul lato - Curvas laterales  
Courbes latérales  
Ø 0,9 mm



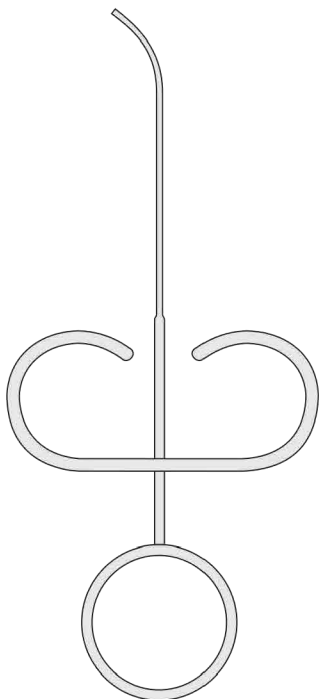
TM-SS-55  
130 mm

Gerade - Straight  
Diritta - Rectas  
Droites  
Ø 1,2 mm



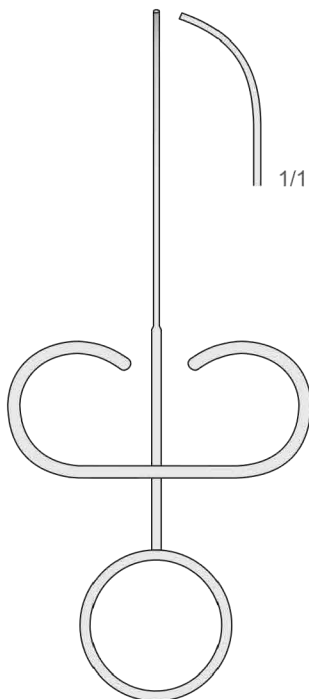
TM-SS-54  
130 mm

Seitwärts Gebogen - Curved to side  
Curva sul lato - Curvas laterales  
Courbes latérales  
Ø 1,2 mm



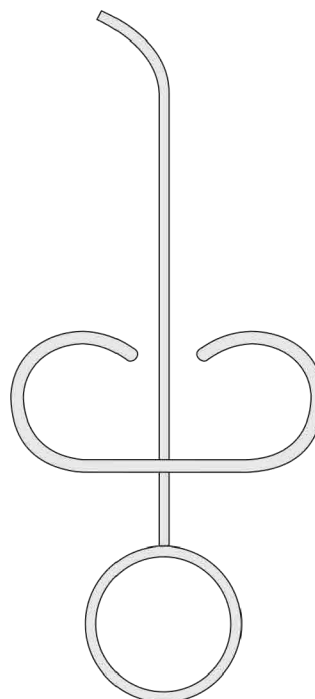
TM-SS-56  
130 mm

Nach oben Gebogen - Curved up  
Curva in avanti - Curva hacia arriba  
Courbes vers le haut  
Ø 1,2 mm



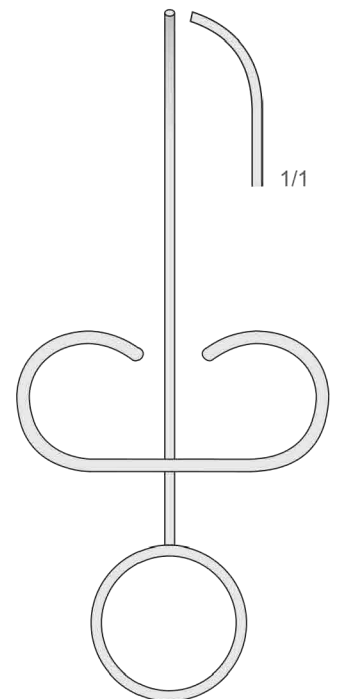
TM-SS-58  
130 mm

Seitwärts Gebogen - Curved to side  
Curva sul lato - Curvas laterales  
Courbes latérales  
Ø 1,8 mm



TM-SS-50  
130 mm

Nach oben Gebogen - Curved up  
Curva in avanti - Curvas hacia arriba  
Courbes vers le haut  
Ø 1,8 mm



TM-SS-52  
130 mm

Amalgambecher  
Amalgam Well  
Mortajo per amalgama  
Vaso para amalgama  
Gobelet pour amalgame



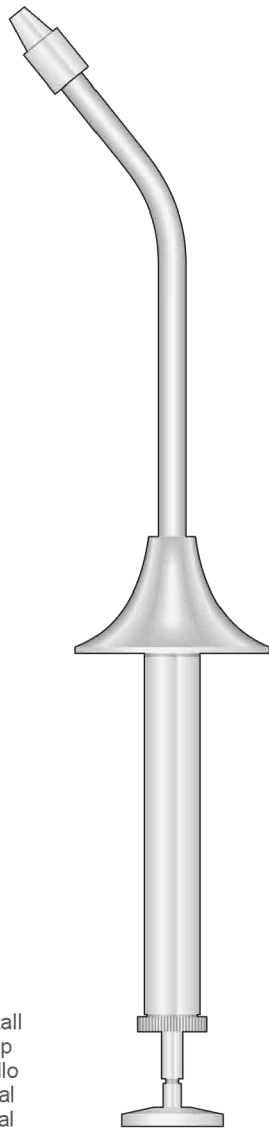
TM-SS-65  
Ø 35 mm  
h. 35 mm

Amalgamträger  
Amalgam Carriers  
Porta amalgama  
Porta-amalgamas  
Porte-amalgames

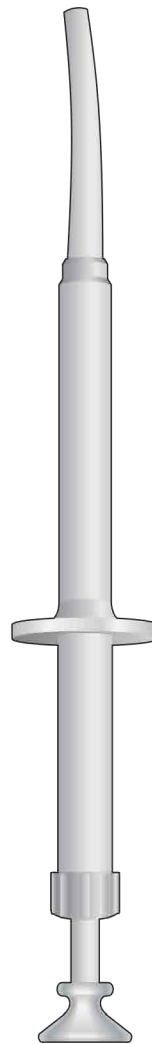


TM-SS-15

Aus Metall  
Metal tip  
In metallo  
De metal  
En métal

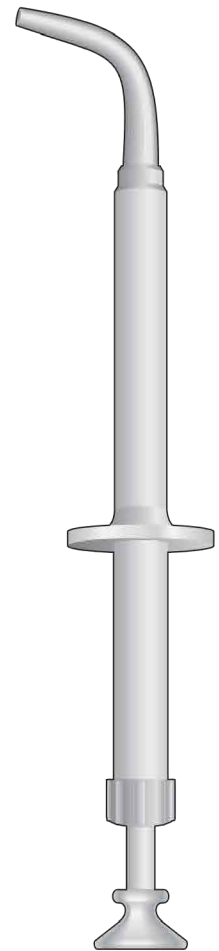


TM-SS-16



TM-SS-41  
170 mm

Autoclavable  
Aus Kunststoff  
Plastic tip  
In plastica  
De plàstico  
En plastique



TM-SS-42  
160 mm

Kompositinstrumente  
Composite Instruments  
Strumenti per composito  
Instrumentos para composites  
Instruments pour composites

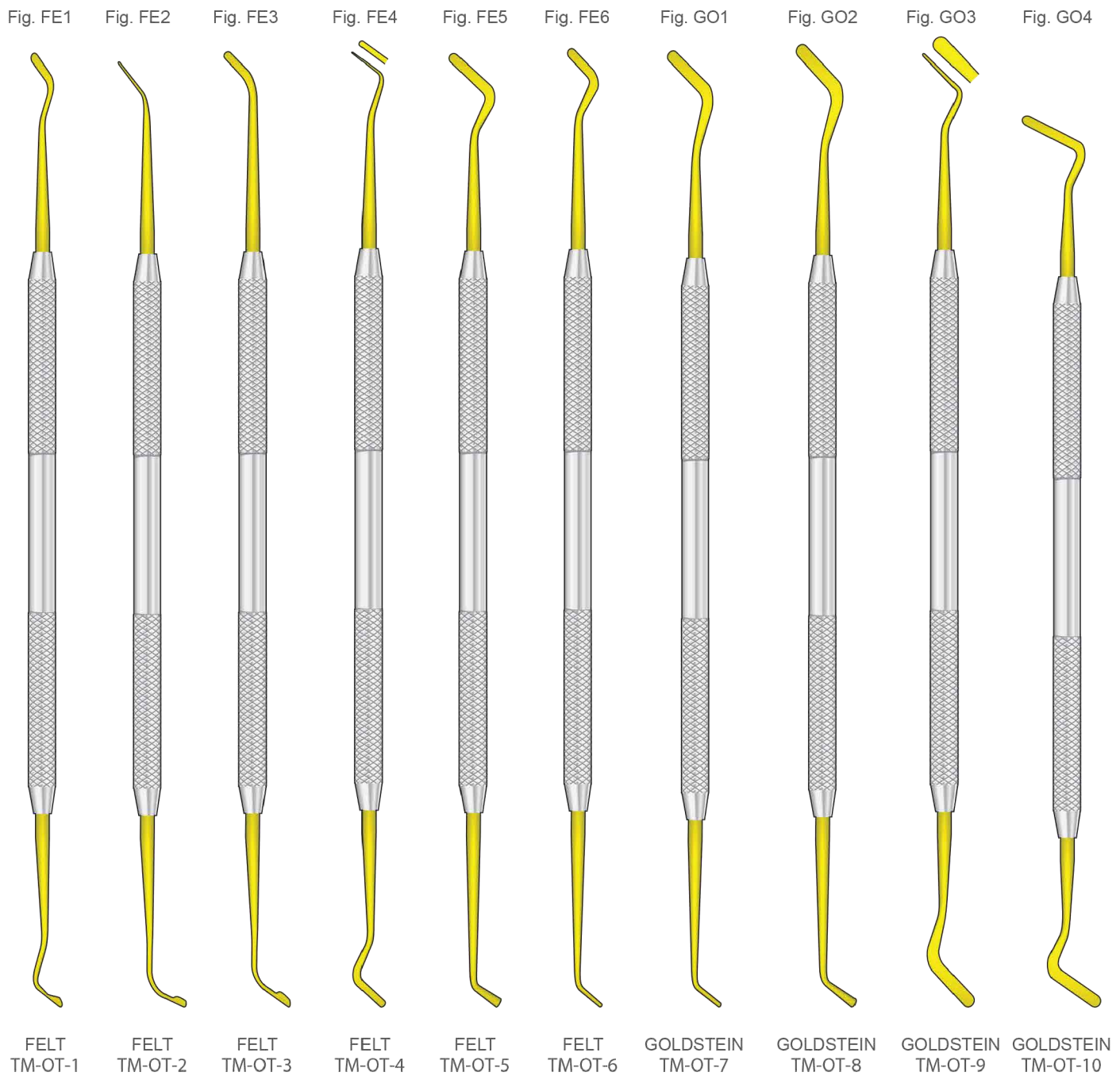




Fig. CP1  
1,5 mm



TM-OT-11

Fig. CP2  
2,0 mm



TM-OT-12

Fig. CP3  
2,0 mm



TM-OT-13

Fig. CP4  
2,5 mm



TM-OT-14

Fig. CP5



TM-OT-15

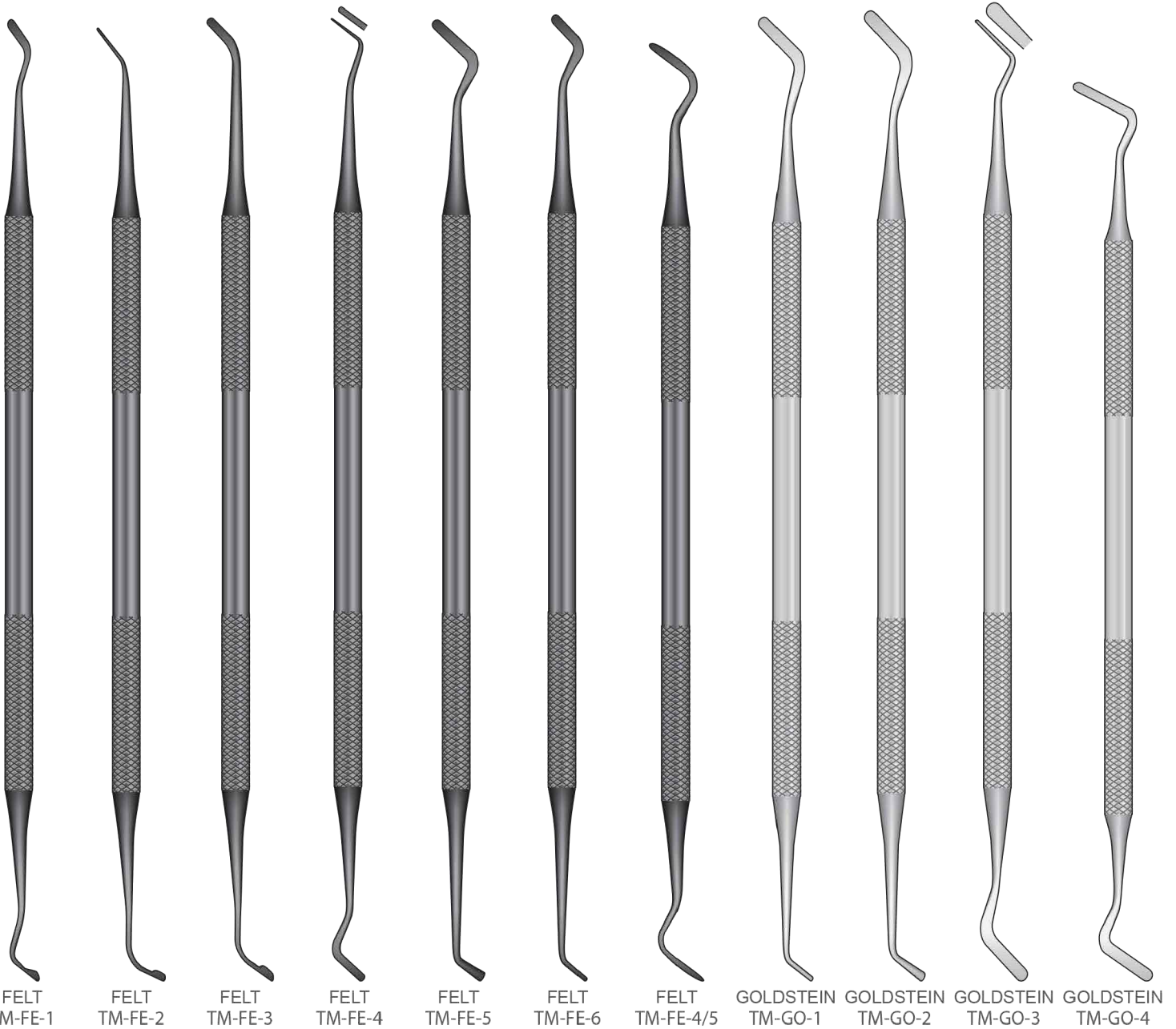
Fig. CP6



TM-OT-16



Kompositinstrumente  
Composite Instruments  
Strumenti per composito  
Instrumentos para composites  
Instruments pour composites



FELT TM-FE-1 FELT TM-FE-2 FELT TM-FE-3 FELT TM-FE-4 FELT TM-FE-5 FELT TM-FE-6 FELT TM-FE-4/5 GOLDSTEIN TM-GO-1 GOLDSTEIN TM-GO-2 GOLDSTEIN TM-GO-3 GOLDSTEIN TM-GO-4

Zementspatel  
Cement Spatulas  
Spatole per cemento  
Espátulas para cemento  
Spatules à ciment



TM-SR  
140 mm



TM-S-00  
180 mm



TM-S-0  
185 mm



TM-S-1  
180 mm



TM-S-2  
180 mm



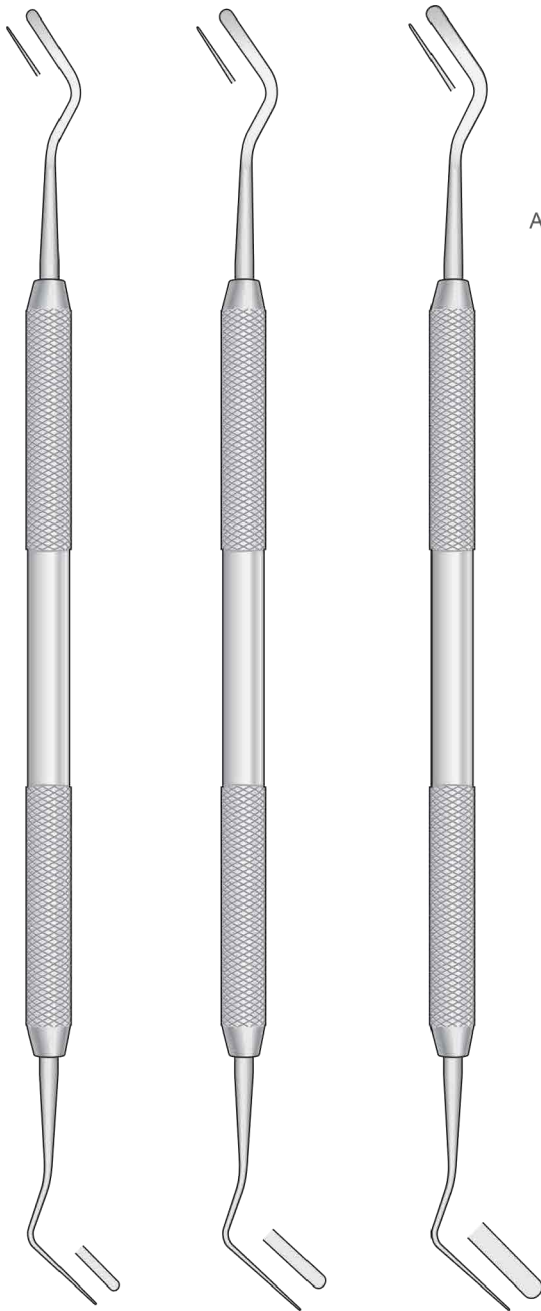
TM-S-3  
180 mm



TM-S-4  
20 mm

Füllungsinstrumente  
Filling Instruments  
Strumenti per otturazione  
Instrumentos para obturación  
Instruments pour obturation

Heidemann-Spateln  
Heidemann Spatulas  
Spatole Heidemann  
Espátulas Heidemann  
Spatules Heidemann



TM-H-1  
Fig. 1

TM-H-2  
Fig. 2

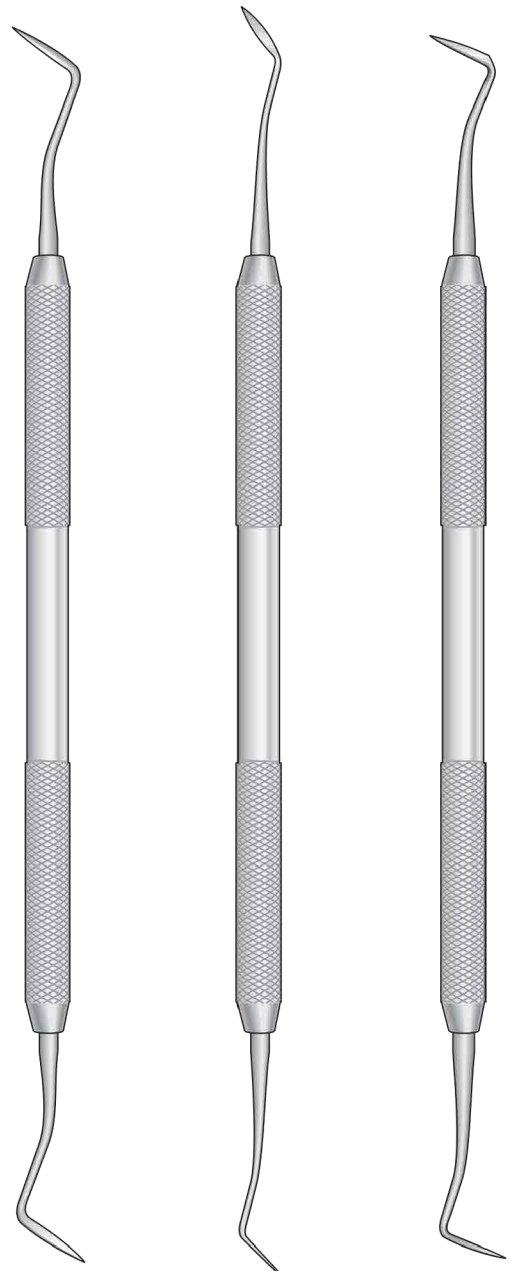
TM-H-3  
Fig. 3

Dycal Applikator  
Placement Instrument  
Aplicatore per sottofondo  
Aplicadores de fondo  
de cavidades  
Applicateur de fond  
de cavité



TM-A-1  
125 mm

Amalgam Instrumente  
Amalgam Carvers  
Strumenti per modellare l'amalgama  
Instrumentos para modelar las obturaciones  
Instruments à modeler l'amalgame



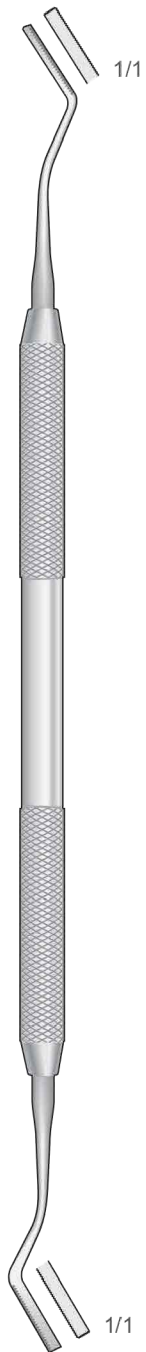
TM-R-1  
HOLLENBACH  
# 1 - 165 mm

TM-R-2  
HOLLENBACH  
# 1/2 - 165 mm

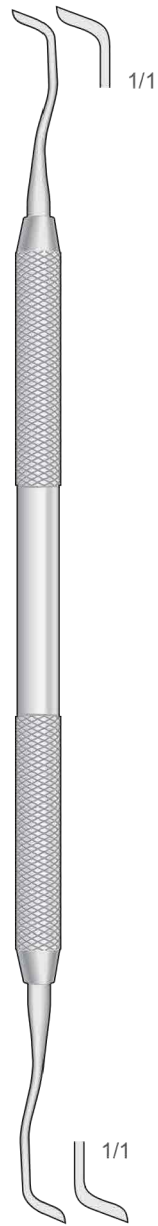
TM-R-3  
HOLLENBACH  
# 3 - 165 mm

Instrument für Drahrückzug  
Instrument for retractor wire  
Strumento per filo retrattore  
Instrumento para hilo separador  
Instruments pour fil séparateur

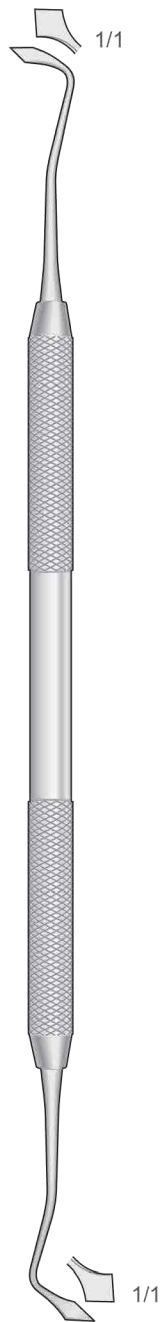
Cleoids - Discoids



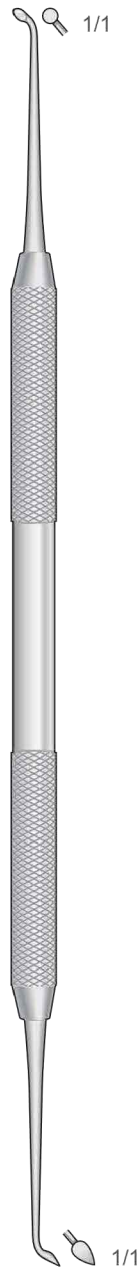
TM-CV-11



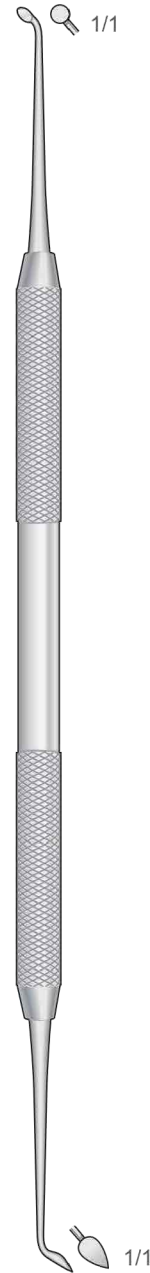
TM-TM-USC-2  
USC



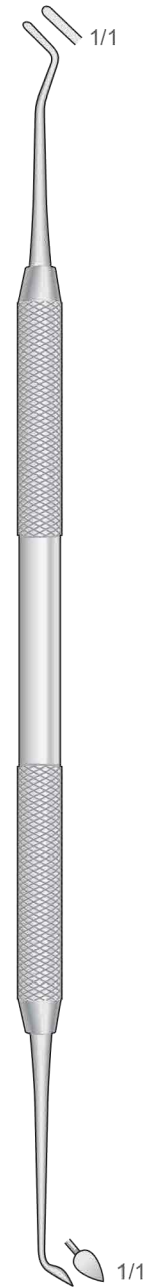
TM-F-2/3  
FRAHM



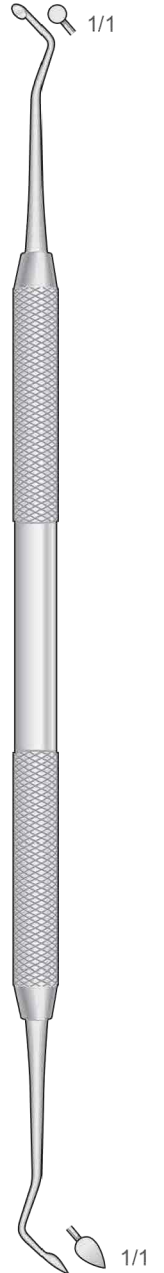
TM-CD-1V  
Fig. 1/2



TM-CD-2  
Fig. 4/5

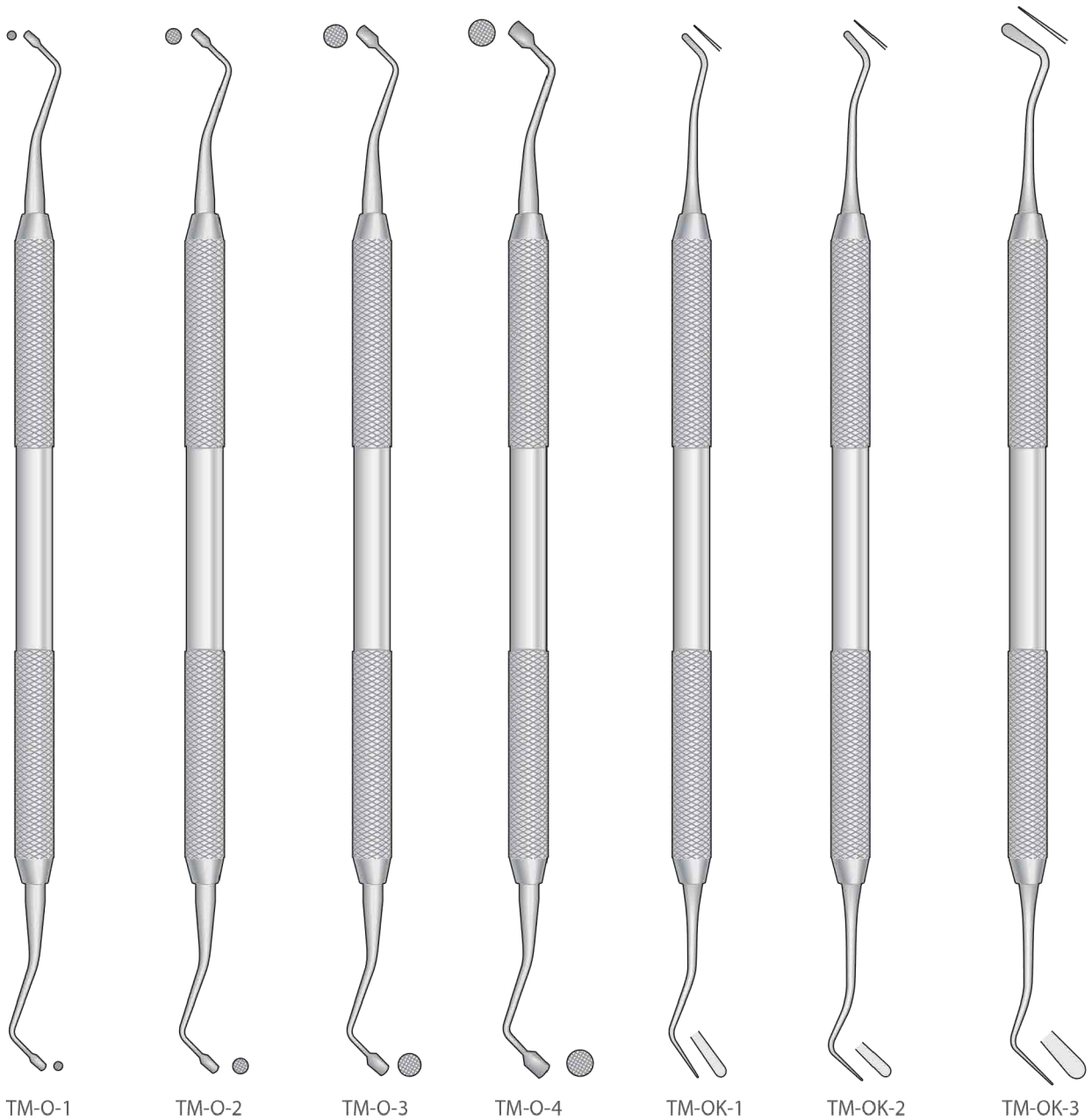


TM-CD-3  
Fig. W.A.C.D.



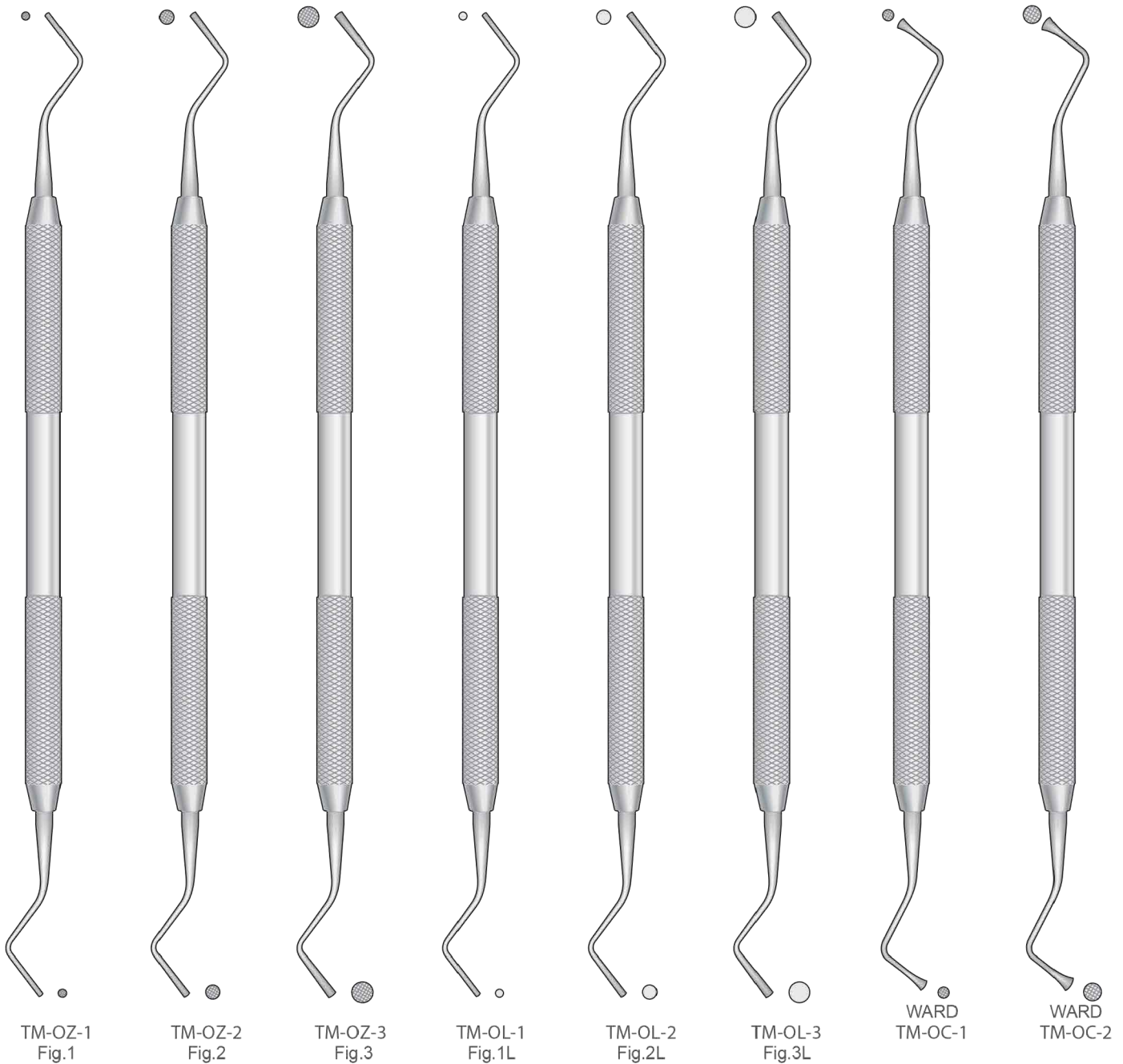
TM-CD-4  
Fig. 3/6

Füllungsinstrumente  
Filling Instruments  
Strumenti per otturazione  
Instrumentos para obturación  
Instruments pour obturation



Gerieft  
Serrated  
Zigrinati  
Estridados  
Striée

Glatt  
Smooth  
Lisci  
Lisos  
Lissée



TM-OZ-1  
Fig.1

TM-OZ-2  
Fig.2

TM-OZ-3  
Fig.3

TM-OL-1  
Fig.1L

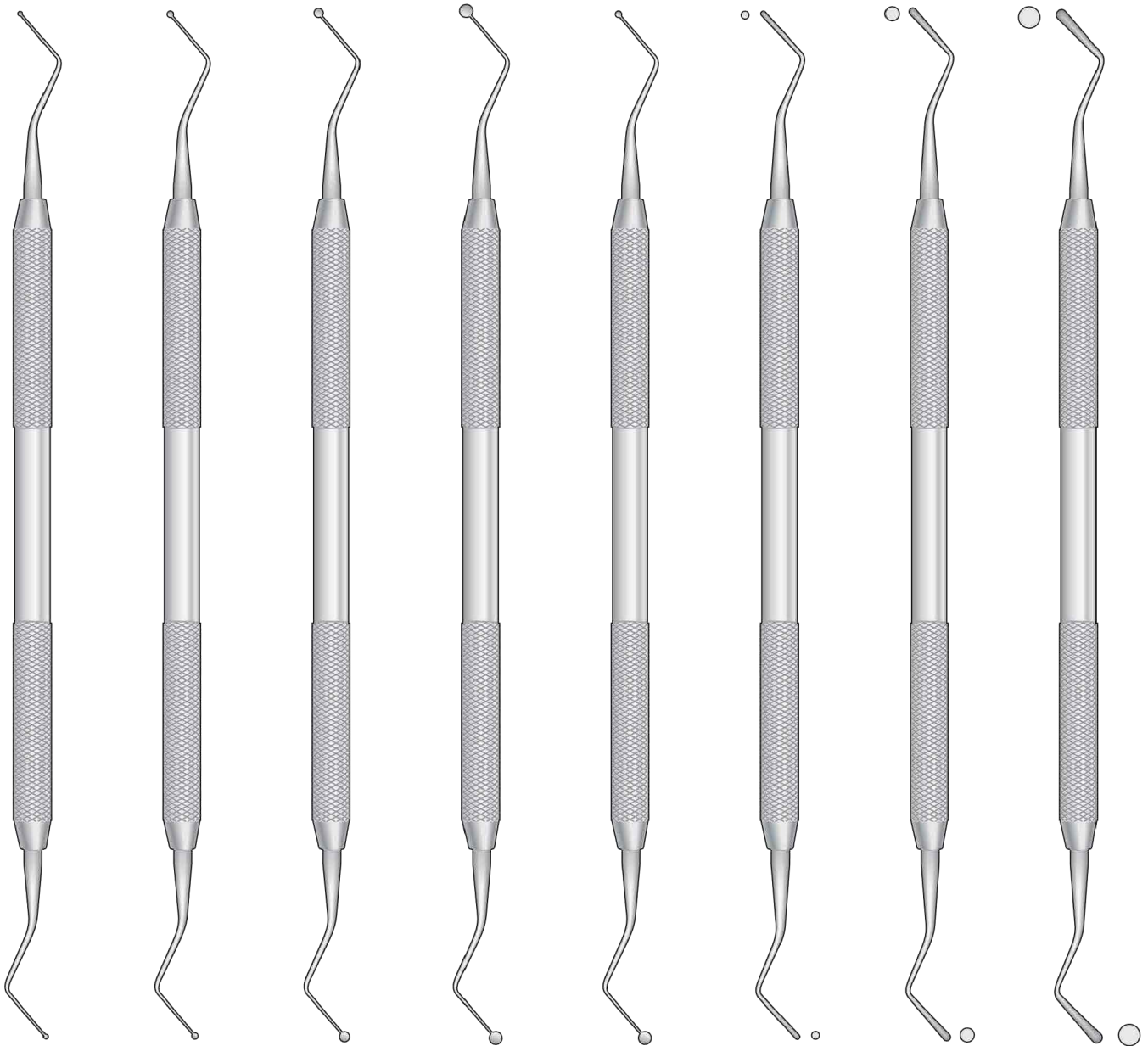
TM-OL-2  
Fig.2L

TM-OL-3  
Fig.3L

WARD  
TM-OC-1

WARD  
TM-OC-2

Füllungsinstrumente  
Filling Instruments  
Strumenti per otturazione  
Instrumentos para obturación  
Instruments pour obturation



TM-OP-1  
Fig.1

TM-OP-2  
Fig.2

TM-OP-3  
Fig.3

TM-OP-4  
Fig.4

TM-OP-5  
Fig.5

TM-OA-1  
Fig.1

TM-OA-2  
Fig.2

TM-OA-3  
Fig.3



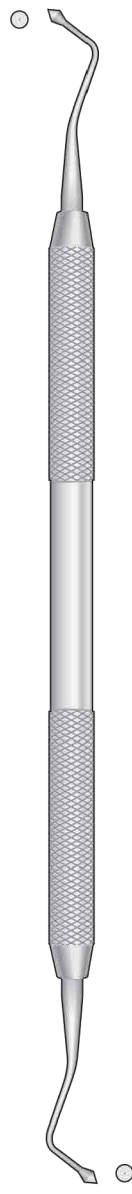
TM-OX-1



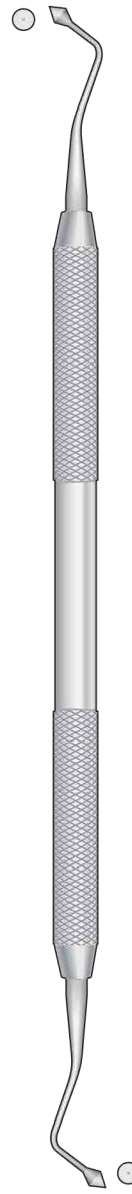
TM-OX-2



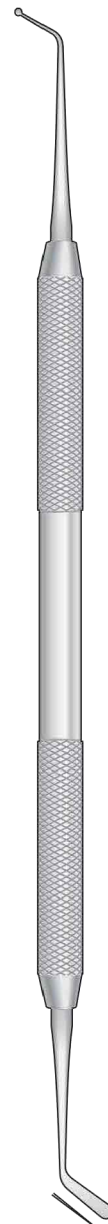
TM-OX-3



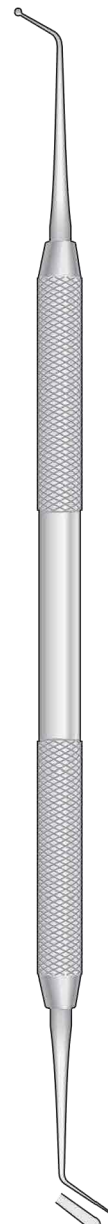
WESTCOTT  
TM-OS-1



WESTCOTT  
TM-OS-2



TM-OM-2



TM-ON-1



Restaurative Zahnheilkunde  
Dental Restoration  
Odontoiatria conservativa  
Odontología conservadora  
Odontologie conservatrice

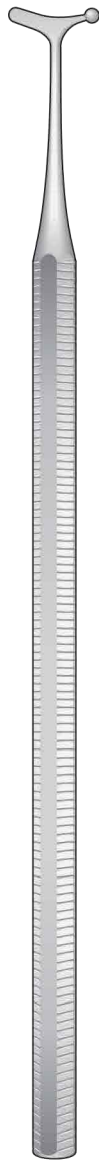
Füllungsinstrumente  
Filling Instruments  
Strumenti per otturazione  
Instrumentos para obturación  
Instruments pour obturation



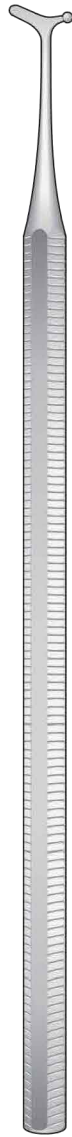
WHITE  
TM-B-3  
n°28



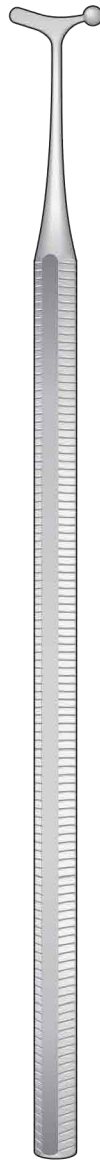
WHITE  
TM-B-4  
n°29



WHITE  
TM-B-32  
n°32



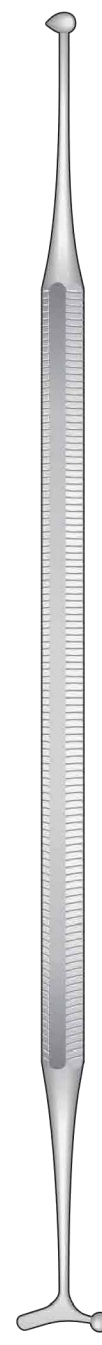
WHITE  
TM-B-33  
n°33



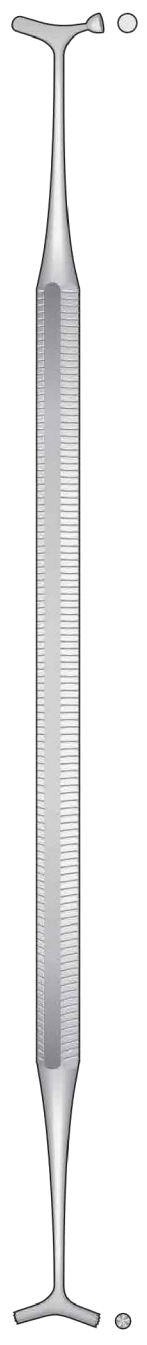
WHITE  
TM-B-34  
n°34



WHITE  
TM-B-28/29  
Doppio



WHITE  
TM-B-31/32  
Doppio

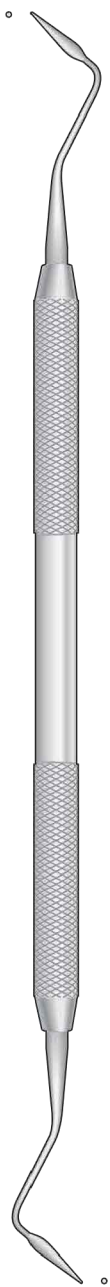


BENNET  
TM-B-35  
170 mm

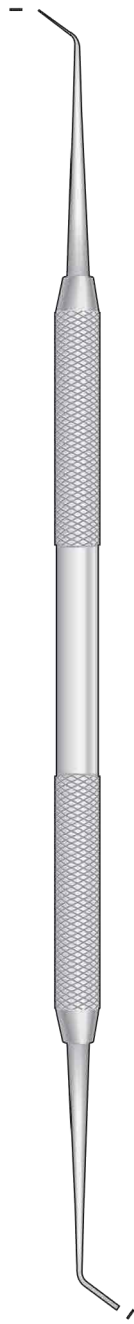
MARKLEY PLUGGERS  
Amalgam Instrumente  
Amalgam Instruments  
Strumenti per amalgama  
Instrumentos para amalgama  
Instruments à amalgame



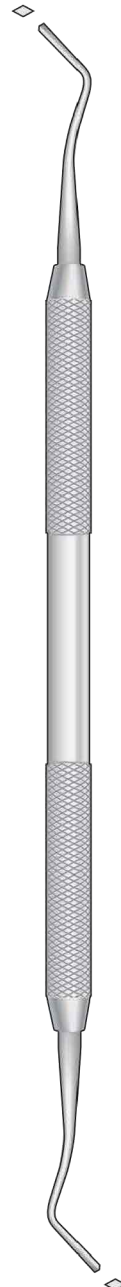
TM-PM-1  
Fig.1M



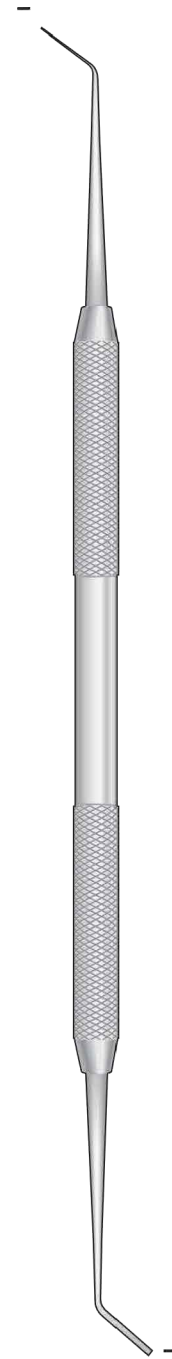
TM-PM-2  
Fig.2M



TM-PM-3  
Fig.3M



TM-PM-4  
Fig.4M

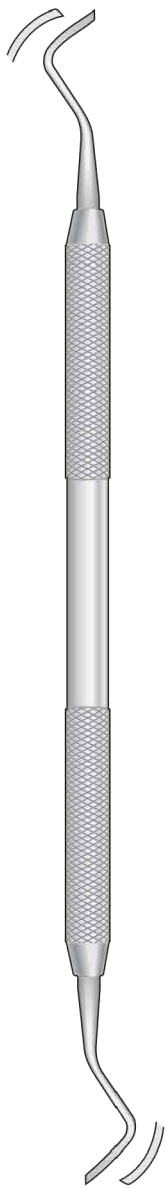


TM-PM-5  
Fig.5M

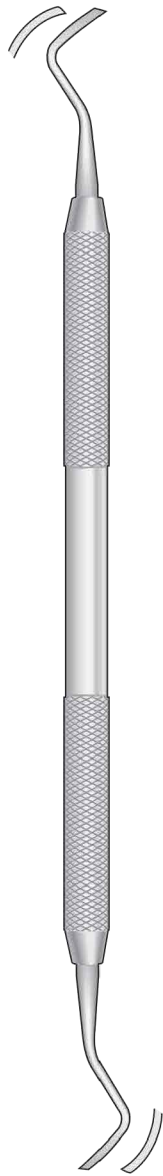


TM-PM-6  
Fig.6M

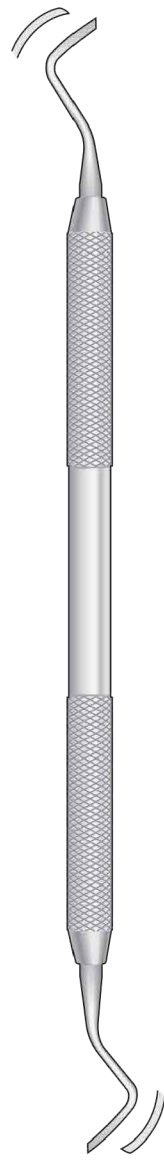
Schmelzinstrumente  
Enamel Instruments  
Strumenti da smalto  
Instrumentos para esmalte  
Instruments à émail



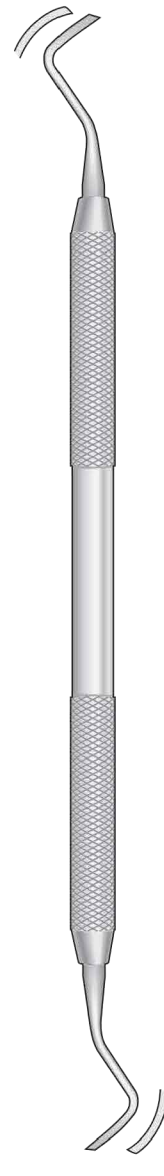
BLACK  
TM-TS-1  
Fig.26



BLACK  
TM-TS-2  
Fig.27



BLACK  
TM-TS-3  
Fig.28



BLACK  
TM-TS-4  
Fig.29



TM-E-0  
Fig.0



TM-E-1  
Fig.1



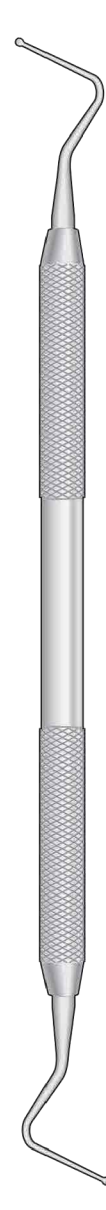
TM-E-2  
Fig.2



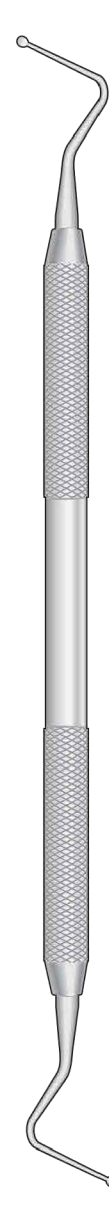
TM-E-3  
Fig.3



TM-E-4  
Fig.4



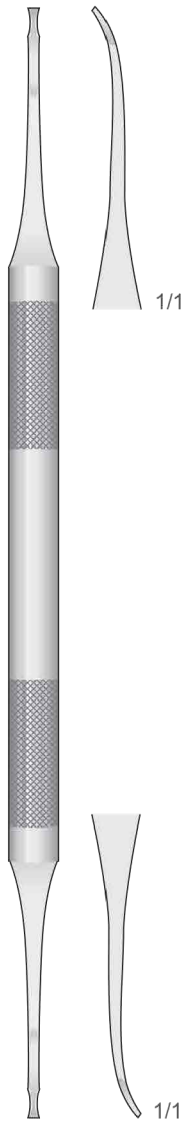
TM-EC-1  
Fig.1



TM-EC-2  
Fig.2

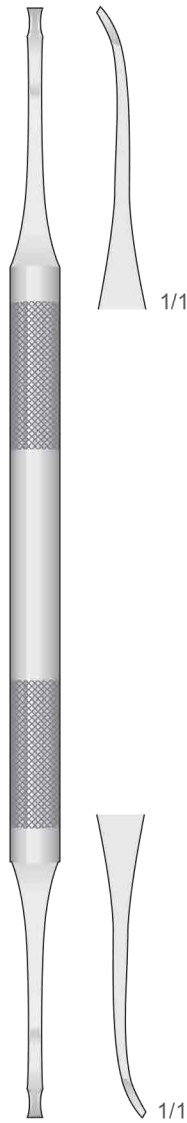
Meißel für Parodontologie  
Periodontal Chisels  
ScalPELLI parodontali  
Cinceles periodontales  
Burins parodontaux

Fig. 1



FEDI  
TM-OF-1  
175 mm

Fig. 2



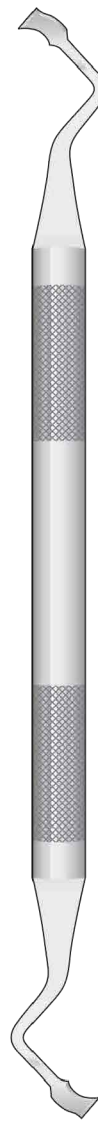
FEDI  
TM-OF-2  
175 mm

Fig. 3



FEDI  
TM-OF-3  
170 mm

Fig. 4



OCHSENBEIN  
TM-OSB-4A  
170 mm



TM-OSB-4  
170 mm

Bevel IN  
Fig.1



OCHSENBEIN-1  
TM-OSB-1  
165 mm

Bevel OUT  
Fig.2



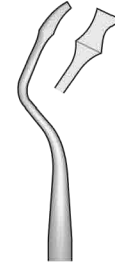
OCHSENBEIN-2  
TM-OSB-2  
165 mm



TG CHISELS  
TM-718-113



OCHSENBEIN-3  
TM-718-103



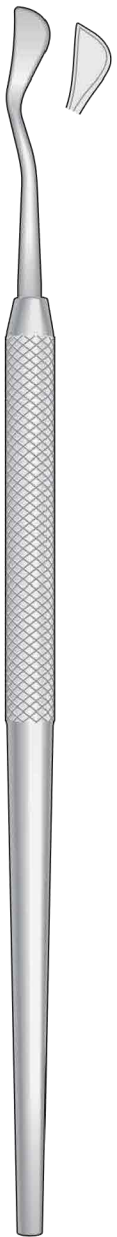
OCHSENBEIN-4  
TM-718-104



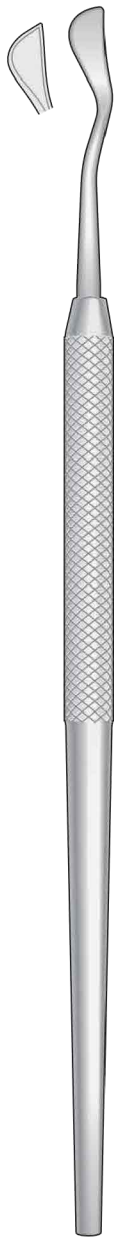
RHODES BACK ACTION  
TM-718-107



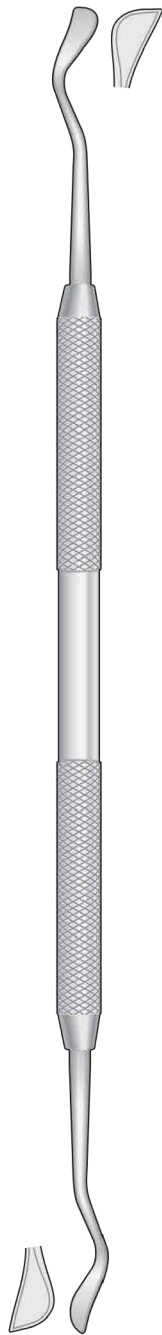
Parodontalmesser  
Gingivectomy Knives  
Bisturi per gengivectomia  
Bisturís para la gengivectomía  
Bistouris pour la gengivectomie



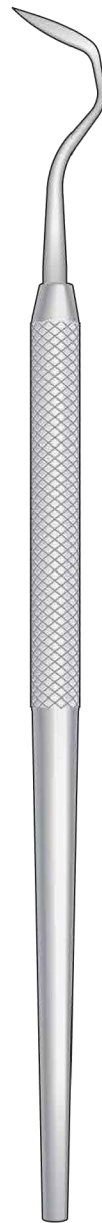
KIRKLAND  
TM-KKD-1  
Fig. 15K



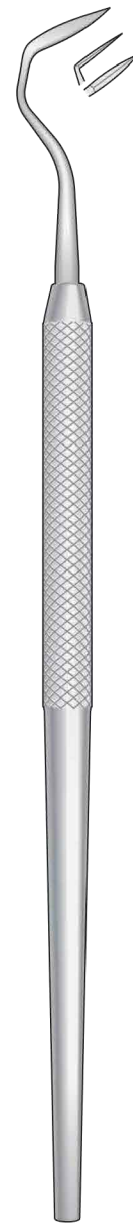
KIRKLAND  
TM-KKD-2  
Fig. 16K



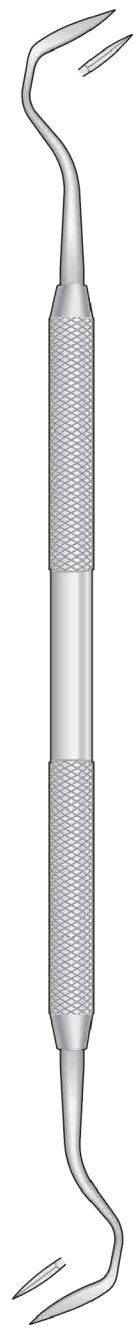
KIRKLAND  
TM-KKD-4  
Fig. 15K - Fig. 16K



ORBAN  
TM-OBN-1  
Fig. 1



ORBAN  
TM-OBN-2  
Fig. 2



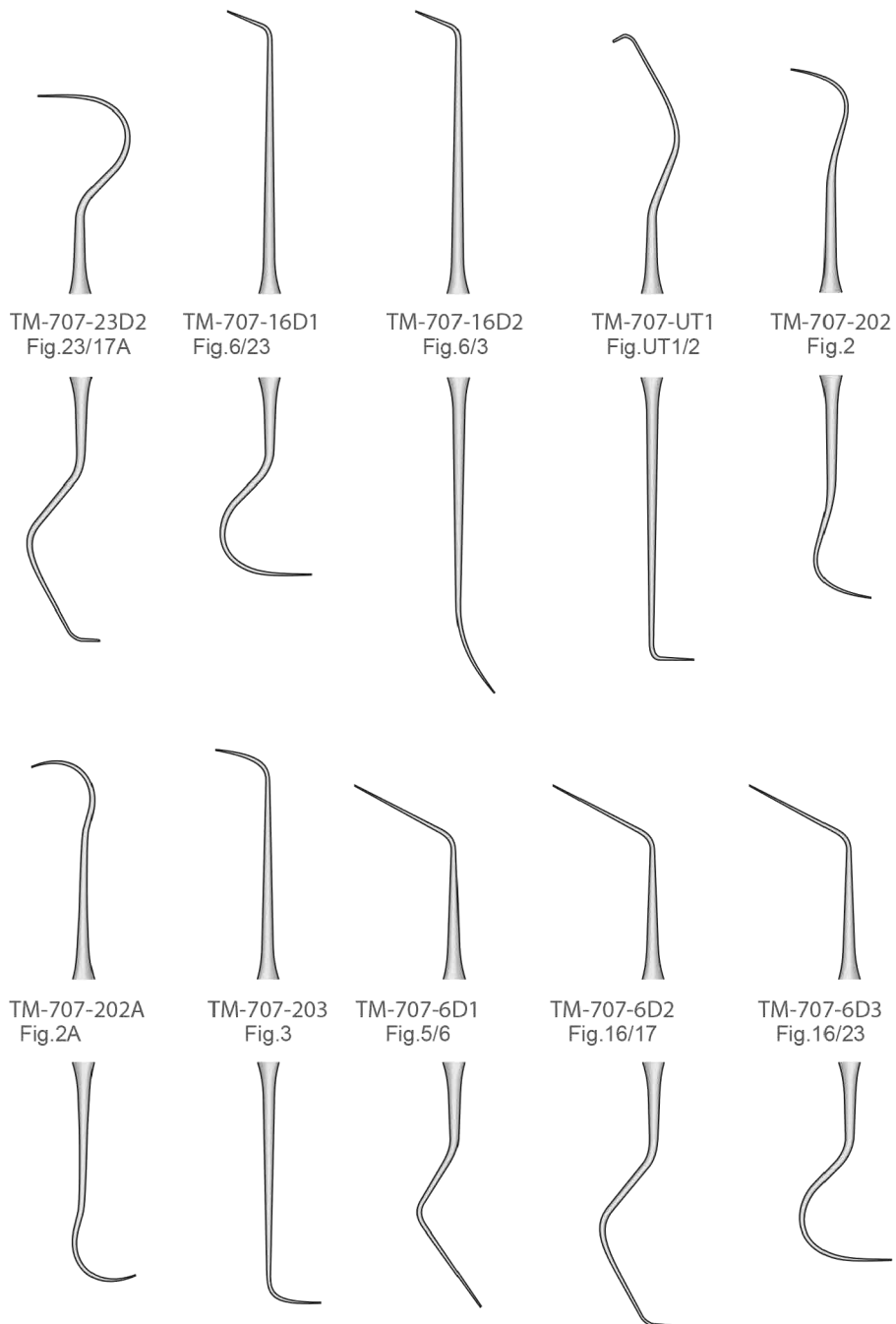
ORBAN  
TM-OBN-4  
Fig. 1 - Fig. 2

Doppelendiger Zahnsonden  
Double-ended Explorer  
Sonda falce doppia  
Sonda exploradora doble  
Sonde exploratrice double



Ø 8 mm  
**Hollow**  
Hohl  
Creux  
Hueco  
Vuoto

TM-707-23D1  
Fig.23/17



TM-707-23D2  
Fig.23/17A

TM-707-16D1  
Fig.6/23

TM-707-16D2  
Fig.6/3

TM-707-UT1  
Fig.UT1/2

TM-707-202  
Fig.2

TM-707-202A  
Fig.2A

TM-707-203  
Fig.3

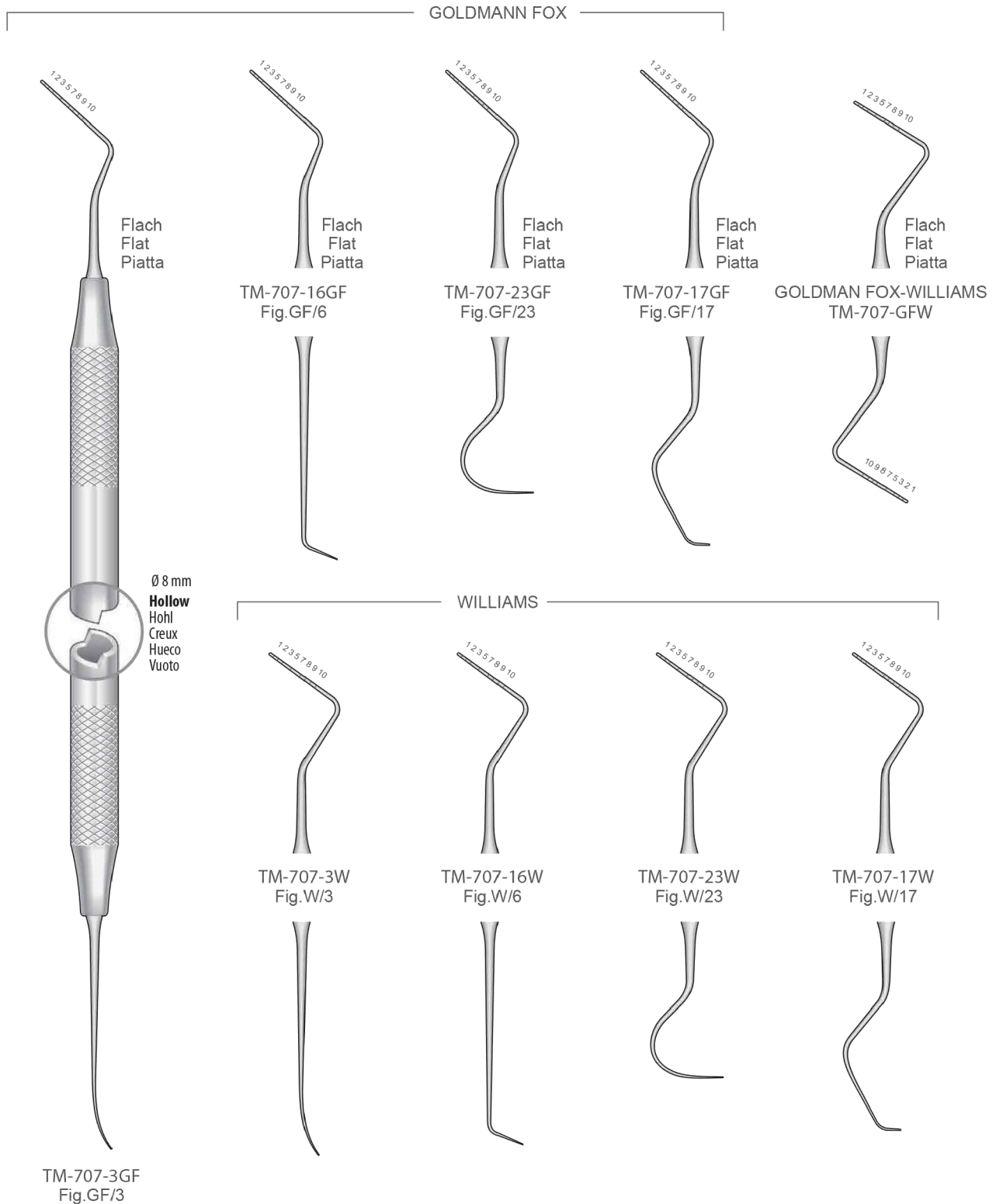
TM-707-6D1  
Fig.5/6

TM-707-6D2  
Fig.16/17

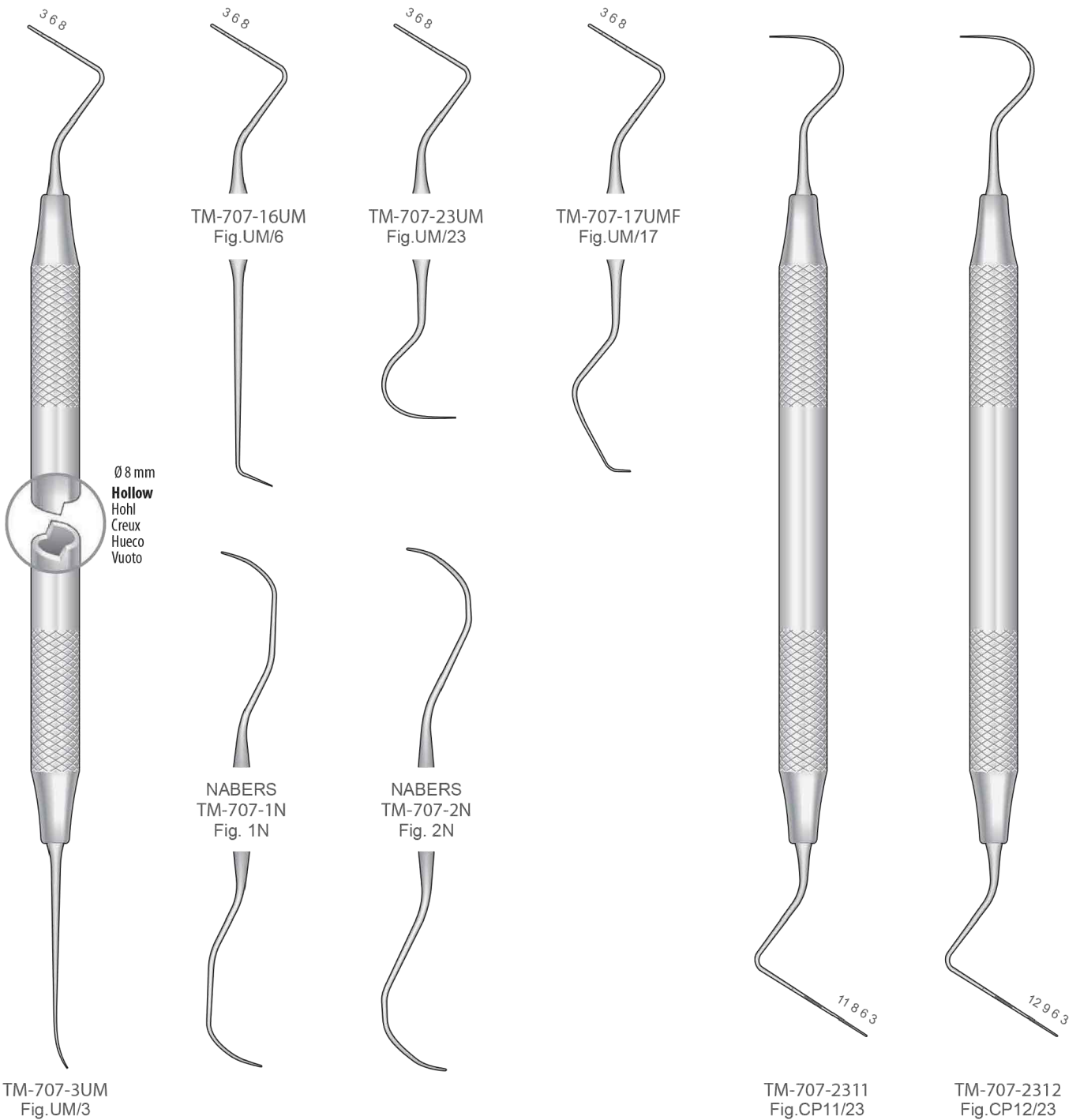
TM-707-6D3  
Fig.16/23



Doppelendiger Parodontometer  
 Double-ended Periodontal Probes  
 Sondes parodontales doubles  
 Sonde parodontali doppie  
 Sondas parodontales doubles

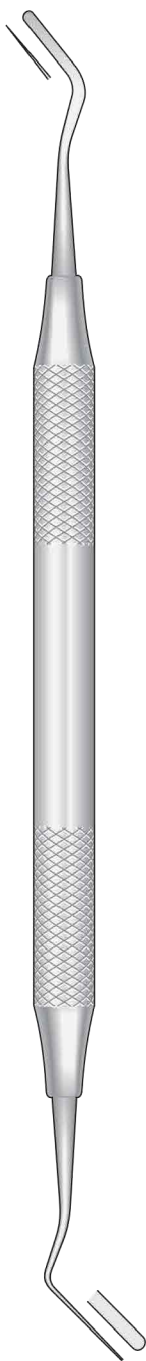


UNIVERSITY OF MICHIGAN

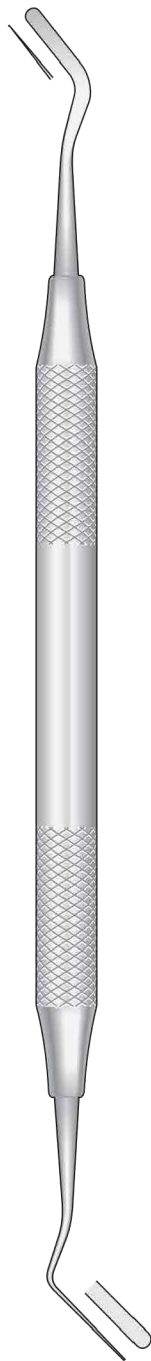


Spateln - Füllungsinstrumente  
 Spatulas - Filling Instruments  
 Spatole - Strumenti per otturazione  
 Espátulas - Instrumentos para obturación  
 Spatules - Instruments pour obturation

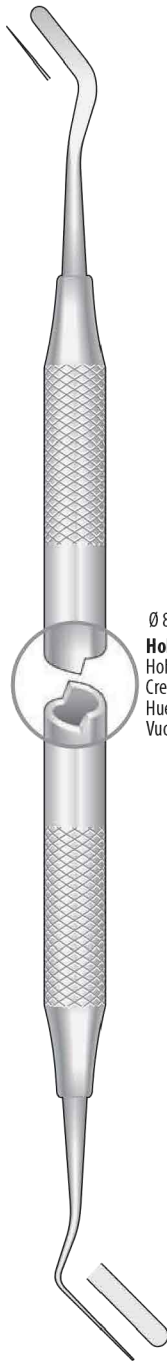
Heidemann Spateln  
 Heidemann Spatulas  
 Spatole Heidemann  
 Espátulas Heidemann  
 Spatules Heidemann



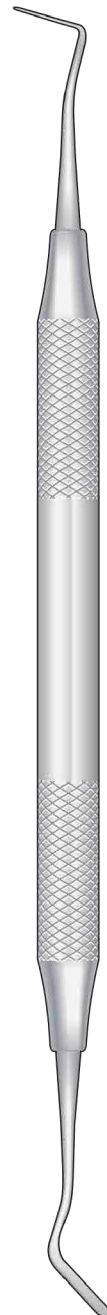
HEIDEMANN  
 TM-711-301  
 Fig.1



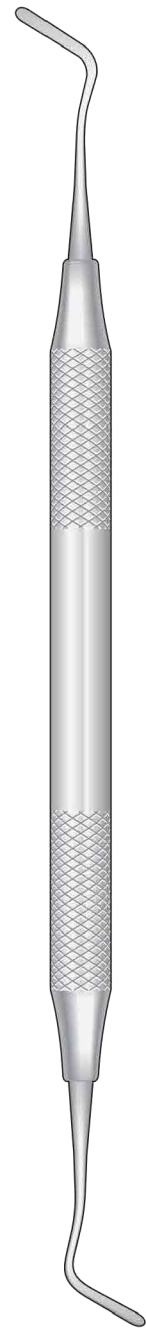
HEIDEMANN  
 TM-711-302  
 Fig.2



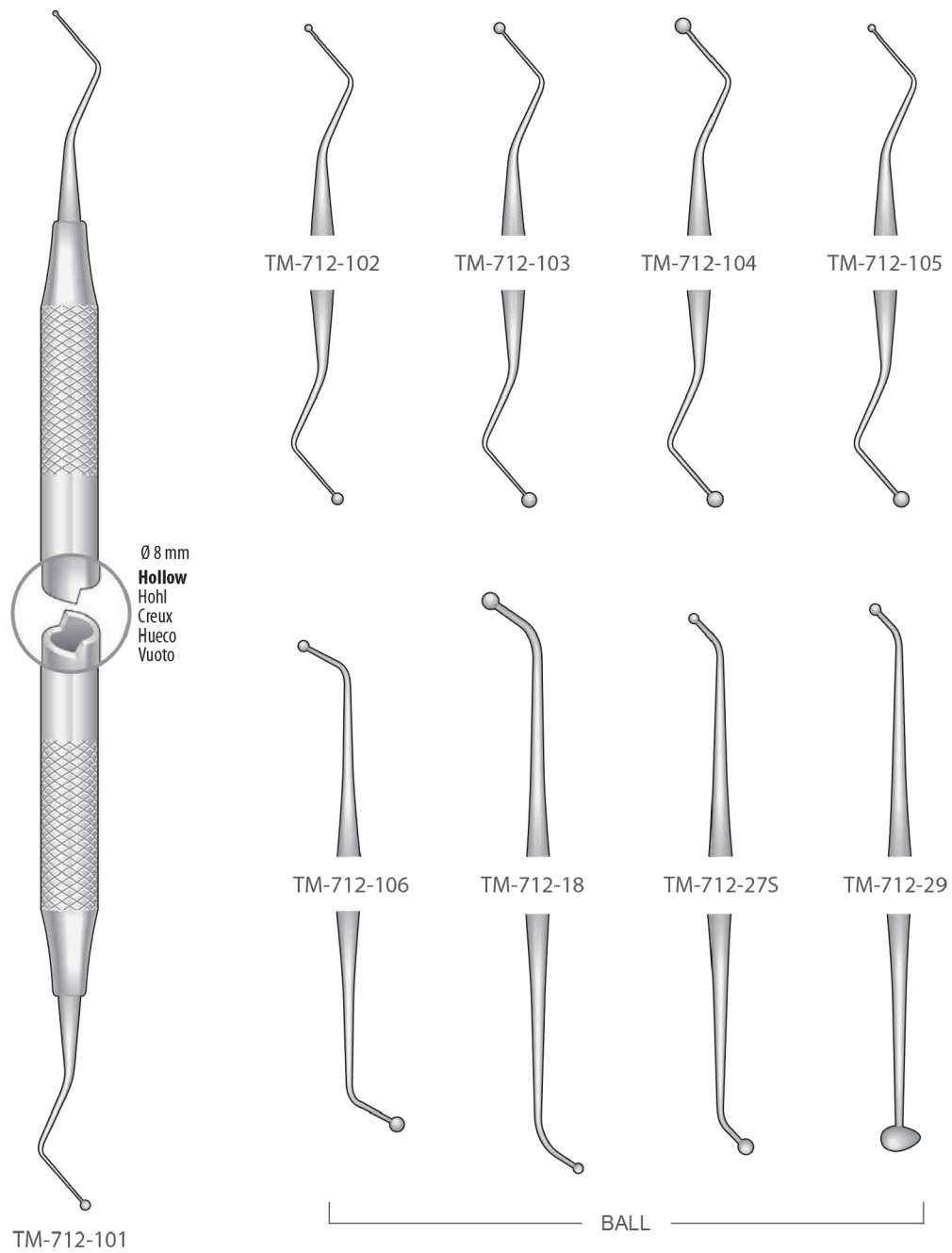
HEIDEMANN  
 TM-711-303  
 Fig.3



IPC Fig. 1  
 TM-715-311  
 Interproximal

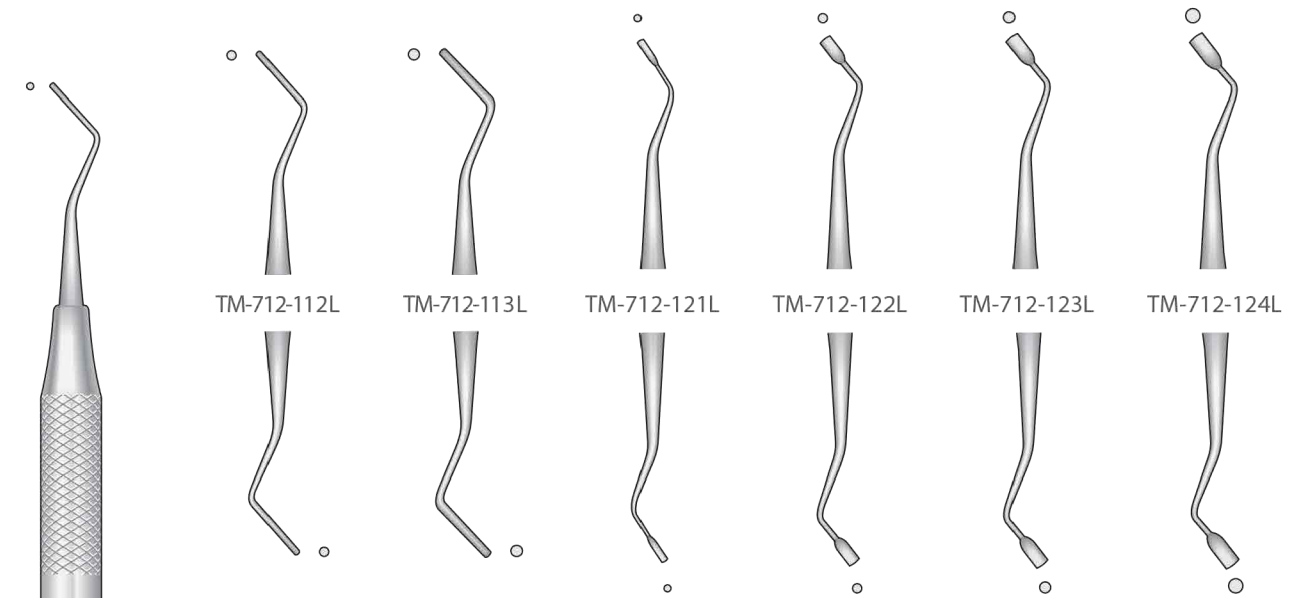


IPC/OA Fig. 2  
 TM-715-312  
 Interproximal Off-Angle



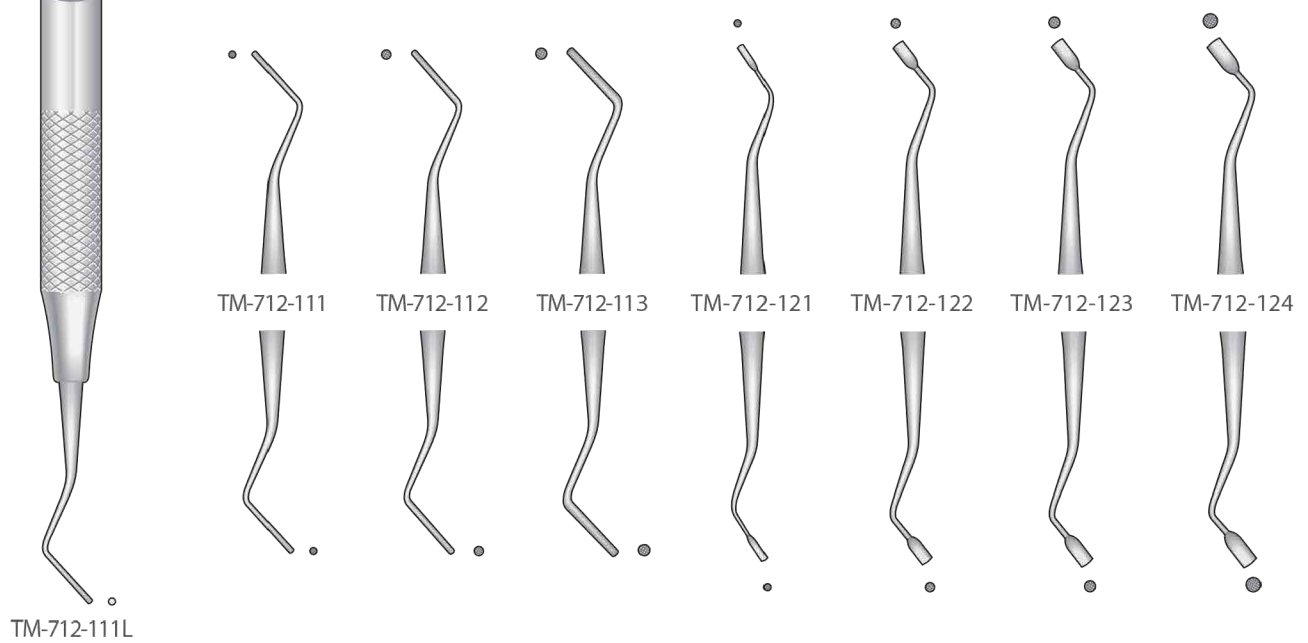
Füllungsinstrumente  
Filling Instruments  
Strumenti per otturazione  
Instrumentos para obturación  
Instruments pour obturation

Glatt - Smooth  
Lisci - Lisos  
Lissée

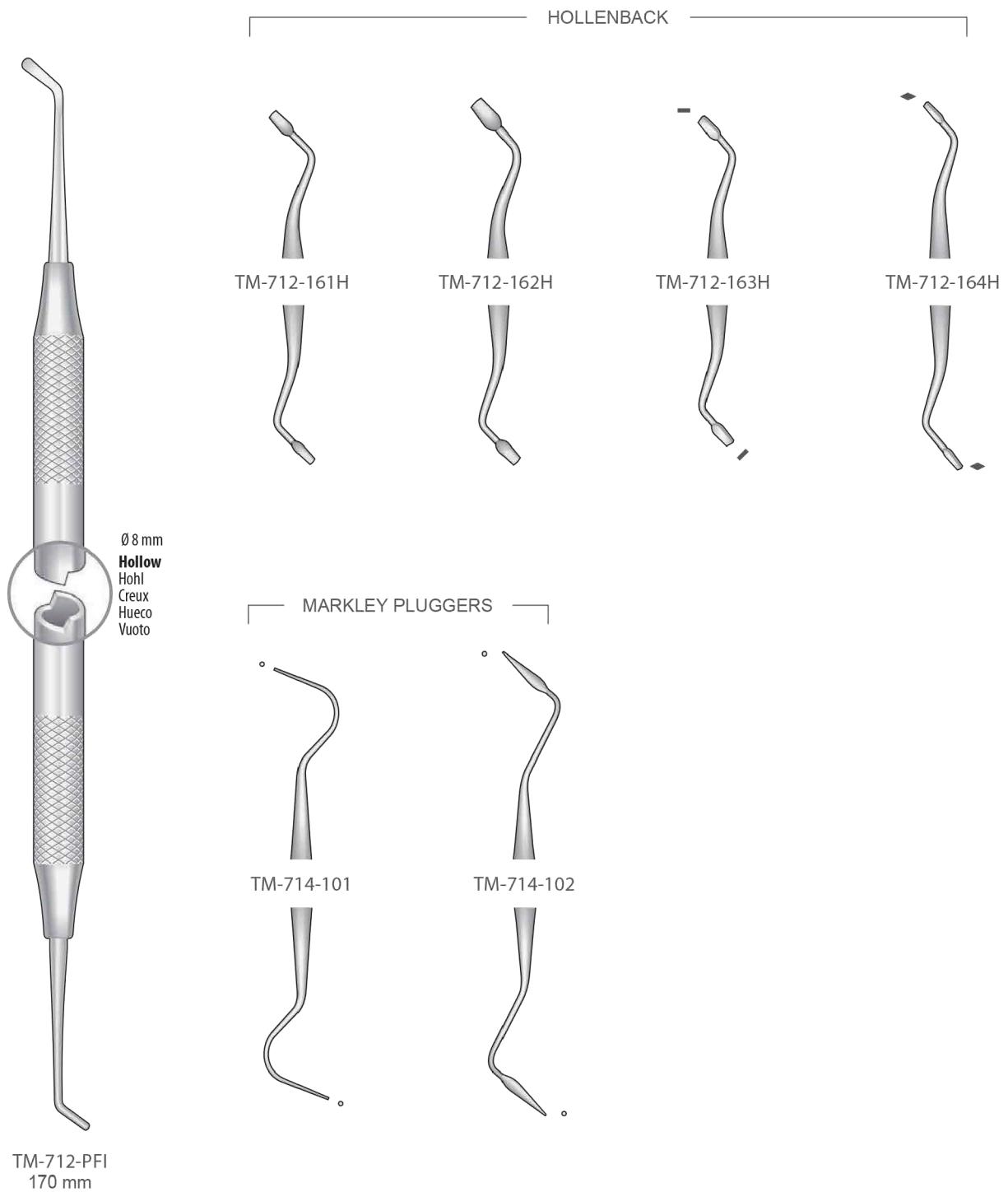


Ø 8 mm  
**Hollow**  
Hohl  
Creux  
Hueco  
Vuoto

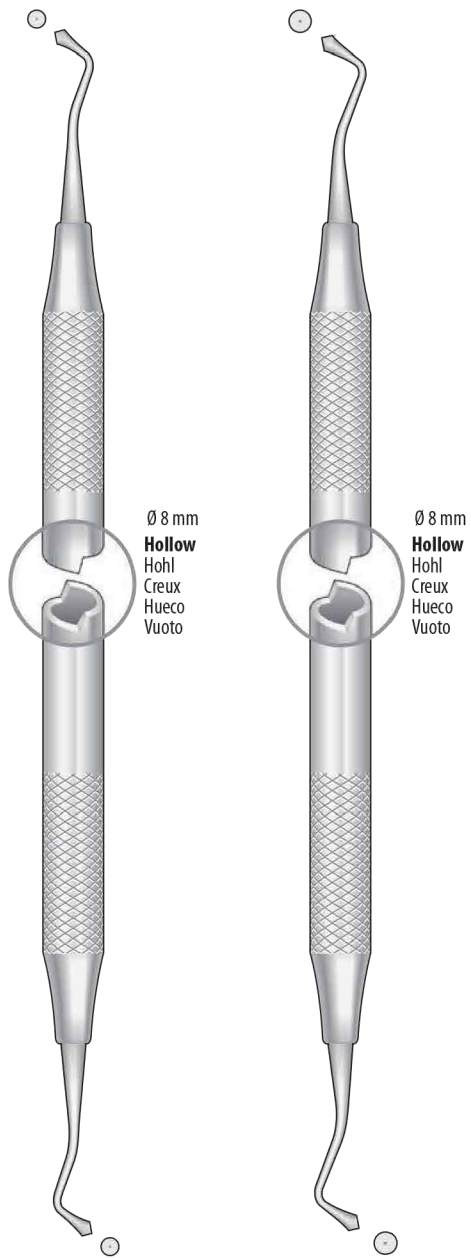
Gerieft - Serrated  
Zigrinati - Estriados  
Striés



TM-712-111L

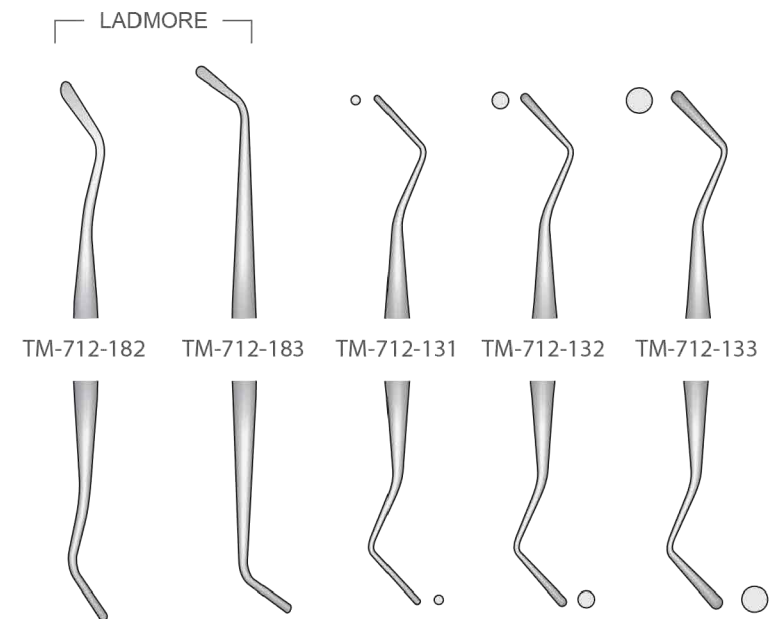
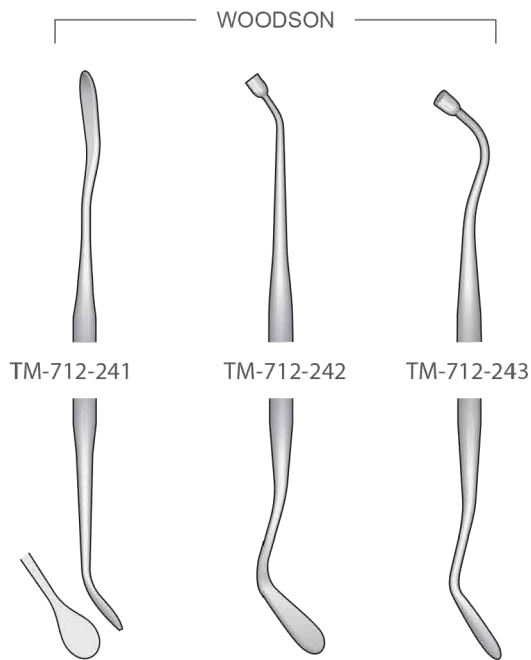


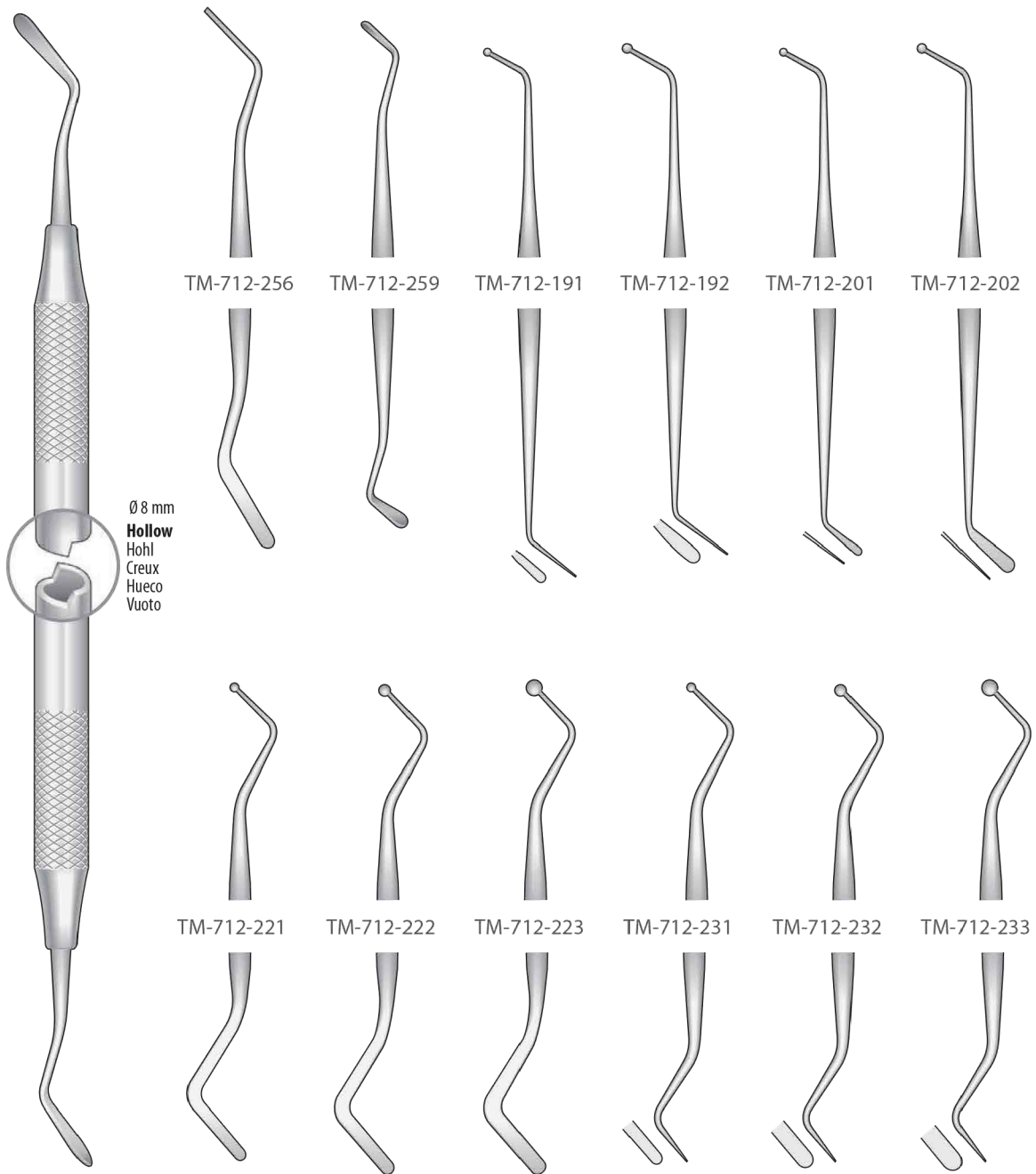
Füllungsinstrumente  
Filling Instruments  
Strumenti per otturazione  
Instrumentos para obturación  
Instruments pour obturation



WESTCOTT  
TM-712-171

WESTCOTT  
TM-712-172



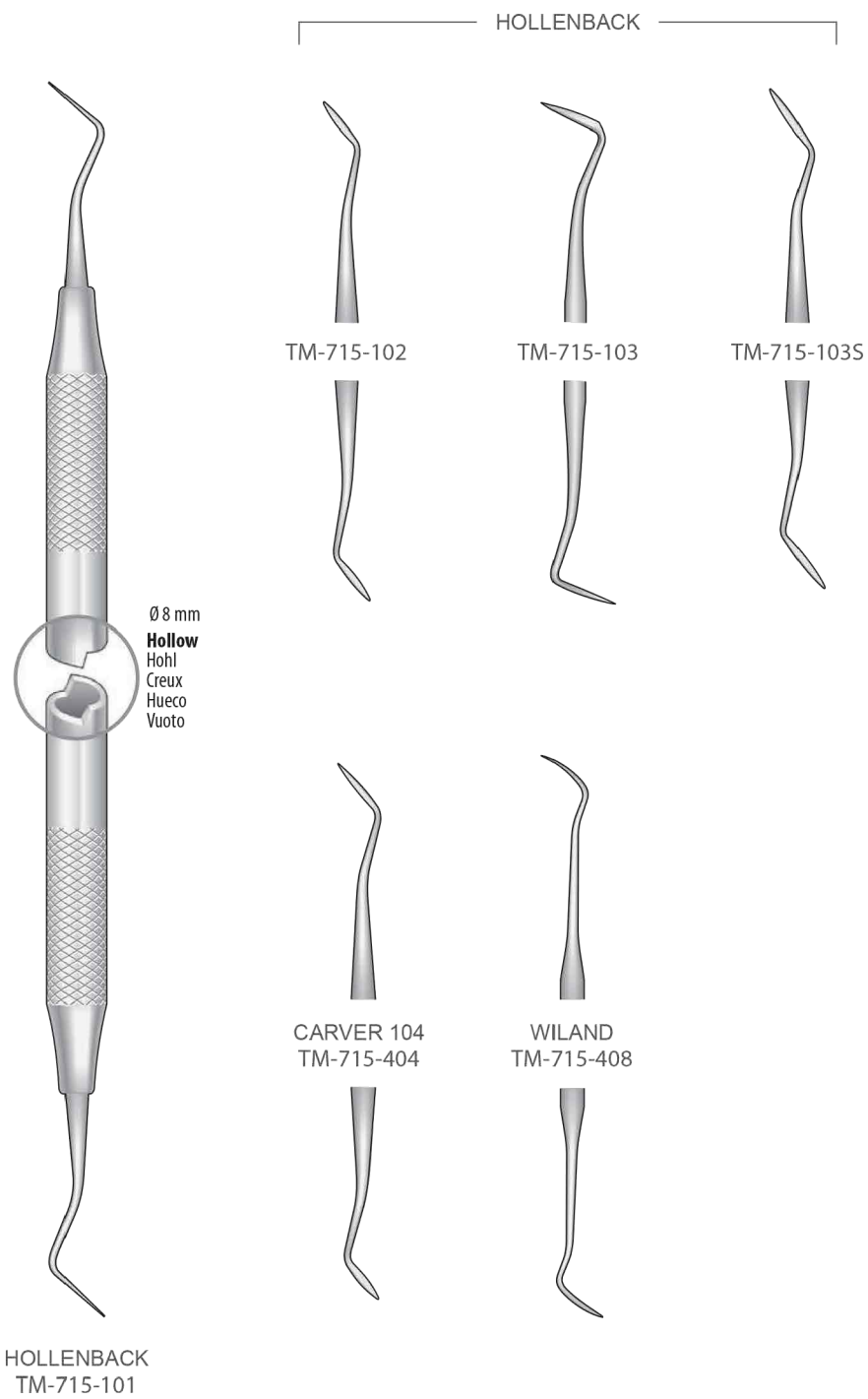


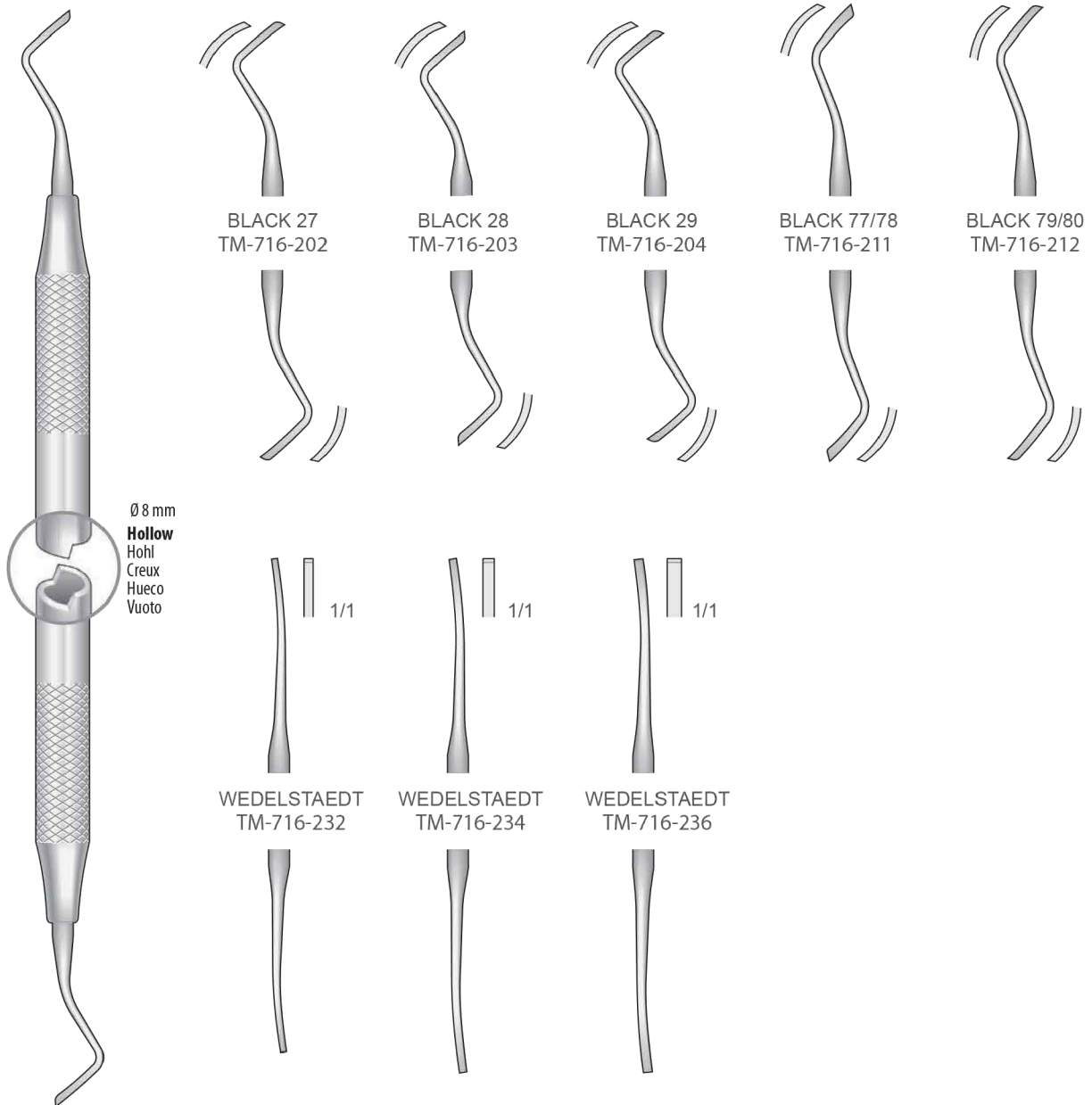
Ø 8 mm  
**Hollow**  
Hohl  
Creux  
Hueco  
Vuoto

TM-712-251



Amalgam Instrumente  
Amalgam carvers  
Strumenti per modellare otturazioni  
Instrumentos para modelar las obturaciones  
Instruments à modeler les obturations

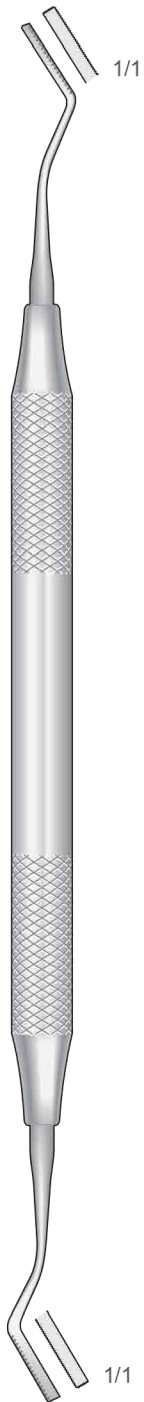




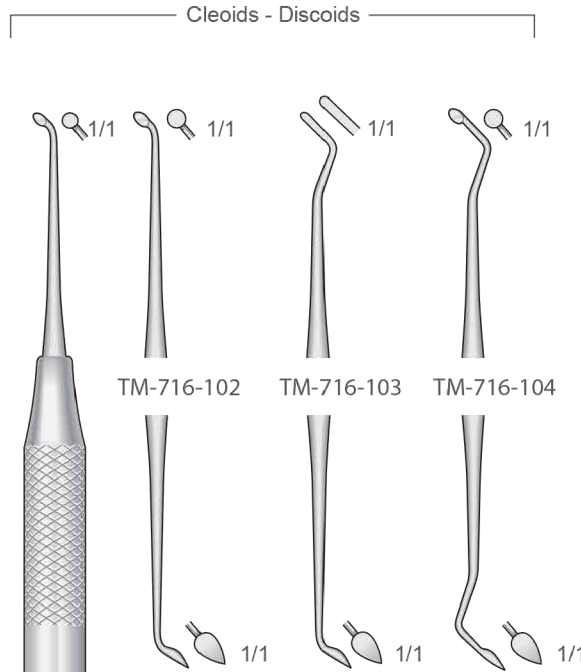
BLACK 26  
TM-716-201

Amalgam Instrumente  
Amalgam carvers  
Strumenti per modellare otturazioni  
Instrumentos para modelar las obturaciones  
Instruments à modeler les obturations

Instrument für Drahrückzug  
Instrument for Retractor wire  
Strumento per filo retrattore  
Instrumento para hilo retractor  
Instruments pour fil racteur



TM-714-CV11

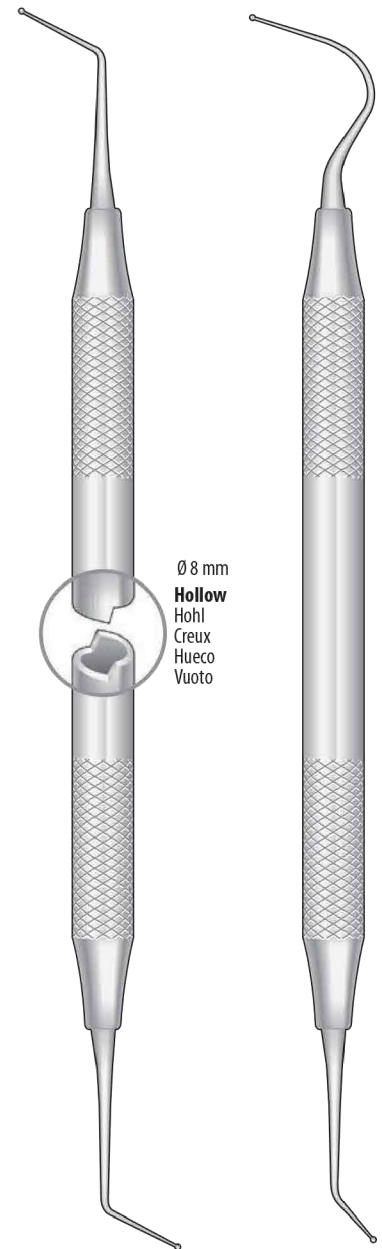


Ø 8 mm  
**Hollow**  
Hohl  
Creux  
Hueco  
Vuoto



TM-716-101

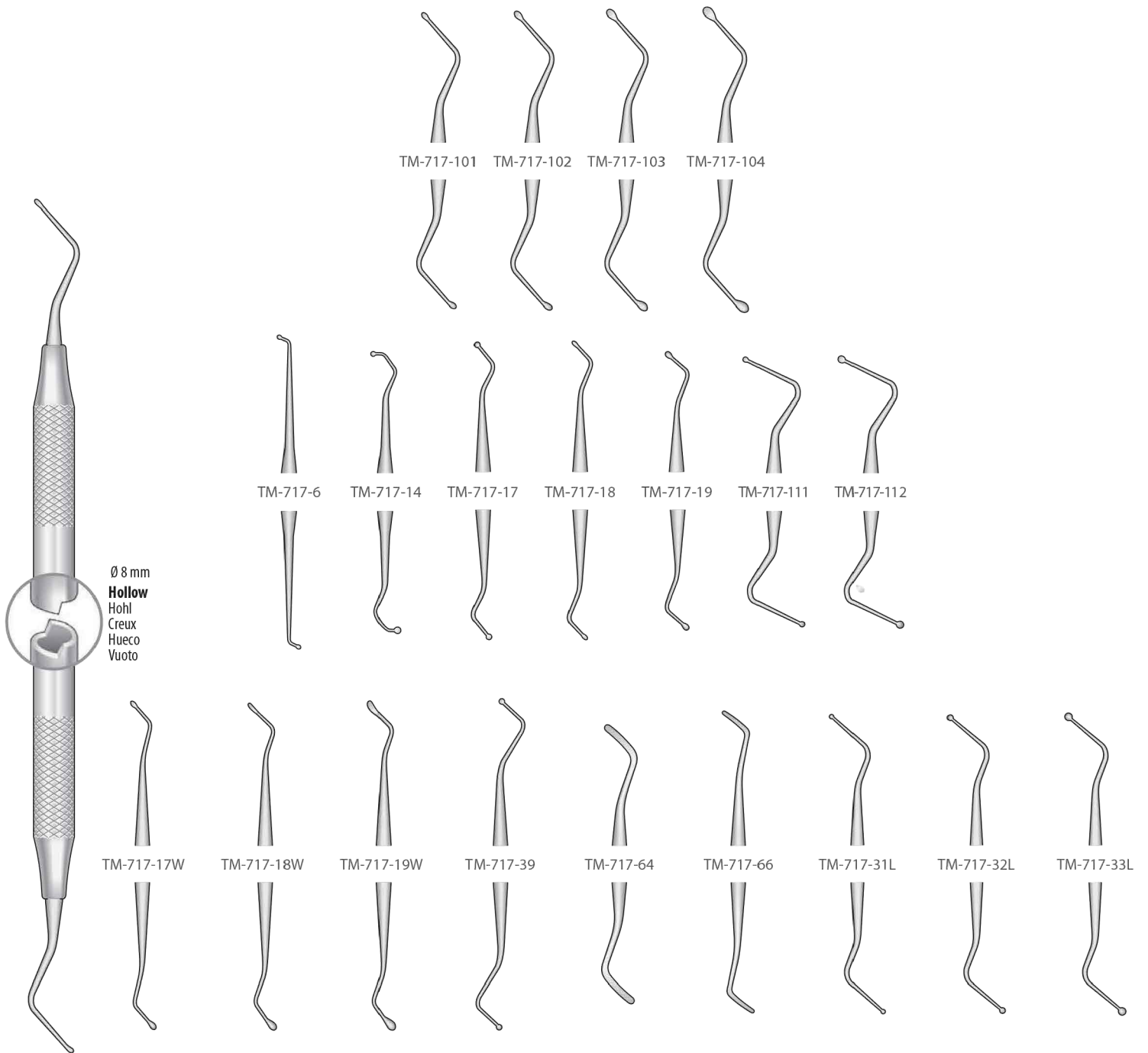
Dykal Applikator  
Placement Instruments  
Applicatori per sottofondo  
Aplicadores de fondo de cavidades  
Applicateurs de fond de cavité



Ø 8 mm  
**Hollow**  
Hohl  
Creux  
Hueco  
Vuoto

TM-713-101

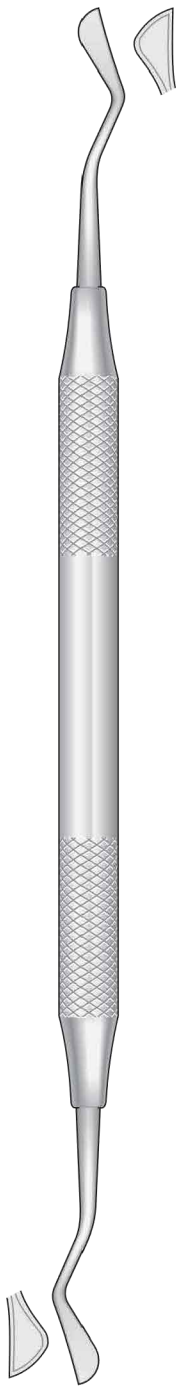
TM-713-102



TM-717-100

Fig. 2

Parodontalmesser  
Gingivectomy knives  
Bisturi per gengivectomia  
Bisturías para la gingivectomía  
Bistouris pour la gingivectomie



KIRKLAND  
TM-718-123  
Fig. 15K/16K

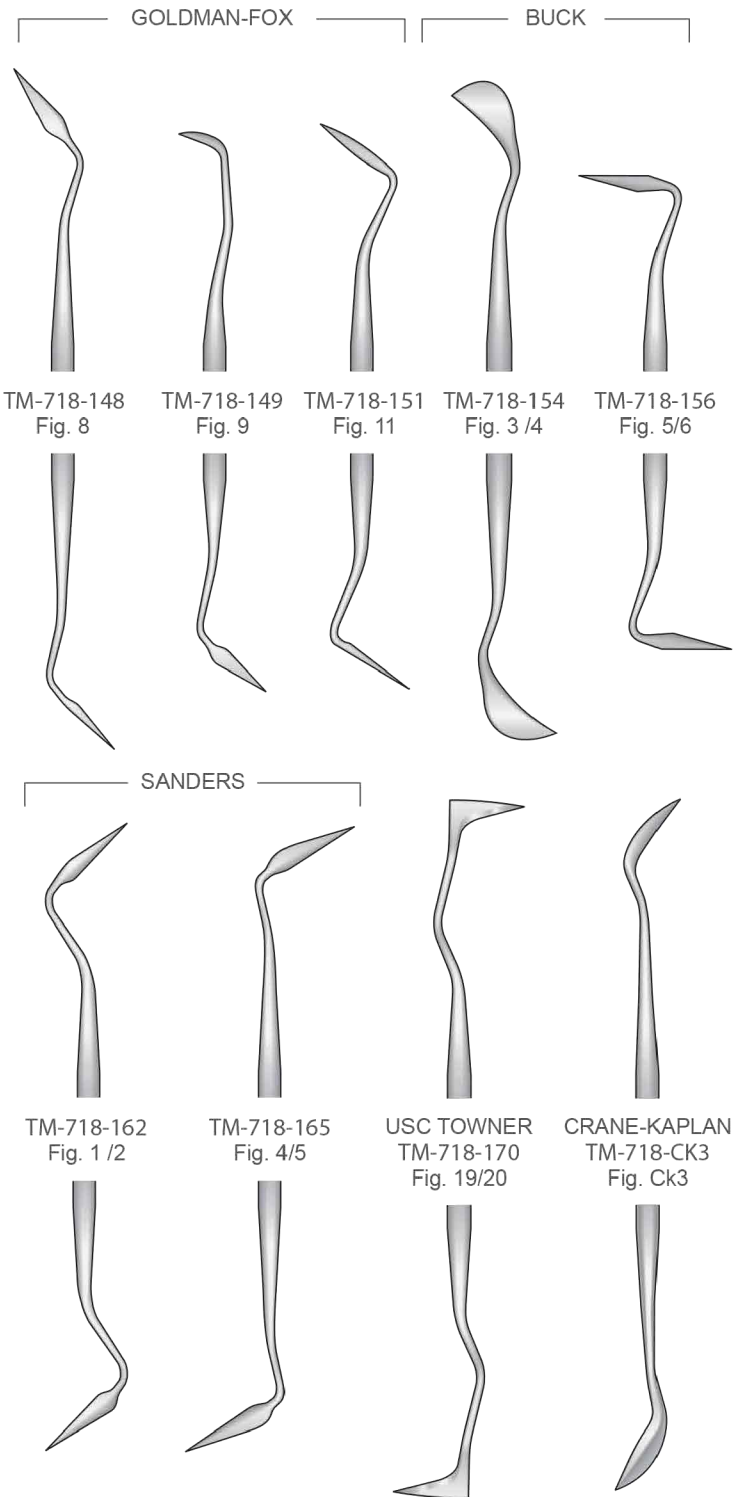


ORBAN  
TM-718-133  
Fig. 1 1/2

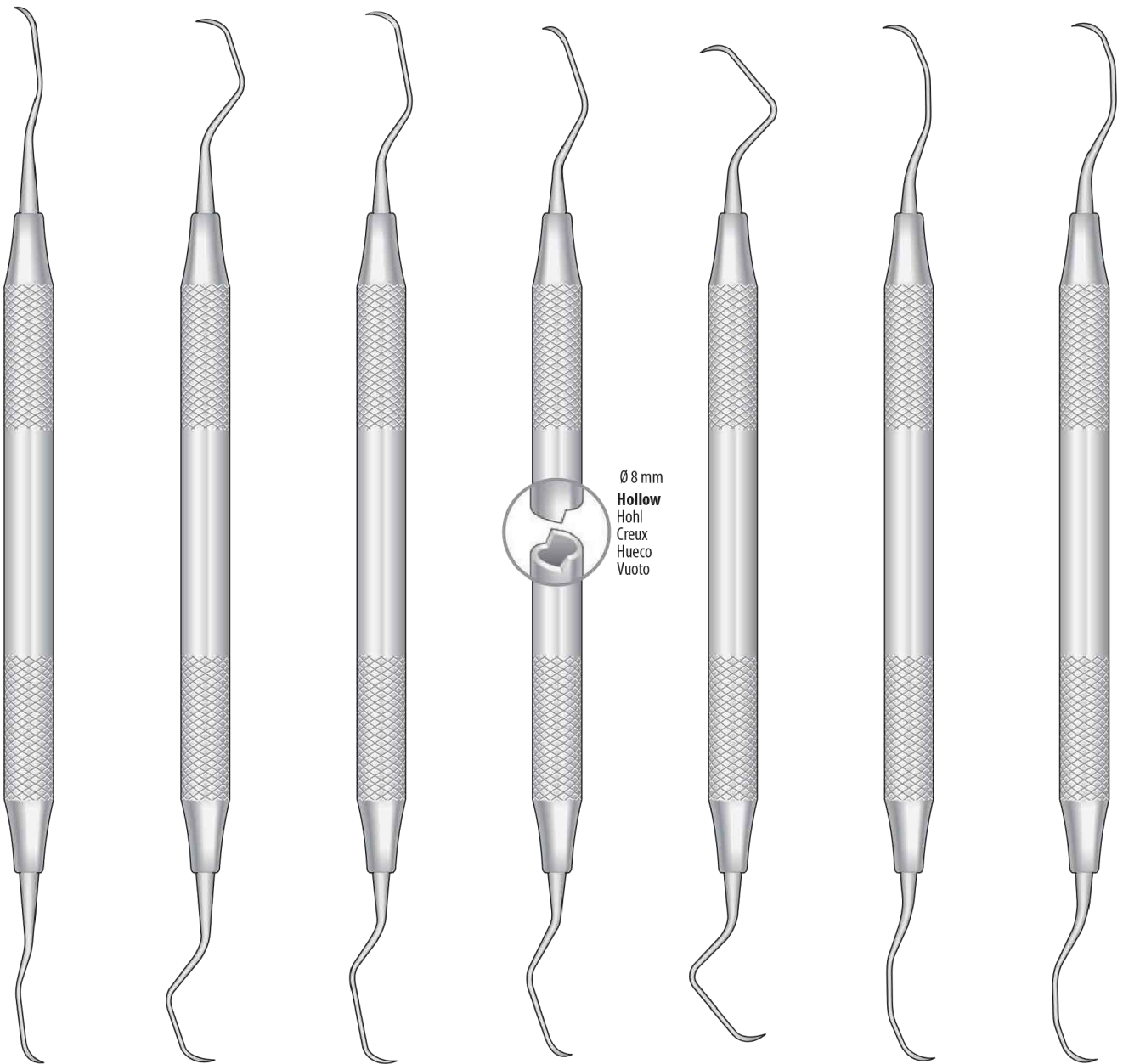
Ø 8 mm  
**Hollow**  
Hohl  
Creux  
Hueco  
Vuoto



GOLDMAN-FOX  
TM-718-147  
Fig. 7



GRACEY



Ø 8 mm  
Hollow  
Hohl  
Creux  
Hueco  
Vuoto

GRACEY  
TM-718-1/2

GRACEY  
TM-718-3/4

GRACEY  
TM-718-5/6

GRACEY  
TM-718-7/8

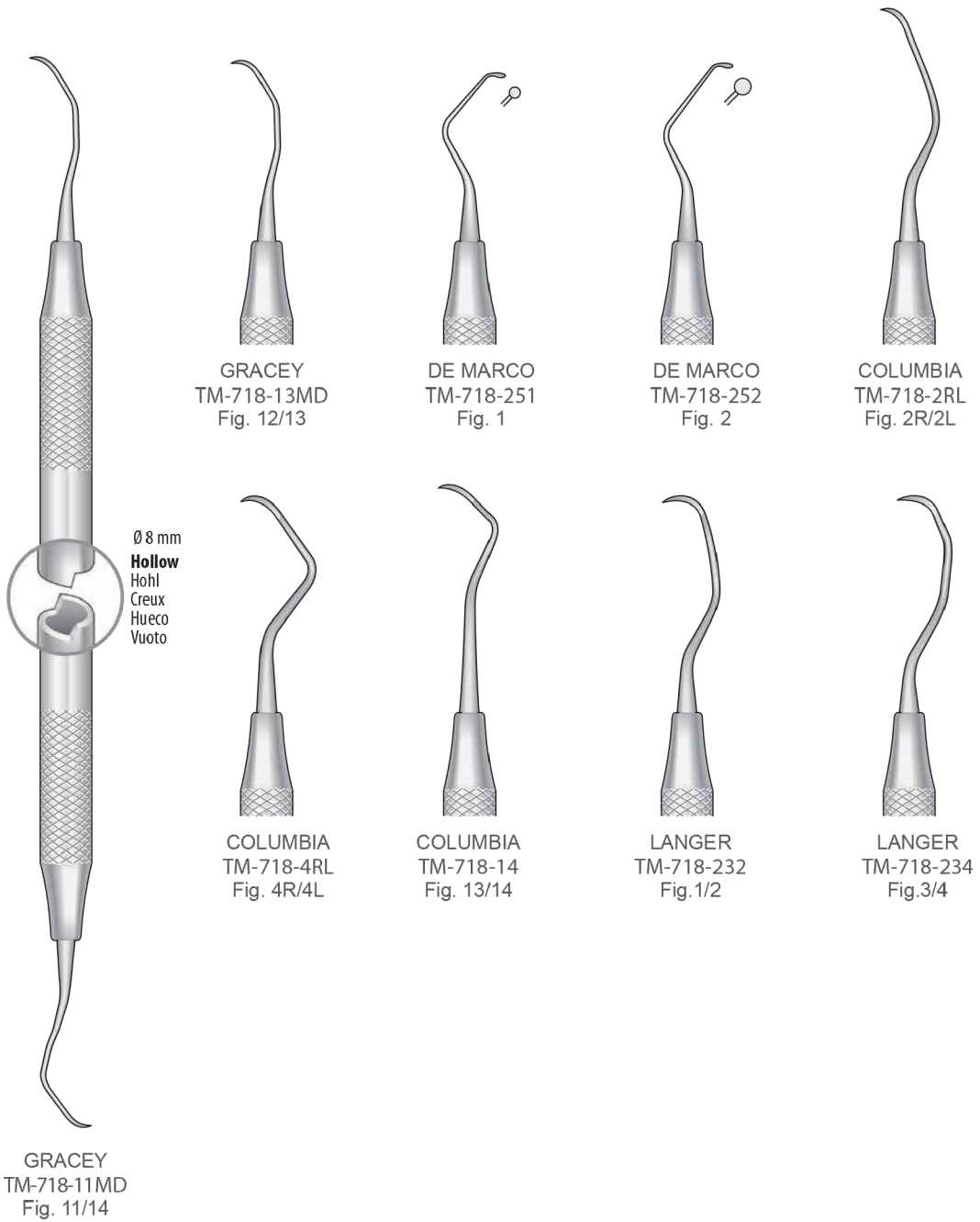
GRACEY  
TM-718-9/10

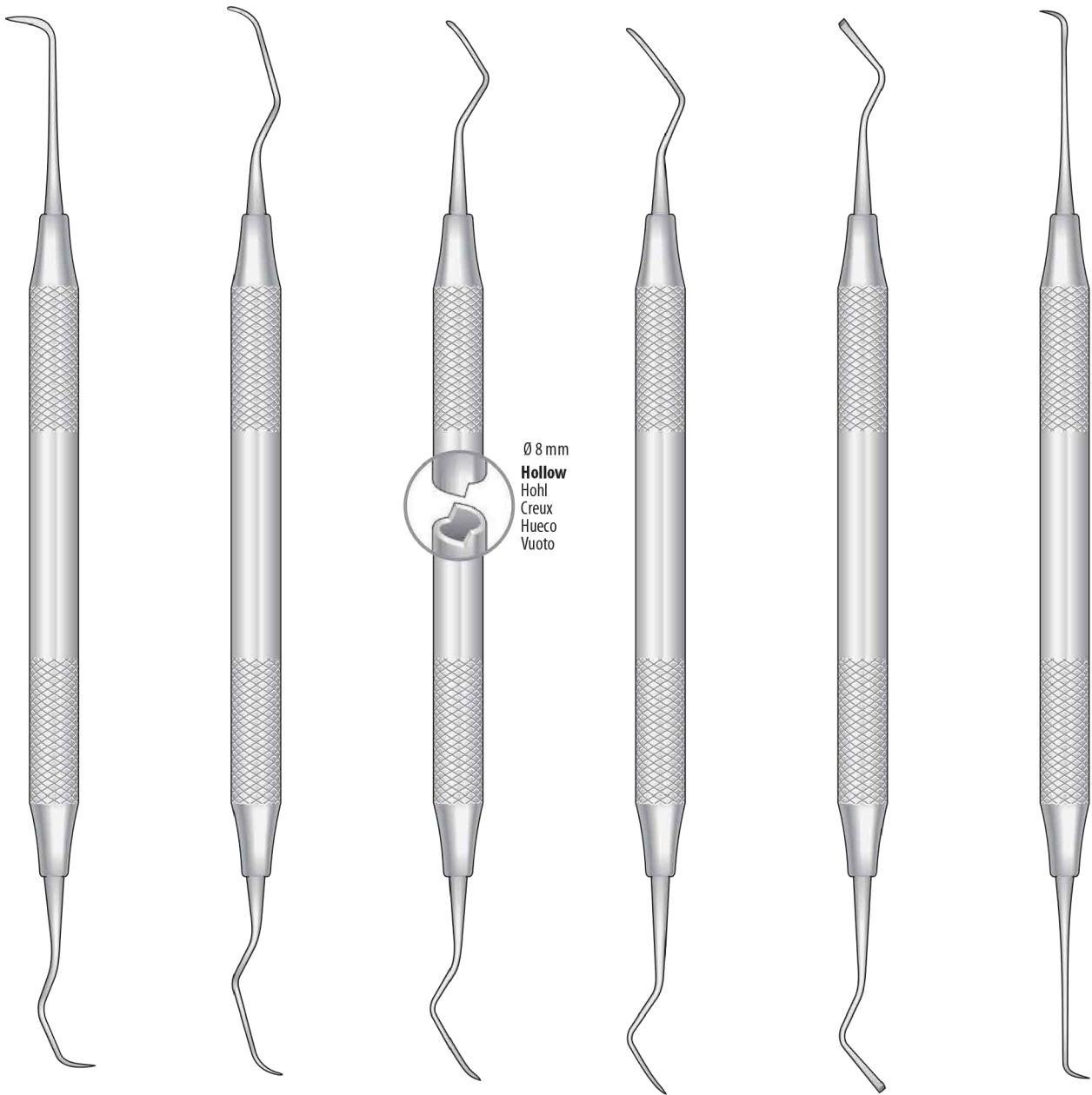
GRACEY  
TM-718-11/12

GRACEY  
TM-718-13/14

Küretten  
Curettes  
Curette  
Curetas  
Curettes

Mesial - Distal





GOLDMAN-FOX  
TM-718-271  
Fig. 1

GOLDMAN-FOX  
TM-718-272  
Fig. 2

GOLDMAN-FOX  
TM-718-273  
Fig. 3

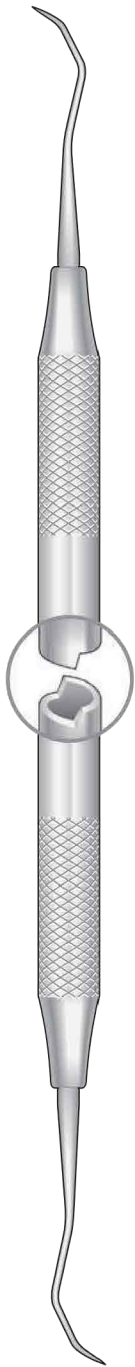
GOLDMAN-FOX  
TM-718-274  
Fig. 4

GOLDMAN-FOX  
TM-718-275  
Fig. 5

GOLDMAN-FOX  
TM-718-277  
Fig. 21



Scaler und Küretten  
Scalers and Curettes  
Scaler e Curette  
Raspadores y Curetas  
Détartreurs et Curettes



MC CALL  
TM-718-282  
Fig. 11/12

Ø 8 mm  
**Hollow**  
Hohl  
Creux  
Hueco  
Vuoto



MC CALL  
TM-718-282A  
Fig. 11A/12A



MC CALL  
TM-718-284  
Fig. 13/14



MC CALL  
TM-718-284S  
Fig. 13S/14S



MC CALL  
TM-718-288S  
Fig. 17S/18S



JAQUETTE  
TM-718-333  
Fig. 30/33

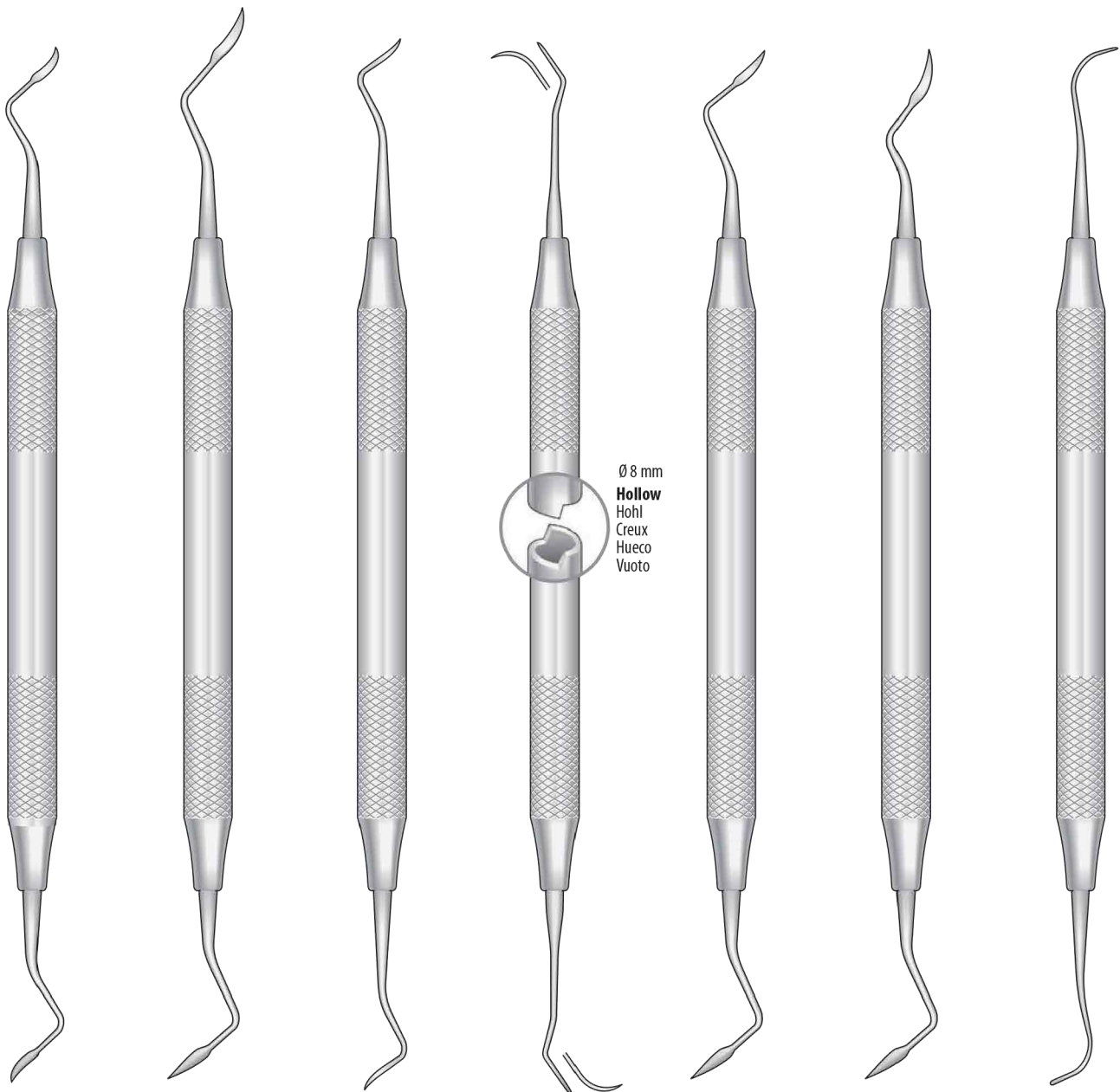


JAQUETTE  
TM-718-332  
Fig. 31/32



JAQUETTE  
TM-718-335  
Fig. 34/35





Ø 8 mm  
**Hollow**  
Hohl  
Creux  
Hueco  
Vuoto

TAYLOR  
TM-718-TO3  
Fig. 2/3

TM-718-204  
Fig. 204

TM-718-204S  
Fig. 204S

TM-718-204SD  
Fig. 204SD

TM-718-CIO3  
Fig. 2/3

CRANE-CAPLAN  
TM-718-CK6  
Fig. 6

YOUNGER-GOOD  
TM-718-YGO8  
Fig. 7/8

Scaler und Küretten  
Scalers and Curettes  
Scaler e Curette  
Raspadores y Curetas  
Détartreurs et Curettes



RULE 23/24  
TM-718-RO4  
Fig. 3 /4



I. UNIVERSITY  
TM-718-268  
Fig. 17/18



TOWNER-JAQUETTE  
TM-719-111  
Fig. U15/33

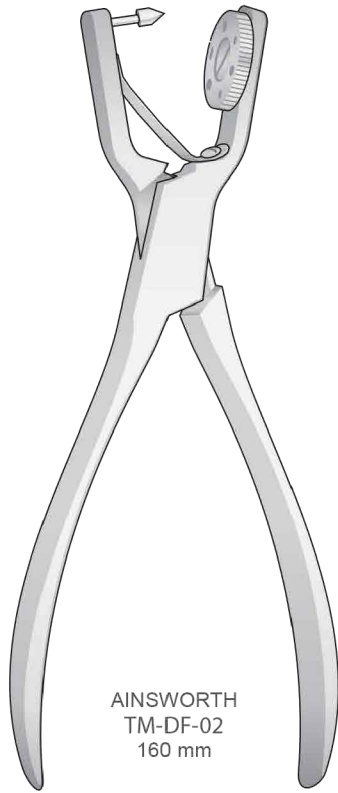
Ø 8 mm  
**Hollow**  
Hohl  
Creux  
Hueco  
Vuoto



TOWNER-JAQUETTE  
TM-719-125  
Fig. H5/33



TOWNER-JAQUETTE  
TM-719-126  
Fig. H6/H7



AINSWORTH  
TM-DF-02  
160 mm

Lochzangen  
Punch Forceps  
Pinze foradiga  
Perforadores  
Pinces à perforer



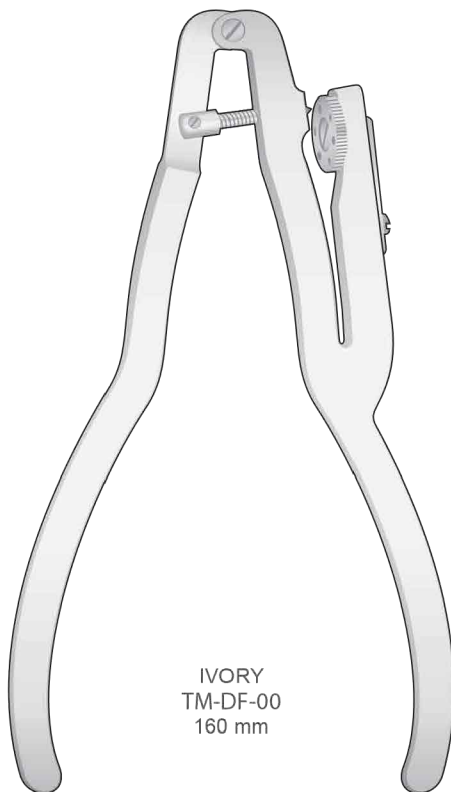
TM-DF-02M  
Feder mit Schraube  
Spring with screw  
Molla con vite  
Muelle con tornillo  
Ressort avec vis



TM-DF-02R  
Lochscheibe  
Punch Disk  
Disco divisore  
Disco agujereado  
Disque perforé



TM-DF-02P  
Stift, mit Schraube  
Pin, with screw  
Perno con vite  
Punzòn con perno  
Broche



IVORY  
TM-DF-00  
160 mm

Lochzangen  
Punch Forceps  
Pinze foradiga  
Perforadores  
Pinces à perforer



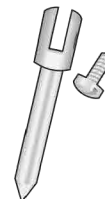
TM-DF-00M  
Spiralfeder  
Spiral Spring  
Molla a spirale  
Muelle espiral  
Ressort en spirale



TM-DF-00L + TM-DF-00V  
Feder mit Schraube  
Spring with screw  
Molla con vite  
Muelle con tornillo  
Ressort avec vis

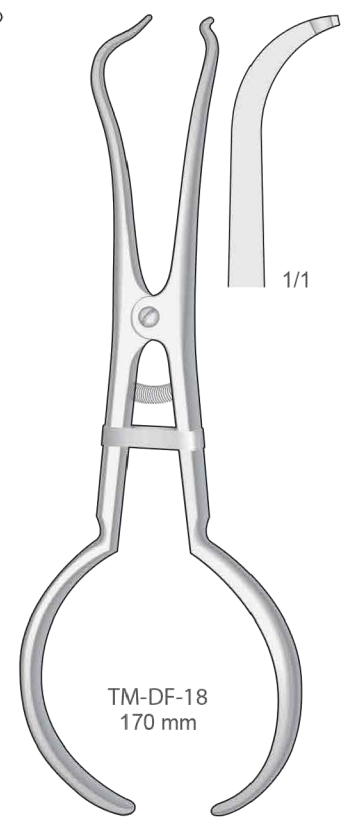
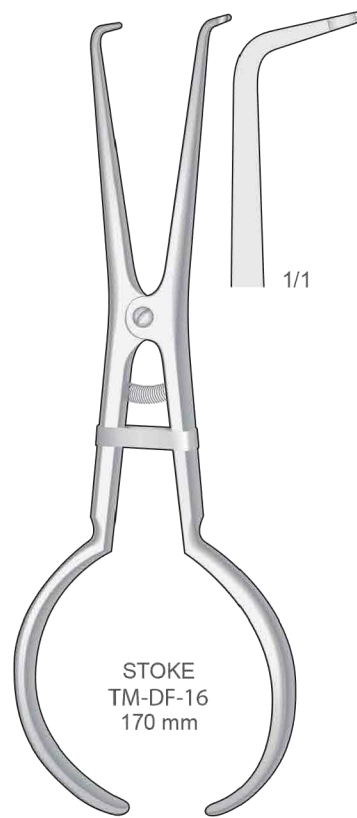
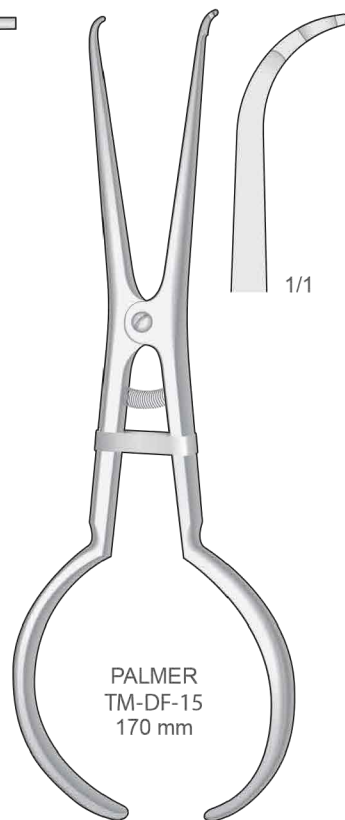
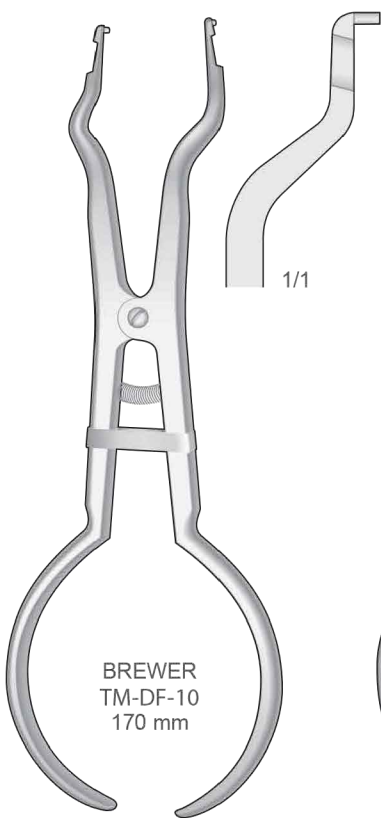


TM-DF-00R  
Lochscheibe  
Punch Disk  
Disco divisore  
Disco agujereado  
Disque perforé



TM-DF-00P + TM-DF-00N  
Stift, mit Schraube  
Pin, with screw  
Perno con vite  
Punzòn con perno  
Broche avec vis

Kofferdam-Klammerzangen  
Rubber-Dam Clamp Forceps  
Pinze per uncini  
Pinzas para grapas dique de goma  
Pinces porte-crampons



Molaren, 12 Stück  
Molars, 12 pieces  
Molari, 12 pezzi  
Molares, 12 piezas  
Molaires, 12 Pièces

Premolaren, 12 Stück  
Premolars, 12 pieces  
Premolari, 12 pezzi  
Premolares, 12 piezas  
Prémolaires, 12 Pièces



TM-DF-40/1  
Fig.1



TM-DF-41/4  
Fig.4



TM-DF-40/2  
Fig.2



TM-DF-41/5  
Fig.5

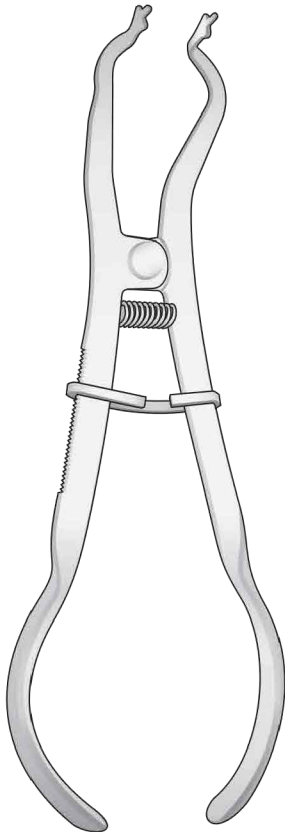


TM-DF-40/3  
Fig.3

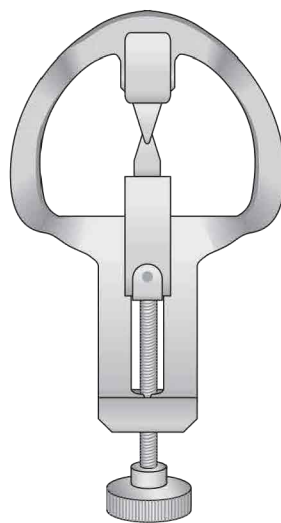


TM-DF-41/6  
Fig.6

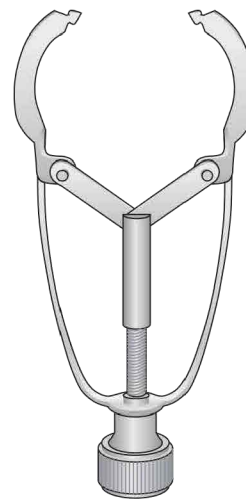
Kofferdam-Klammerzangen  
Rubber-Dam Clamp Forceps  
Pinze per uncini  
Pinzas para grapas dique de goma  
Pincas porte-crampons



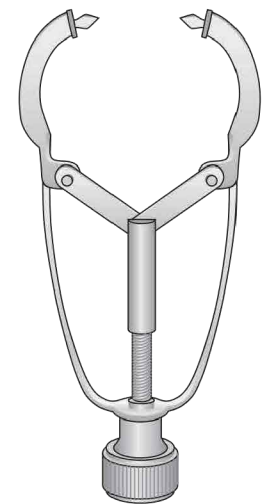
IVORY  
TM-DF-12  
170 mm



IVORY  
TM-DF-43  
Fig. 14



IVORY  
TM-DF-40  
Fig. 1



IVORY  
TM-DF-41  
Fig. 12

Kofferdam Instrumente  
Rubber-Dam Instruments  
Strumenti per diga  
Instrumentos para dique de goma  
Instruments pour digue de caoutchouc

Kofferdam-Klammern  
Rubber-Dam Clamps  
Uncini per diga  
Clamps para diques  
Crampons pour digue



IVORY  
TM-DF-126  
# 26



IVORY  
TM-DF-127  
# 27



IVORY  
TM-DF-128  
# 28



IVORY  
TM-DF-129  
# 29



IVORY  
TM-DF-130  
# 30



IVORY  
TM-DF-131  
# 31

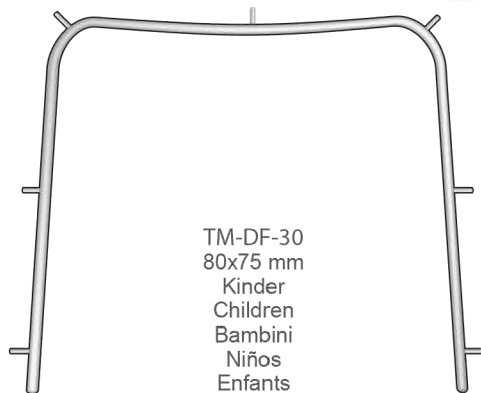


IVORY  
TM-DF-151  
# 51

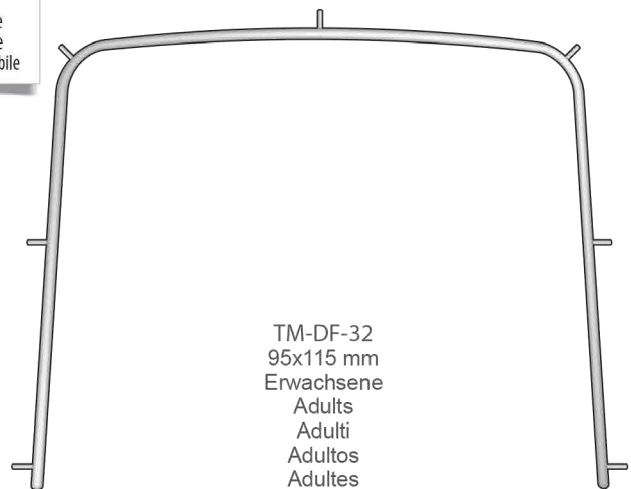


IVORY  
TM-DF-160  
# 60

Kofferdam-Rahmen  
Rubber-Dam Frames  
Telaio per diga  
Cuadro para diques  
Cadre à digue



TM-DF-30  
80x75 mm  
Kinder  
Children  
Bambini  
Niños  
Enfants

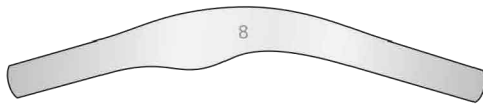


TM-DF-32  
95x115 mm  
Erwachsene  
Adults  
Adulti  
Adultos  
Adultes

Molaren, 12 Stück  
Molars, 12 pieces  
Molari, 12 pezzi  
Molares, 12 piezas  
Molaires, 12 Pièces



TM-DF-03/7  
#7



TM-DF-03/8  
#8



TM-DF-03/9  
#9

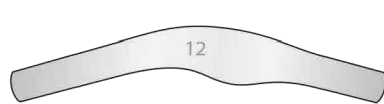


TM-DF-03/10  
#10

Premolaren, 12 Stück  
Premolars, 12 pieces  
Premolari, 12 pezzi  
Premolares, 12 piezas  
Prémolaires, 12 Pièces



TM-DF-03/11  
#11



TM-DF-03/12  
#12



TM-DF-03/13  
#13

TOFFLEMIRE  
Universal



TM-DF-03/1  
#1



TM-DF-03/2  
#2



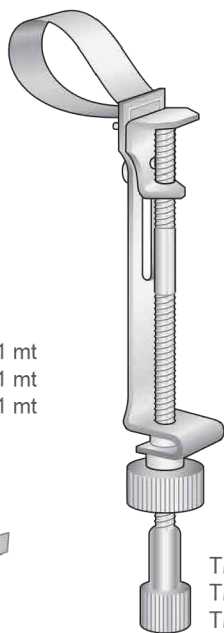
TM-DF-03/3  
#3



TM-DF-01/5 5 mm x 1 mt  
TM-DF-01/6 6 mm x 1 mt  
TM-DF-01/7 7 mm x 1 mt



TM-DF-05/5 5 mm x 5 mt  
TM-DF-05/6 6 mm x 5 mt  
TM-DF-05/7 7 mm x 5 mt



TM-DF-06 5 mm  
TM-DF-08 6 mm  
TM-DF-09 7 mm

IVORY  
TM-DF-06/TM-DF-09  
#8

Paar - Pair  
Coppia - Par  
Paire

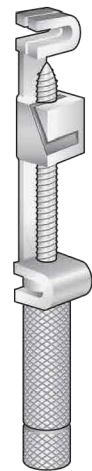


#1  
Rechts  
Right  
Destra  
Derecha  
Droite



#2  
Links  
Left  
Sinistra  
Izquierda  
Gauche

NYSTRÖM  
TM-DF-04  
#1 + #2



TOFFLEMIRE  
TM-DF-07  
Universal



Restaurative Zahnheilkunde  
Dental Restoration  
Odontoiatria conservativa  
Odontología conservadora  
Odontologie conservatrice

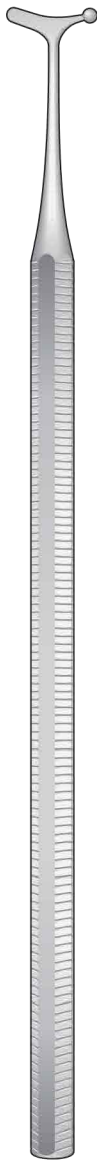
Füllungsinstrumente  
Filling Instruments  
Strumenti per otturazione  
Instrumentos para obturación  
Instruments pour obturation



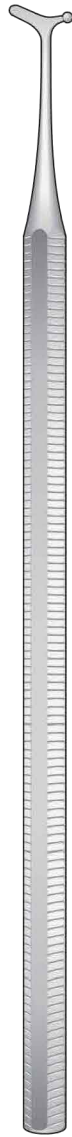
WHITE  
TM-B-3  
n°28



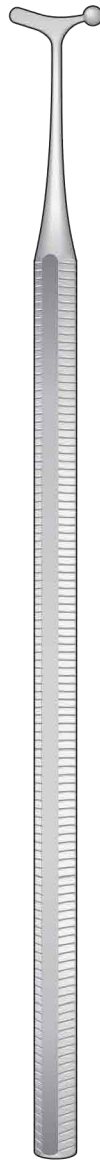
WHITE  
TM-B-4  
n°29



WHITE  
TM-B-32  
n°32



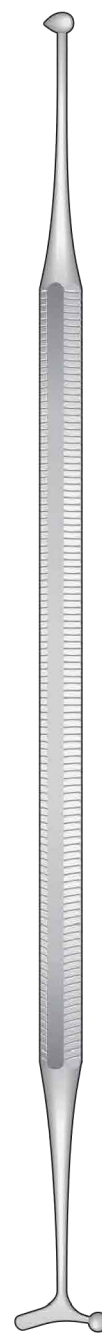
WHITE  
TM-B-33  
n°33



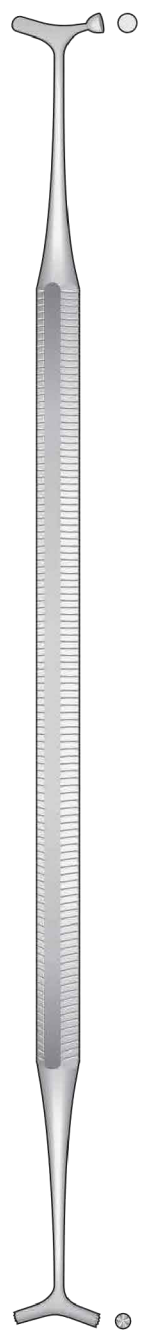
WHITE  
TM-B-34  
n°34



WHITE  
TM-B-28/29  
Doppio



WHITE  
TM-B-31/32  
Doppio

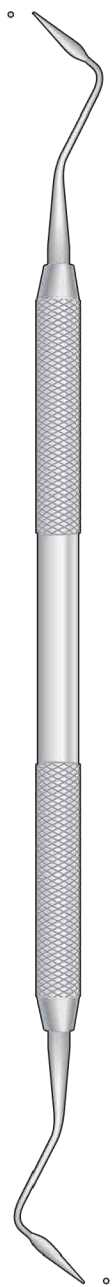


BENNETT  
TM-B-35  
170 mm

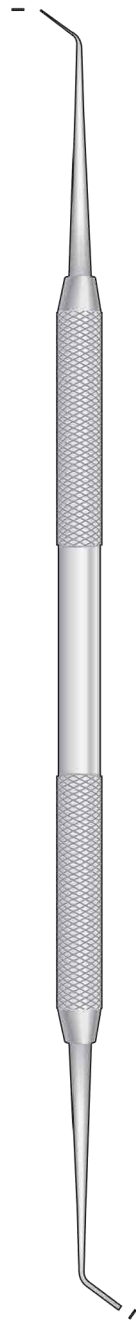
MARKLEY PLUGGERS  
Amalgam Instrumente  
Amalgam Instruments  
Strumenti per amalgama  
Instrumentos para amalgama  
Instruments à amalgame



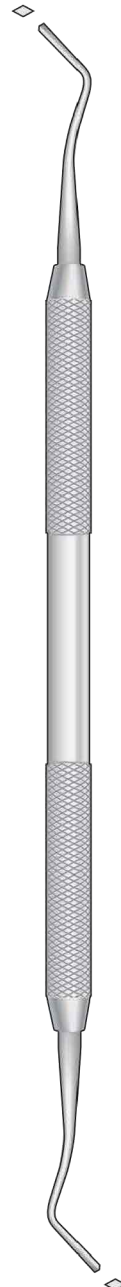
TM-PM-1  
Fig.1M



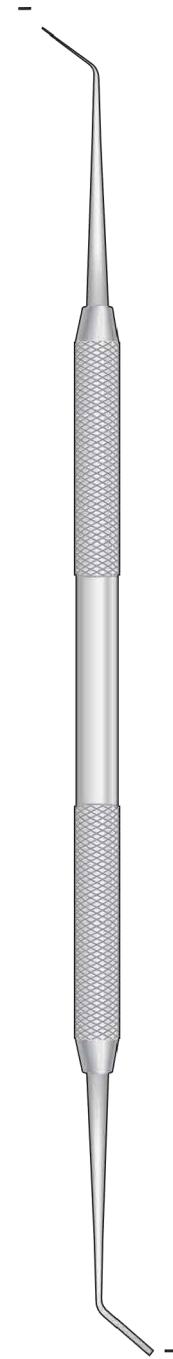
TM-PM-2  
Fig.2M



TM-PM-3  
Fig.3M



TM-PM-4  
Fig.4M

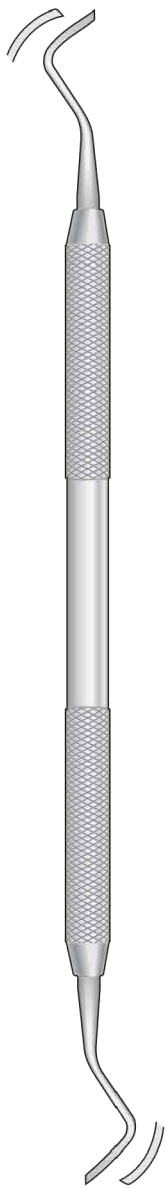


TM-PM-5  
Fig.5M

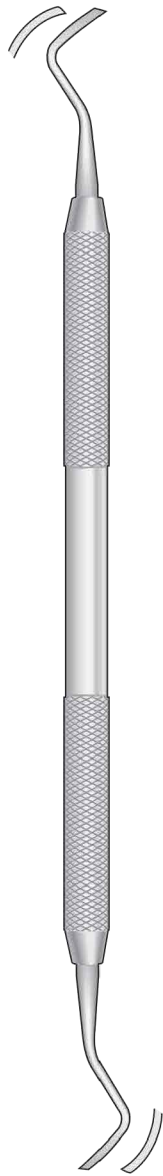


TM-PM-6  
Fig.6M

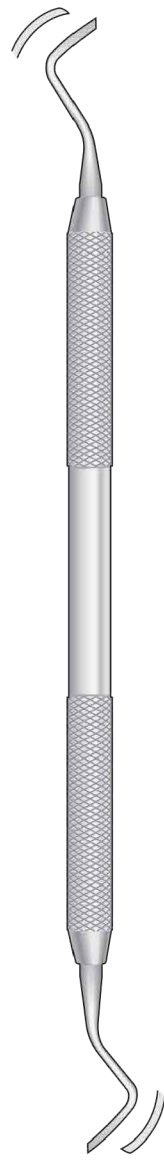
Schmelzinstrumente  
Enamel Instruments  
Strumenti da smalto  
Instrumentos para esmalte  
Instruments à émail



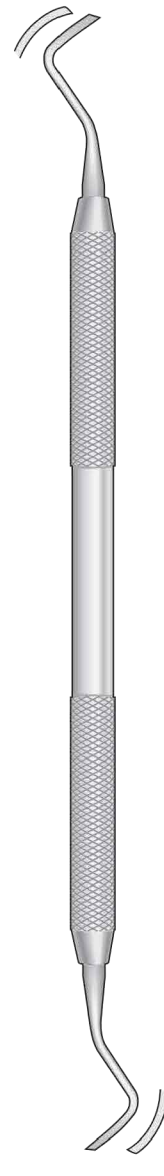
BLACK  
TM-TS-1  
Fig.26



BLACK  
TM-TS-2  
Fig.27



BLACK  
TM-TS-3  
Fig.28



BLACK  
TM-TS-4  
Fig.29



TM-E-0  
Fig.0



TM-E-1  
Fig.1



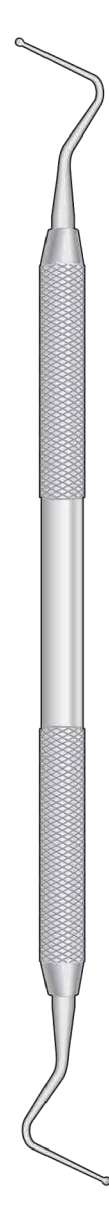
TM-E-2  
Fig.2



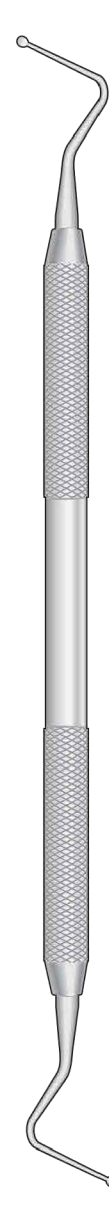
TM-E-3  
Fig.3



TM-E-4  
Fig.4



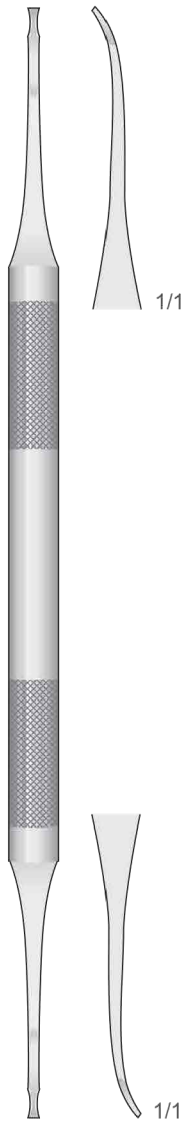
TM-EC-1  
Fig.1



TM-EC-2  
Fig.2

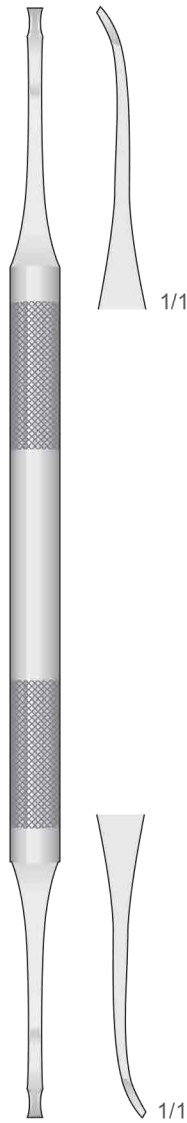
Meißel für Parodontologie  
Periodontal Chisels  
ScalPELLI parodontali  
Cinceles periodontales  
Burins parodontaux

Fig. 1



FEDI  
TM-OF-1  
175 mm

Fig. 2



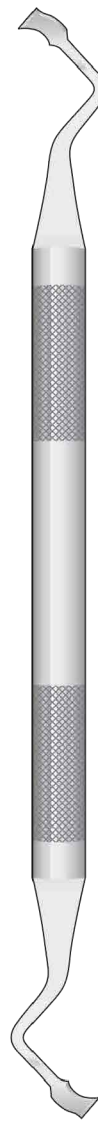
FEDI  
TM-OF-2  
175 mm

Fig. 3



FEDI  
TM-OF-3  
170 mm

Fig. 4



OCHSENBEIN  
TM-OSB-4A  
170 mm



TM-OSB-4  
170 mm

Bevel IN  
Fig.1



OCHSENBEIN-1  
TM-OSB-1  
165 mm

Bevel OUT  
Fig.2



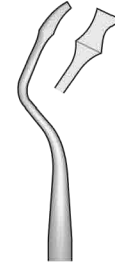
OCHSENBEIN-2  
TM-OSB-2  
165 mm



TG CHISELS  
TM-718-113



OCHSENBEIN-3  
TM-718-103



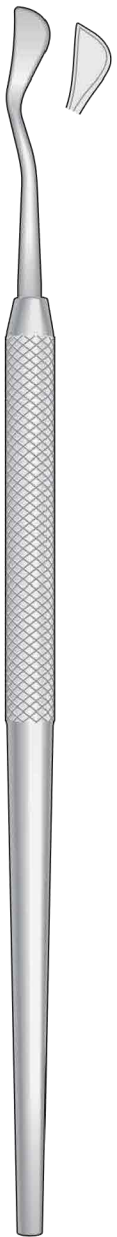
OCHSENBEIN-4  
TM-718-104



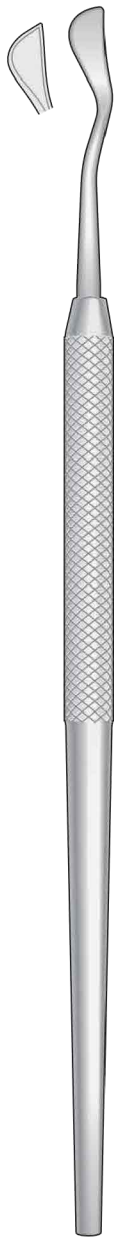
RHODES BACK ACTION  
TM-718-107



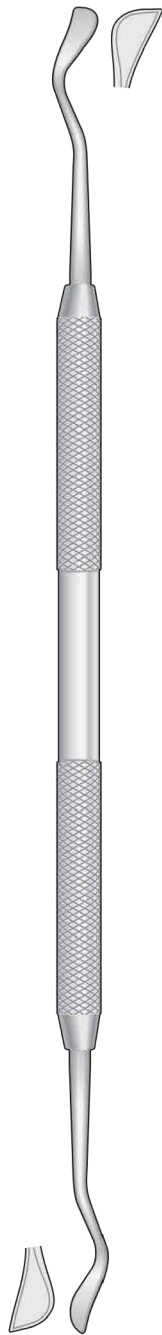
Parodontalmesser  
Gingivectomy Knives  
Bisturi per gengivectomia  
Bisturís para la gengivectomía  
Bistouris pour la gengivectomie



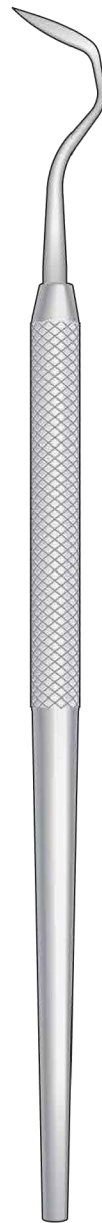
KIRKLAND  
TM-KKD-1  
Fig. 15K



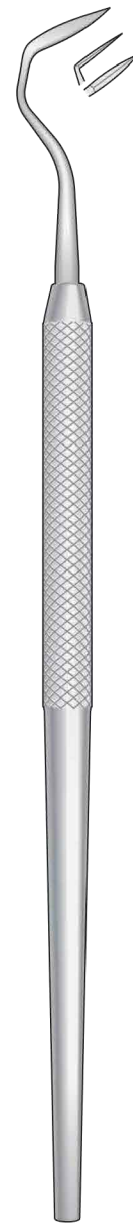
KIRKLAND  
TM-KKD-2  
Fig. 16K



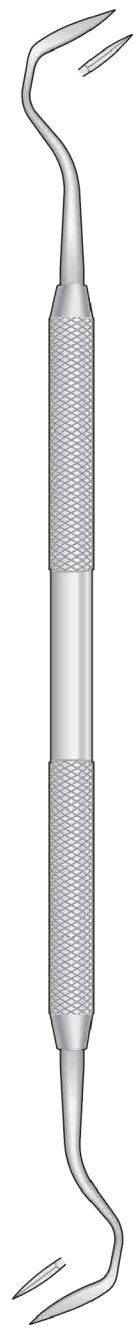
KIRKLAND  
TM-KKD-4  
Fig. 15K - Fig. 16K



ORBAN  
TM-OBN-1  
Fig. 1



ORBAN  
TM-OBN-2  
Fig. 2



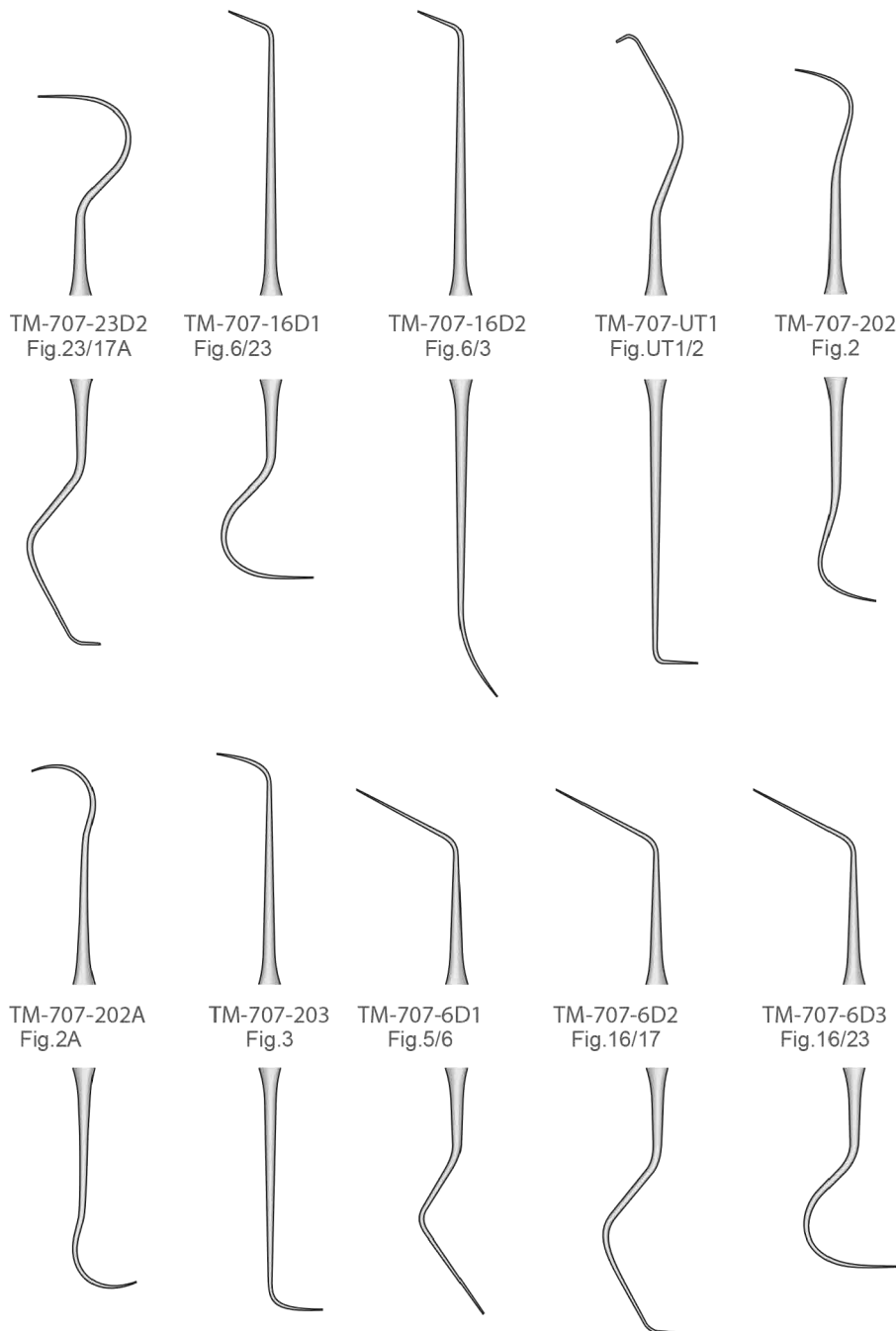
ORBAN  
TM-OBN-4  
Fig. 1 - Fig. 2

Doppelendiger Zahnsonden  
Double-ended Explorer  
Sonda falce doppia  
Sonda exploradora doble  
Sonde exploratrice double



Ø 8 mm  
**Hollow**  
Hohl  
Creux  
Hueco  
Vuoto

TM-707-23D1  
Fig.23/17



TM-707-23D2  
Fig.23/17A

TM-707-16D1  
Fig.6/23

TM-707-16D2  
Fig.6/3

TM-707-UT1  
Fig.UT1/2

TM-707-202  
Fig.2

TM-707-202A  
Fig.2A

TM-707-203  
Fig.3

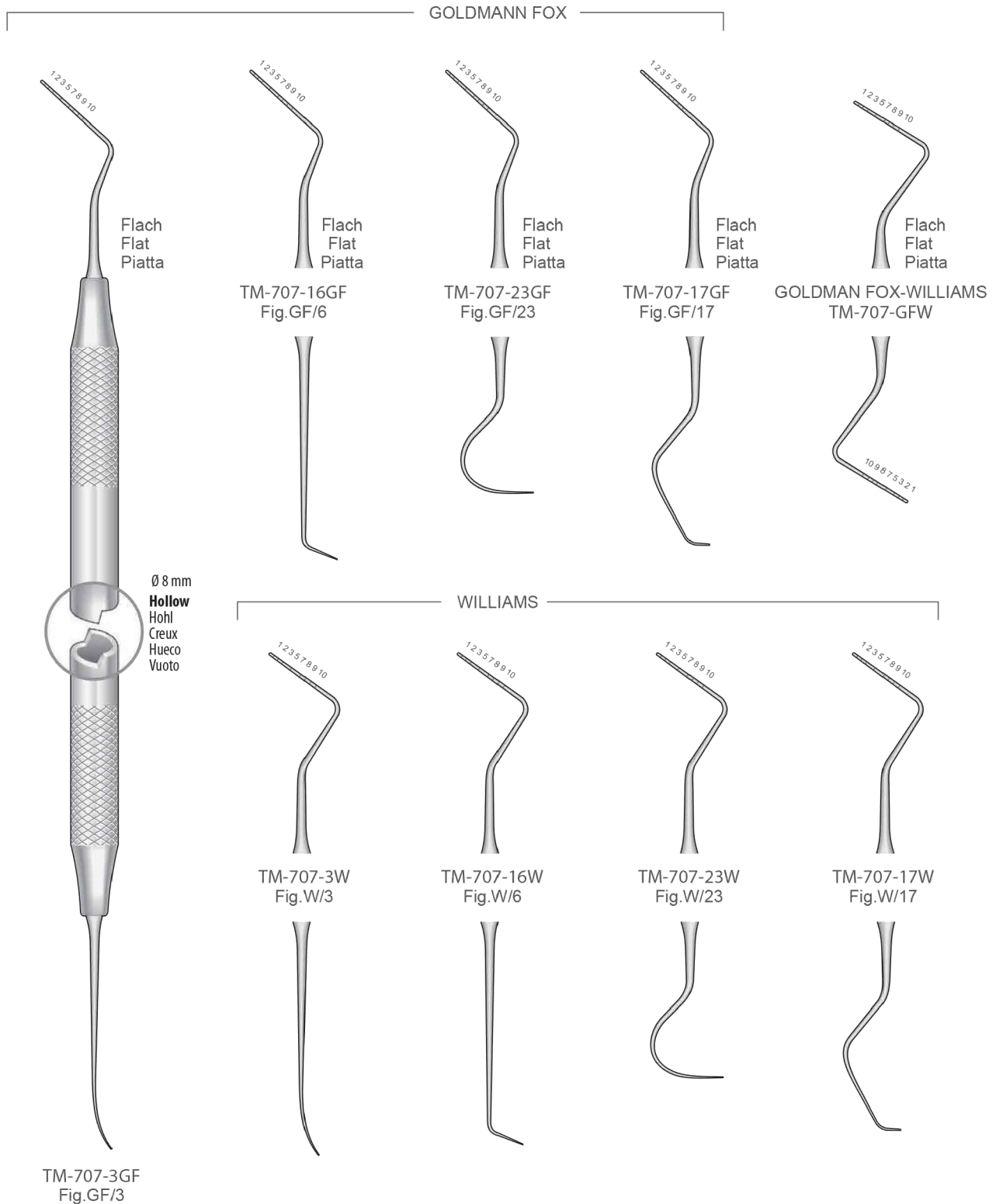
TM-707-6D1  
Fig.5/6

TM-707-6D2  
Fig.16/17

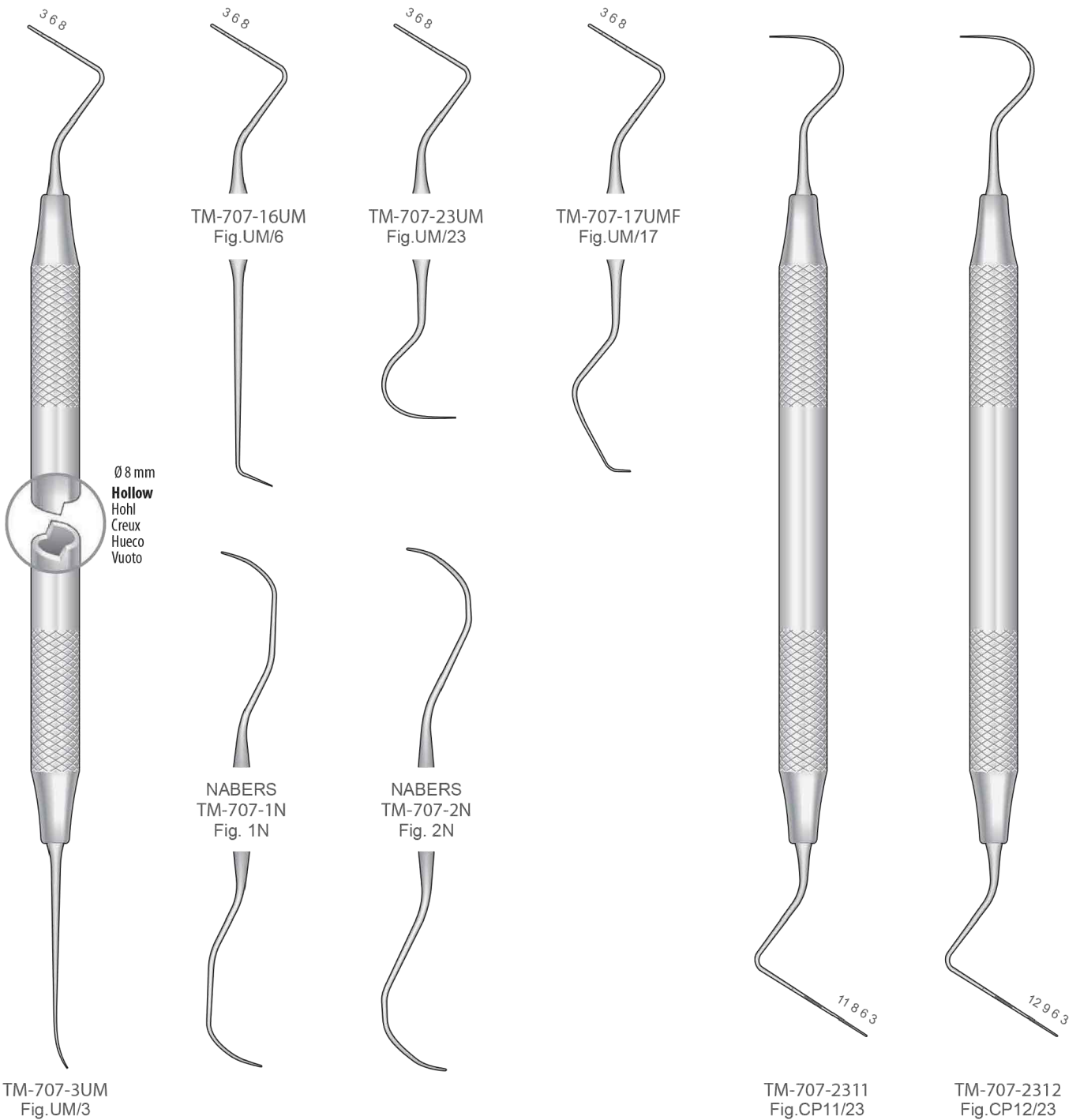
TM-707-6D3  
Fig.16/23



Doppelendiger Parodontometer  
 Double-ended Periodontal Probes  
 Sondes parodontales doubles  
 Sonde parodontali doppie  
 Sondas parodontales doubles

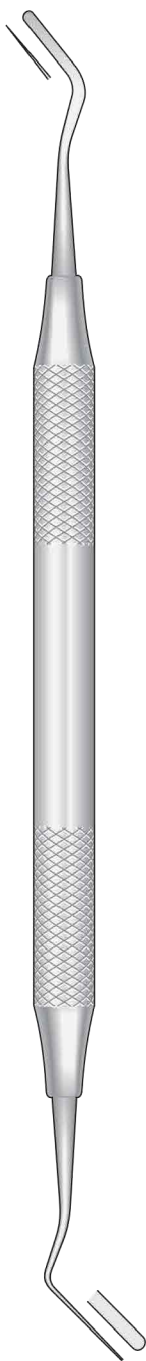


UNIVERSITY OF MICHIGAN

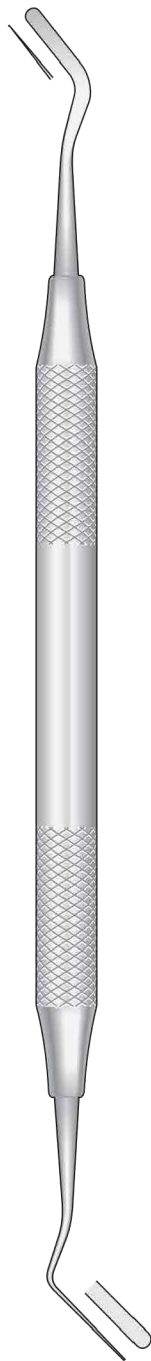


Spateln - Füllungsinstrumente  
 Spatulas - Filling Instruments  
 Spatole - Strumenti per otturazione  
 Espátulas - Instrumentos para obturación  
 Spatules - Instruments pour obturation

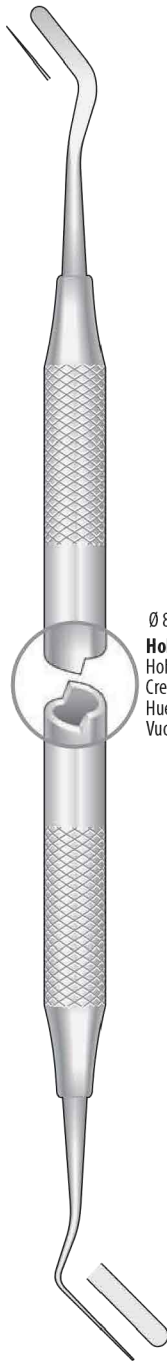
Heidemann Spateln  
 Heidemann Spatulas  
 Spatole Heidemann  
 Espátulas Heidemann  
 Spatules Heidemann



HEIDEMANN  
 TM-711-301  
 Fig.1

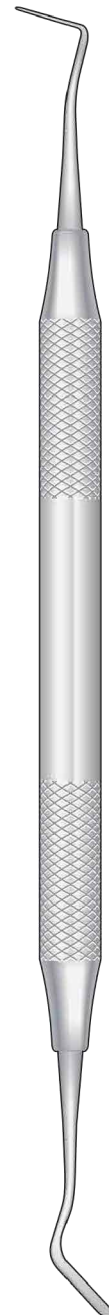


HEIDEMANN  
 TM-711-302  
 Fig.2

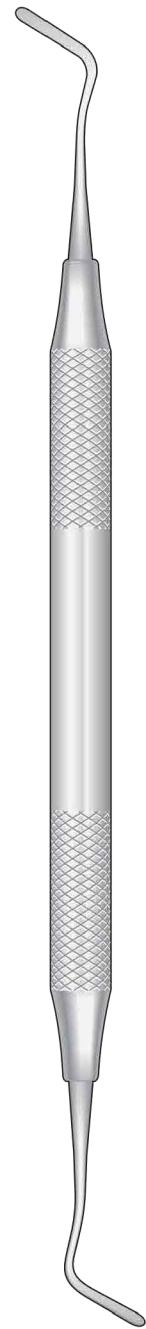


HEIDEMANN  
 TM-711-303  
 Fig.3

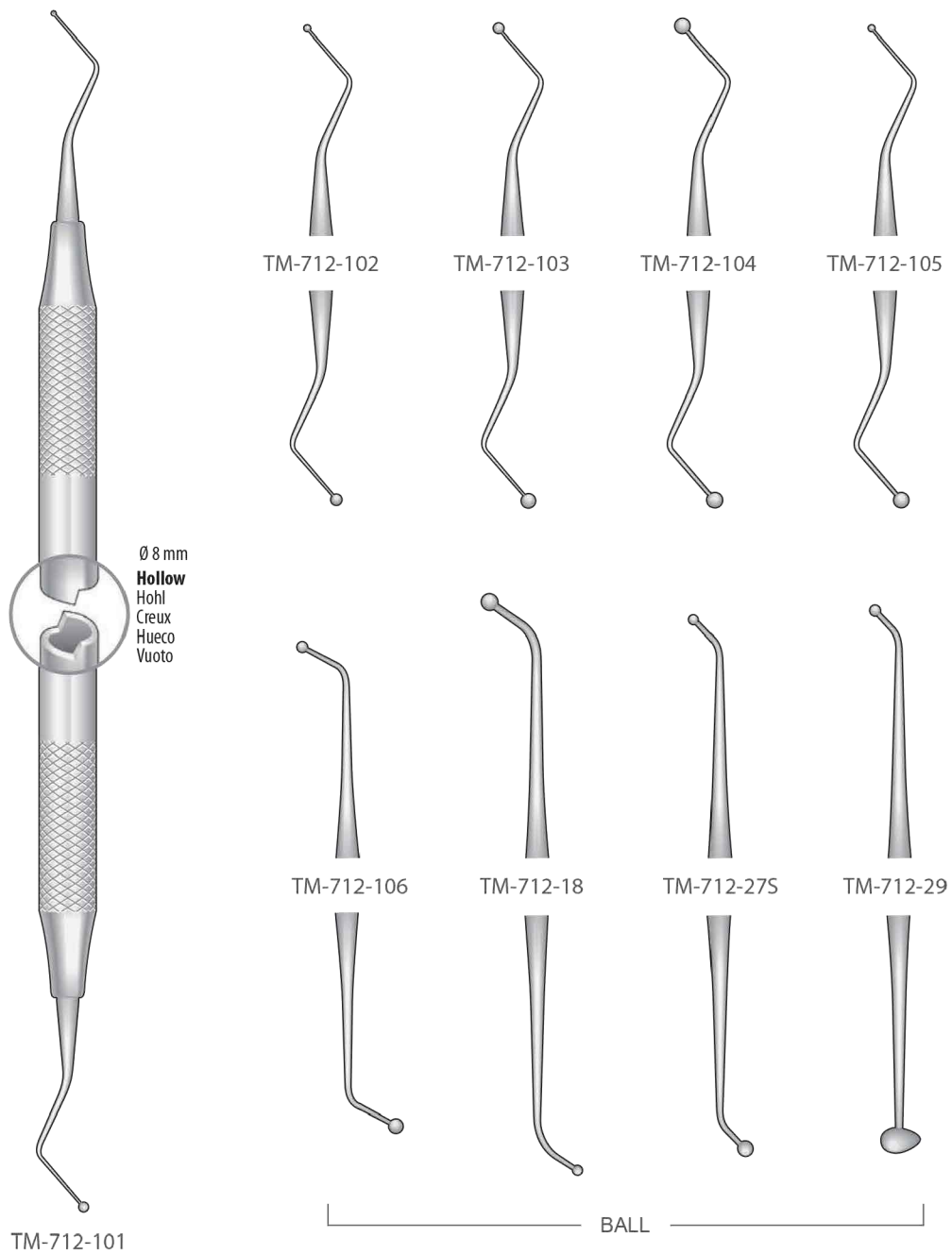
Ø 8 mm  
**Hollow**  
 Hohl  
 Creux  
 Hueco  
 Vuoto



IPC Fig. 1  
 TM-715-311  
 Interproximal

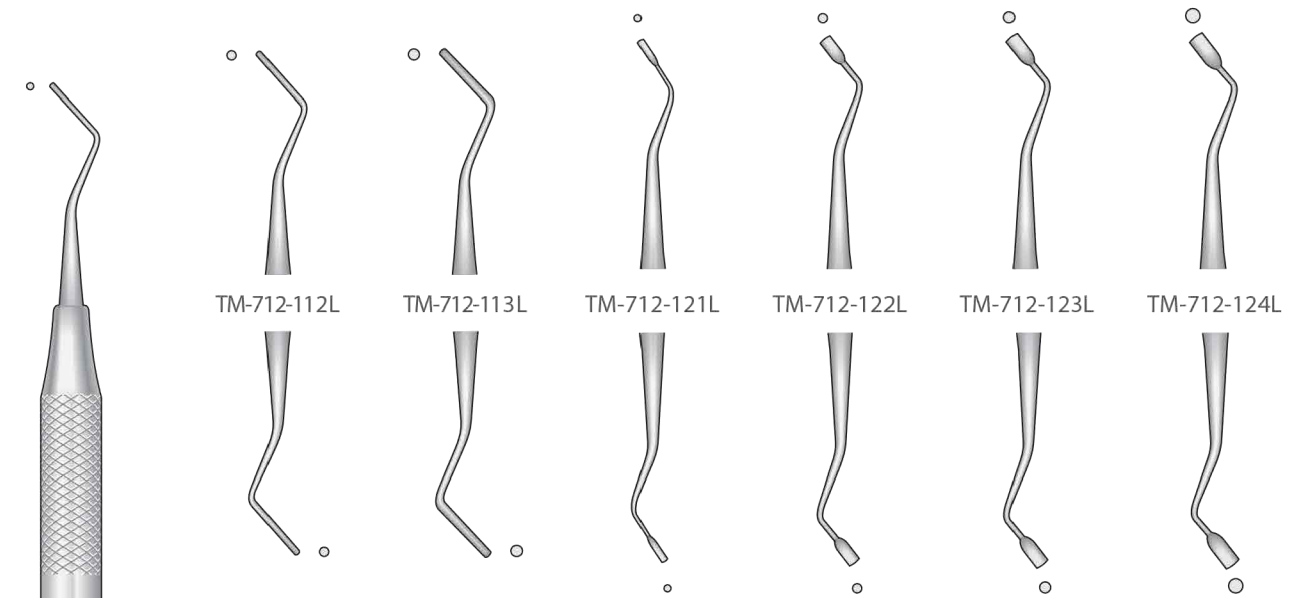


IPC/OA Fig. 2  
 TM-715-312  
 Interproximal Off-Angle



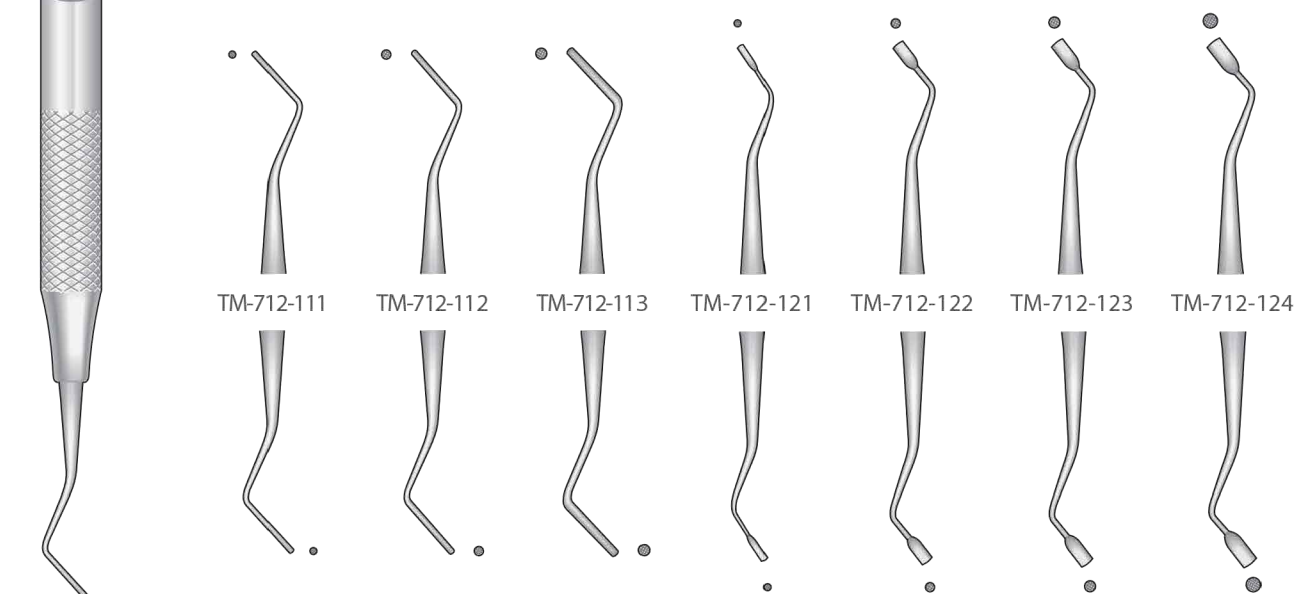
Füllungsinstrumente  
Filling Instruments  
Strumenti per otturazione  
Instrumentos para obturación  
Instruments pour obturation

Glatt - Smooth  
Lisci - Lisos  
Lissée

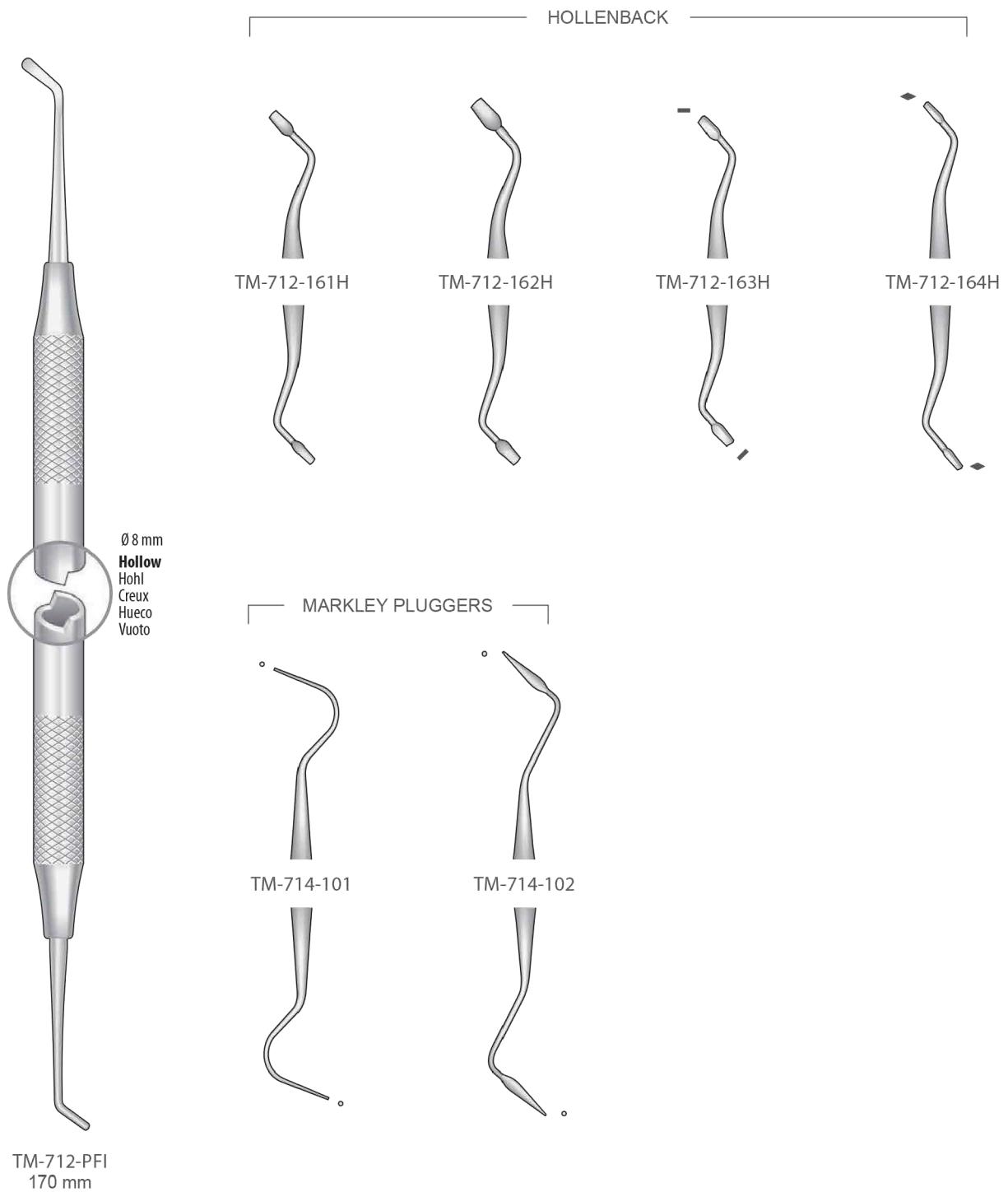


Ø 8 mm  
**Hollow**  
Hohl  
Creux  
Hueco  
Vuoto

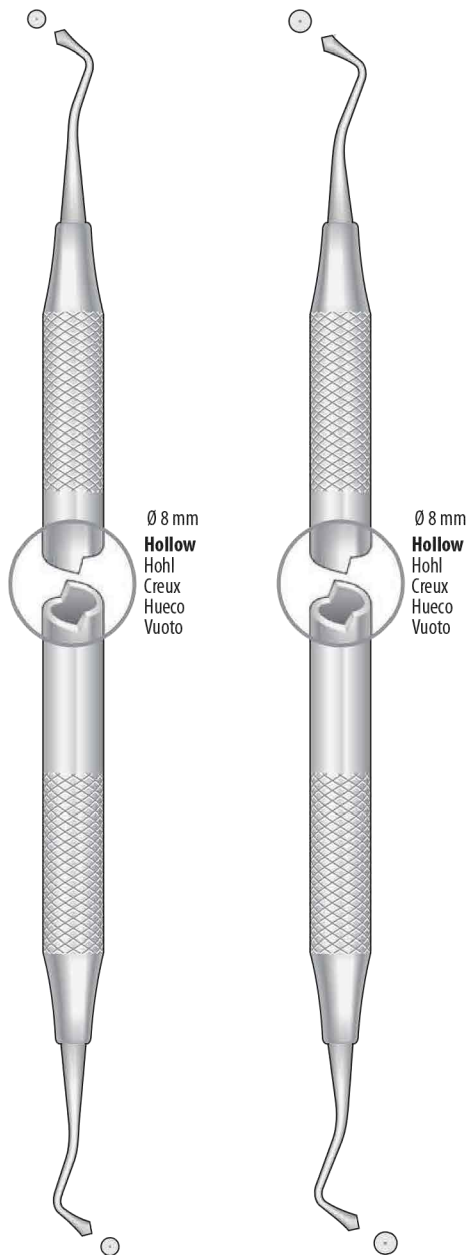
Gerieft - Serrated  
Zigrinati - Estriados  
Striés



TM-712-111L

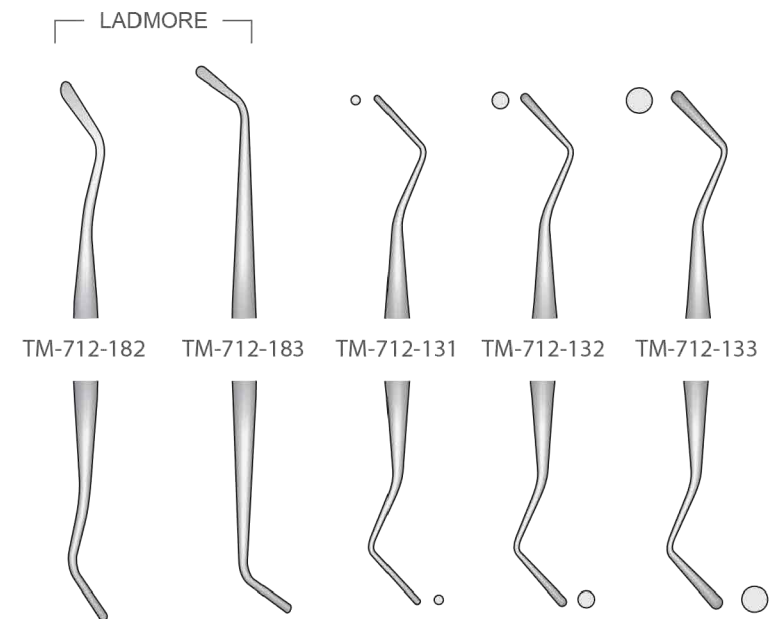
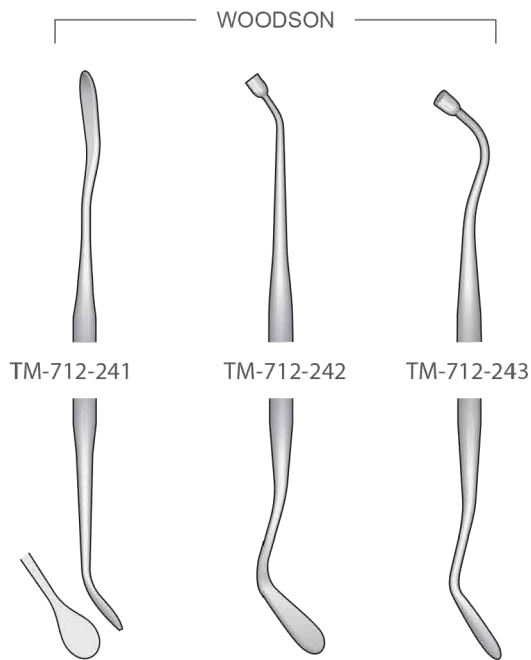


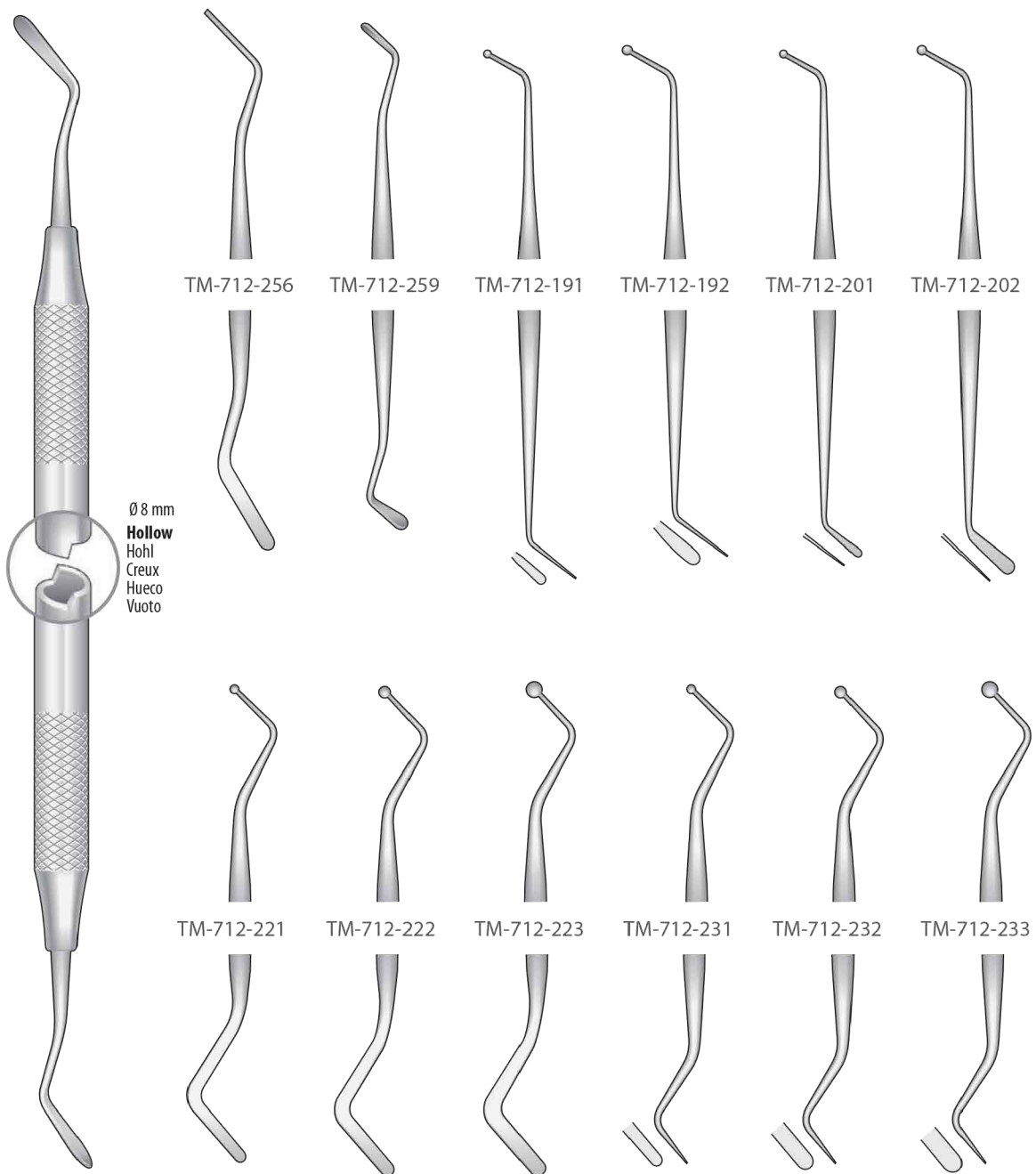
Füllungsinstrumente  
Filling Instruments  
Strumenti per otturazione  
Instrumentos para obturación  
Instruments pour obturation



WESTCOTT  
TM-712-171

WESTCOTT  
TM-712-172



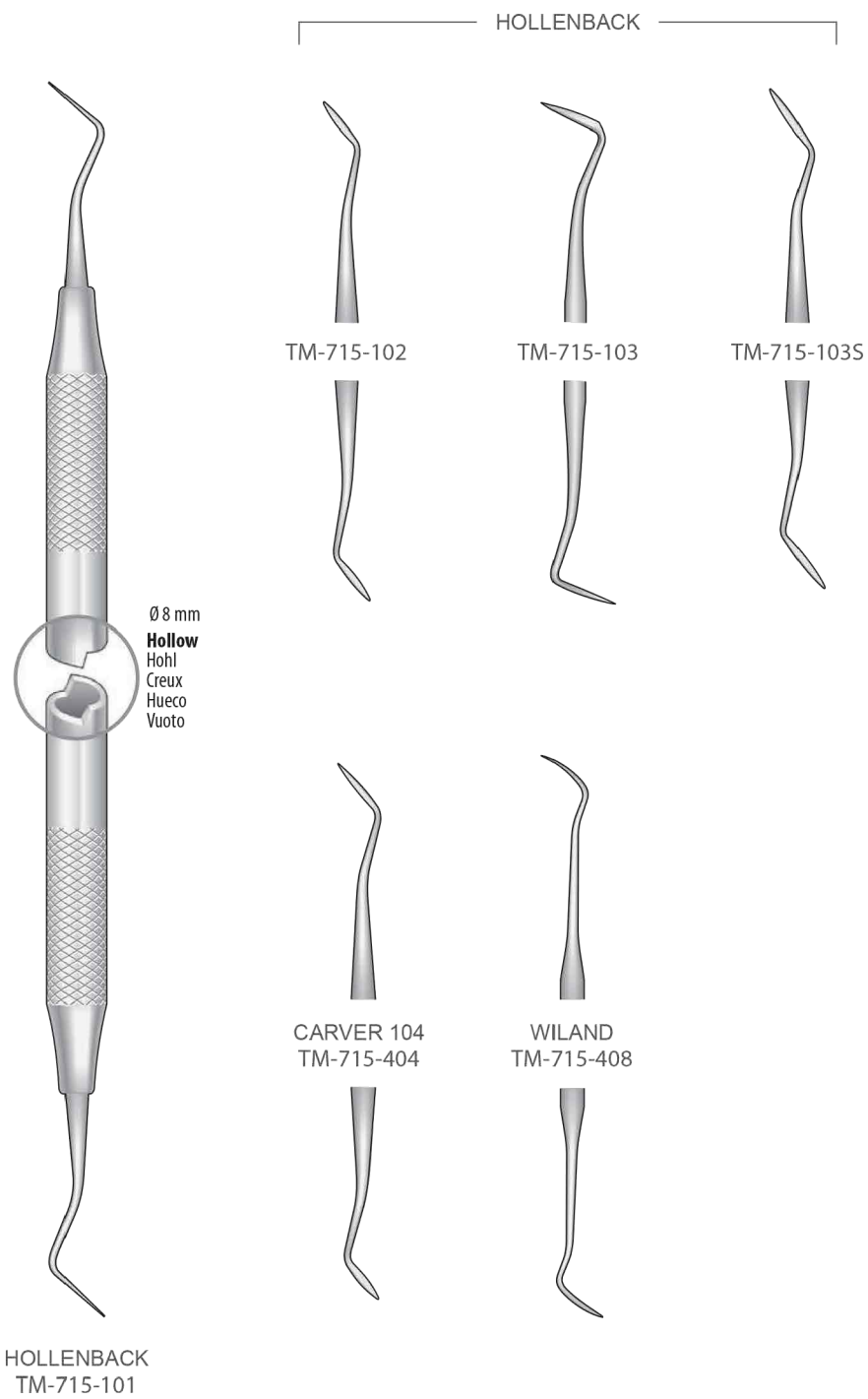


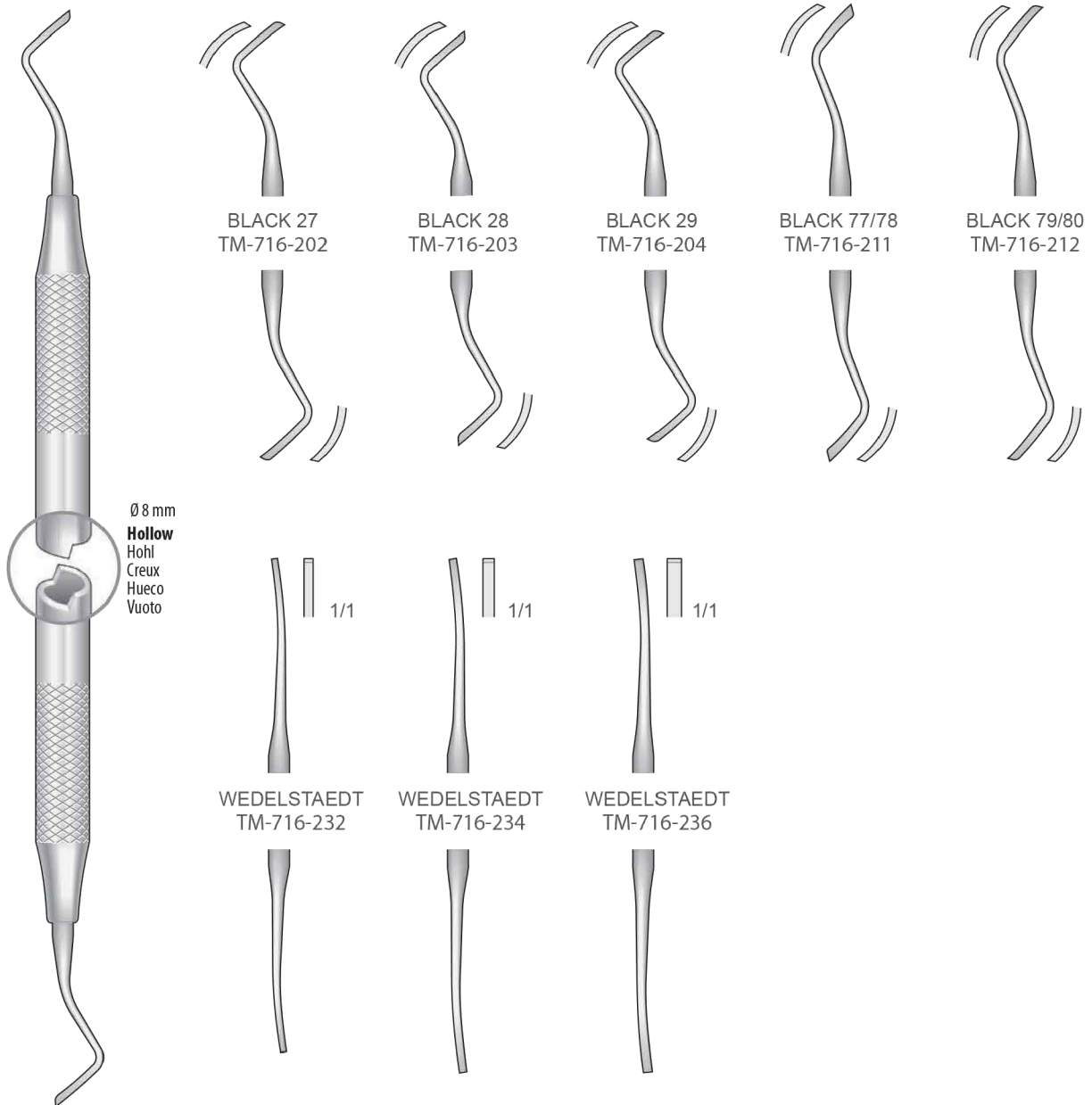
Ø 8 mm  
**Hollow**  
Hohl  
Creux  
Hueco  
Vuoto

TM-712-251



Amalgam Instrumente  
Amalgam carvers  
Strumenti per modellare otturazioni  
Instrumentos para modelar las obturaciones  
Instruments à modeler les obturations

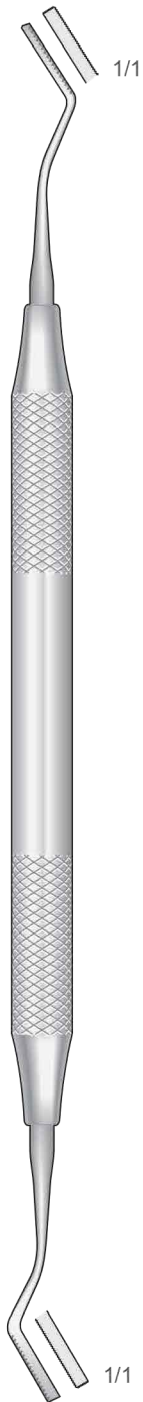




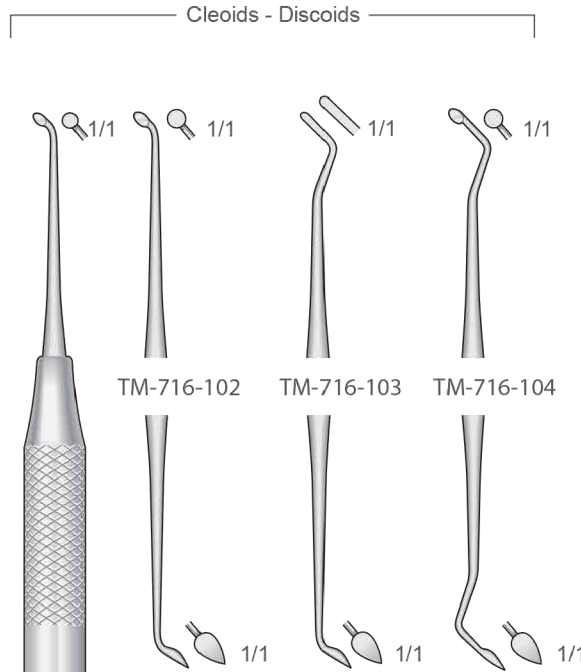
BLACK 26  
TM-716-201

Amalgam Instrumente  
Amalgam carvers  
Strumenti per modellare otturazioni  
Instrumentos para modelar las obturaciones  
Instruments à modeler les obturations

Instrument für Drahrückzug  
Instrument for Retractor wire  
Strumento per filo retrattore  
Instrumento para hilo retractor  
Instruments pour fil racteur



TM-714-CV11

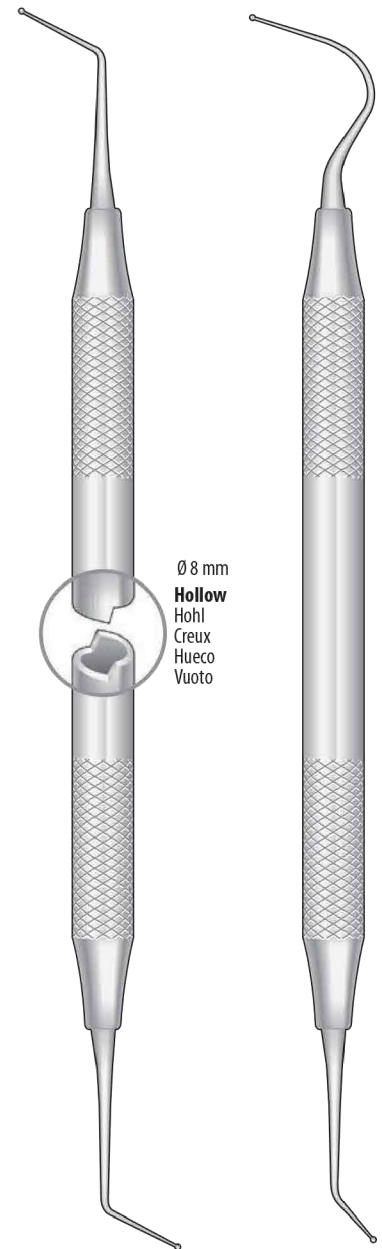


Ø 8 mm  
**Hollow**  
Hohl  
Creux  
Hueco  
Vuoto



TM-716-101

Dykal Applikator  
Placement Instruments  
Applicatori per sottofondo  
Aplicadores de fondo de cavidades  
Applicateurs de fond de cavité



Ø 8 mm  
**Hollow**  
Hohl  
Creux  
Hueco  
Vuoto

TM-713-101

TM-713-102

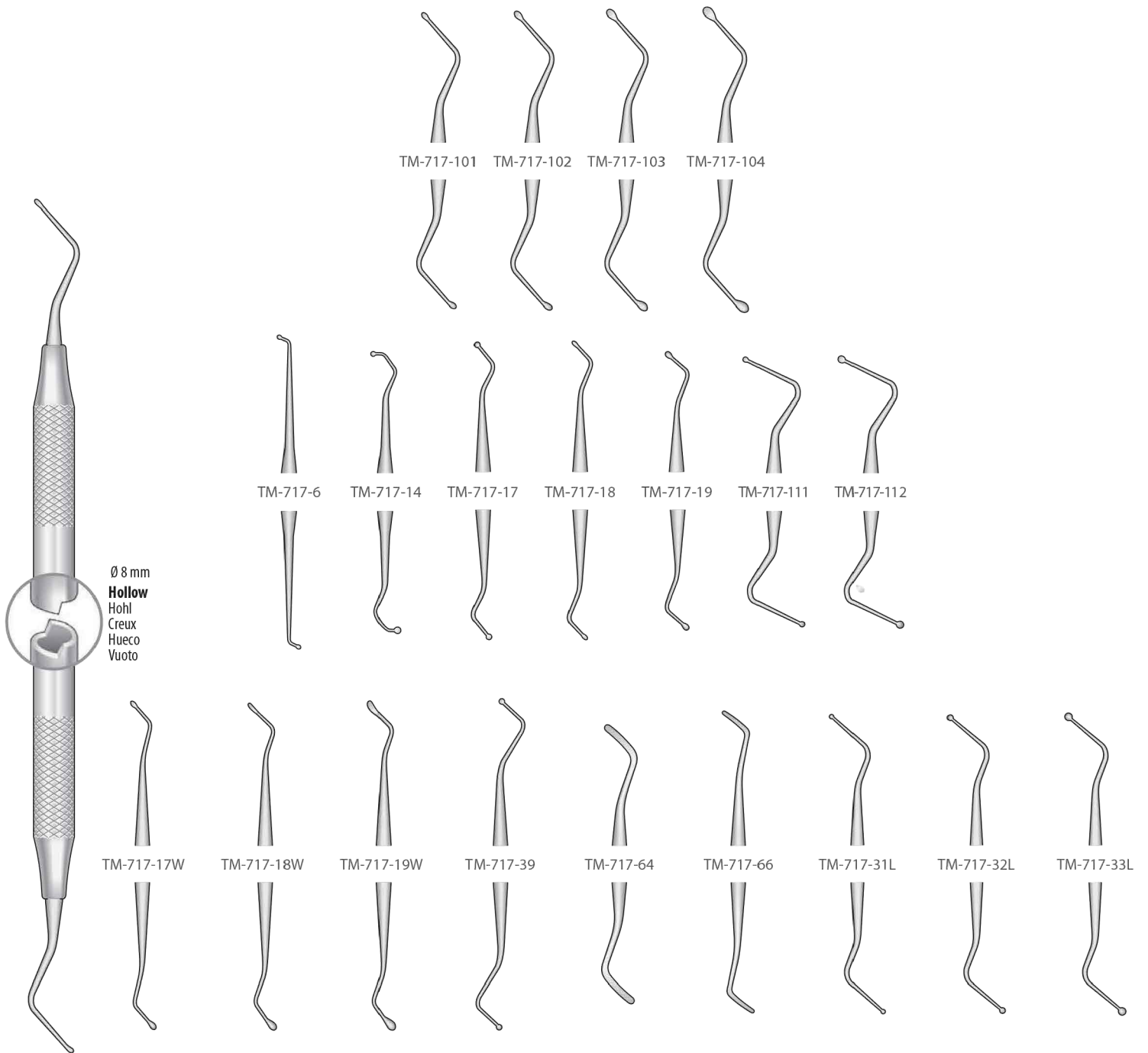
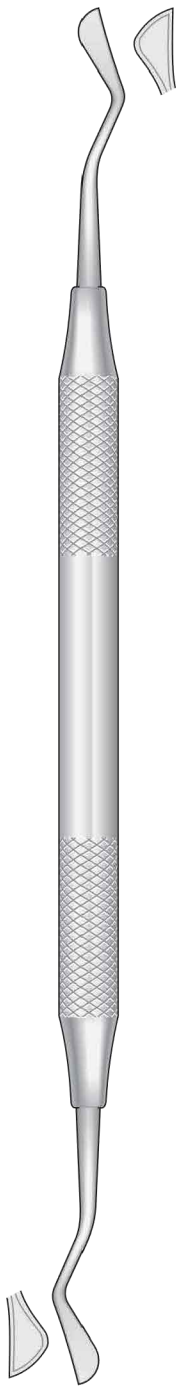


Fig. 2

TM-717-100

Parodontalmesser  
Gingivectomy knives  
Bisturi per gengivectomia  
Bisturías para la gingivectomía  
Bistouris pour la gingivectomie



KIRKLAND  
TM-718-123  
Fig. 15K/16K

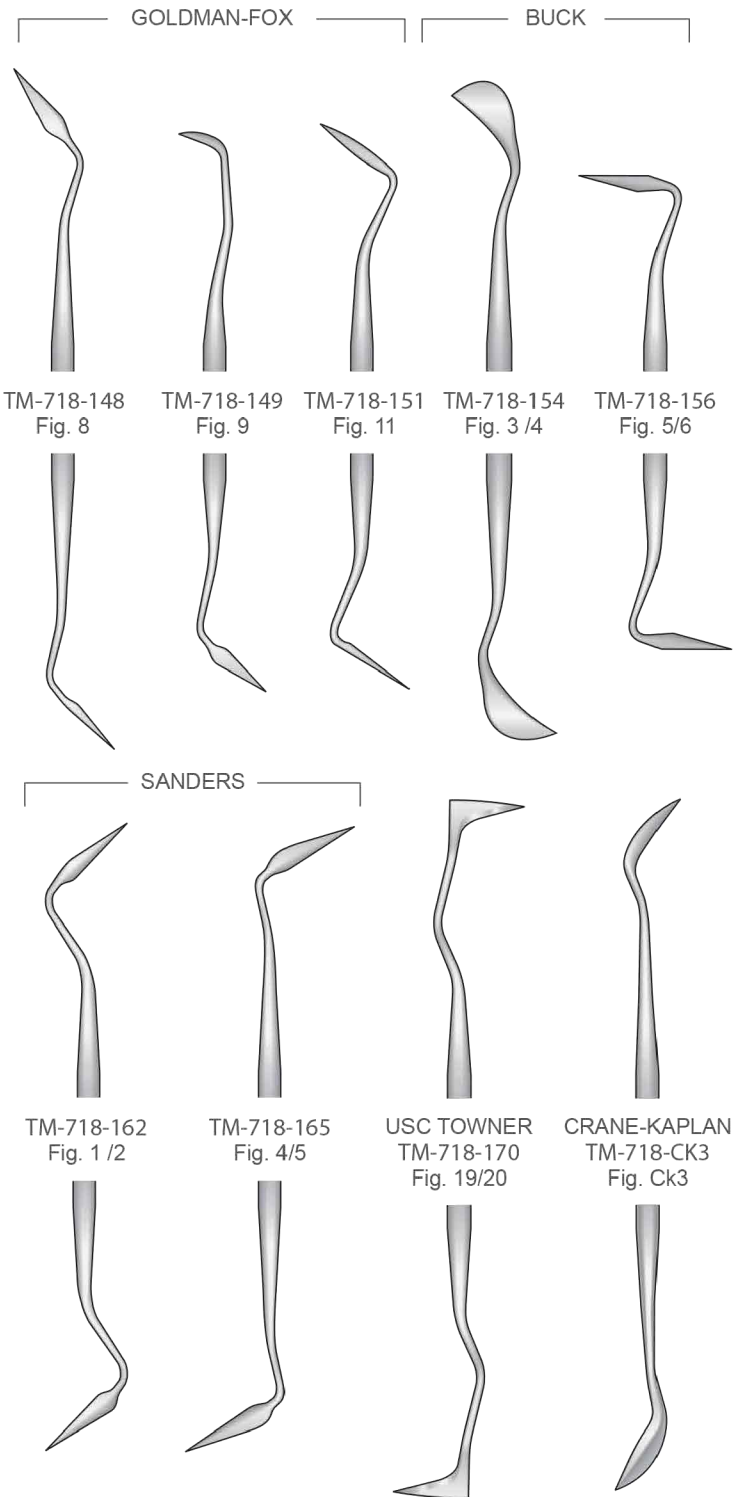


ORBAN  
TM-718-133  
Fig. 1 1/2

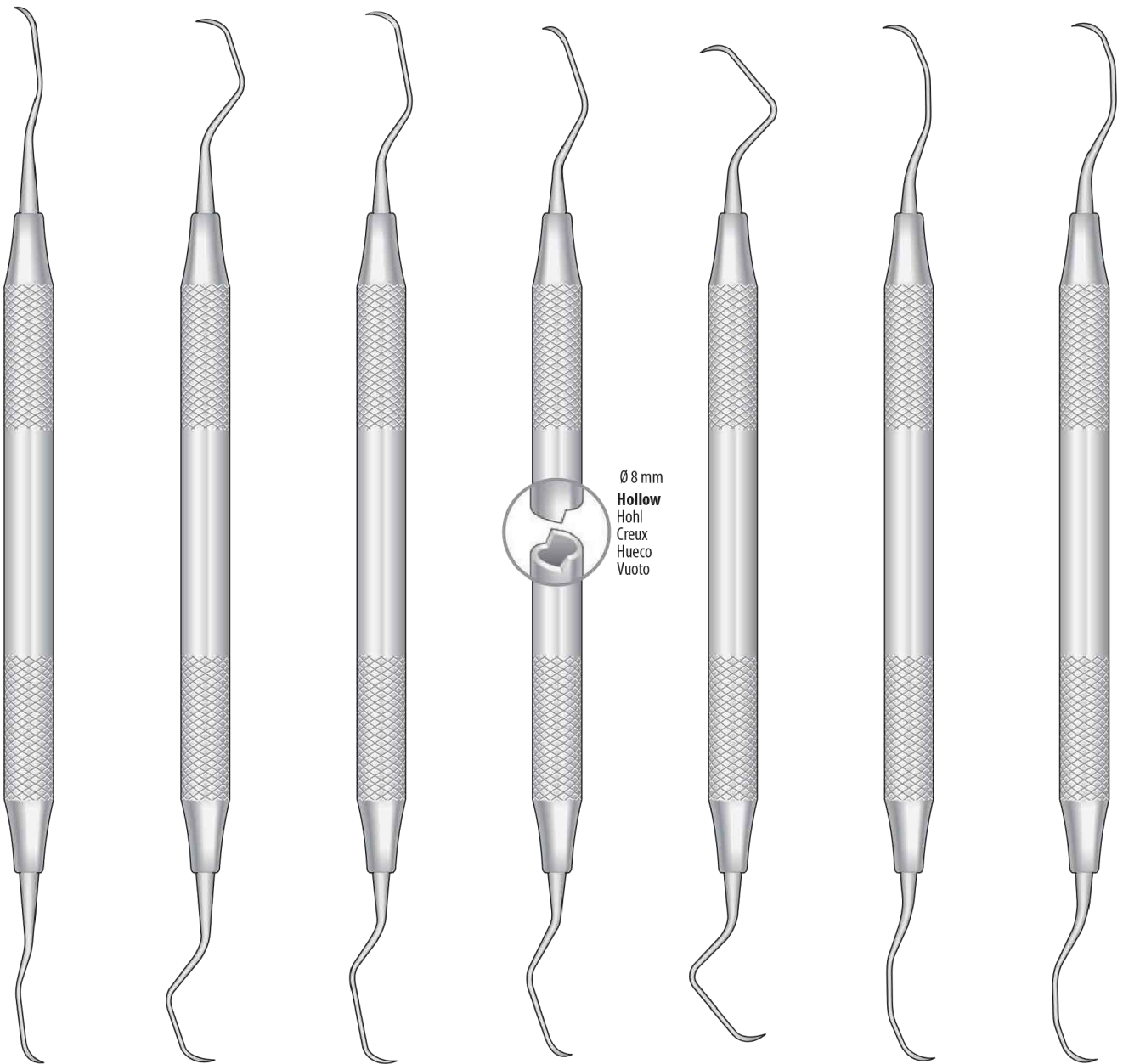
Ø 8 mm  
**Hollow**  
Hohl  
Creux  
Hueco  
Vuoto



GOLDMAN-FOX  
TM-718-147  
Fig. 7



GRACEY



Ø 8 mm  
Hollow  
Hohl  
Creux  
Hueco  
Vuoto

GRACEY  
TM-718-1/2

GRACEY  
TM-718-3/4

GRACEY  
TM-718-5/6

GRACEY  
TM-718-7/8

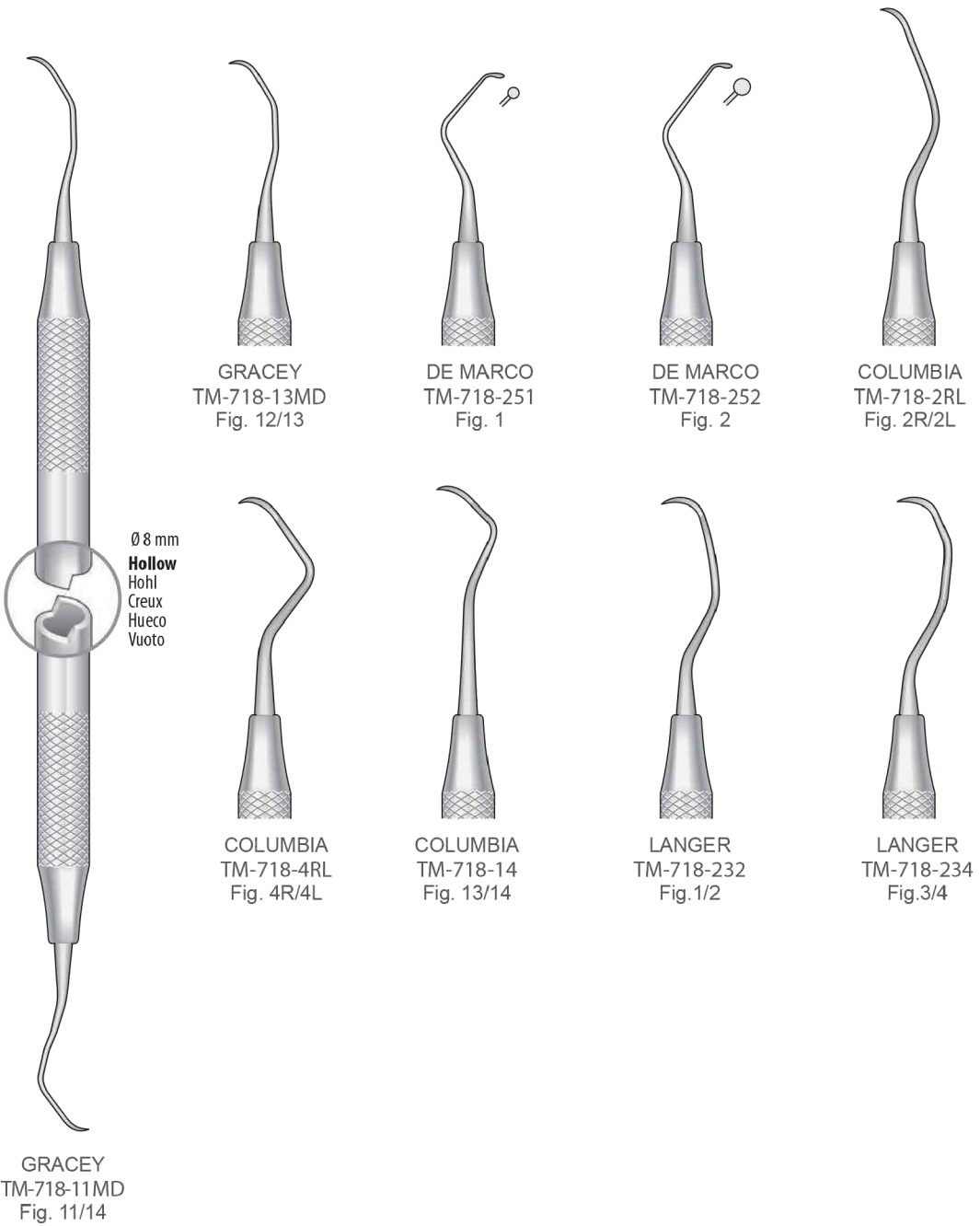
GRACEY  
TM-718-9/10

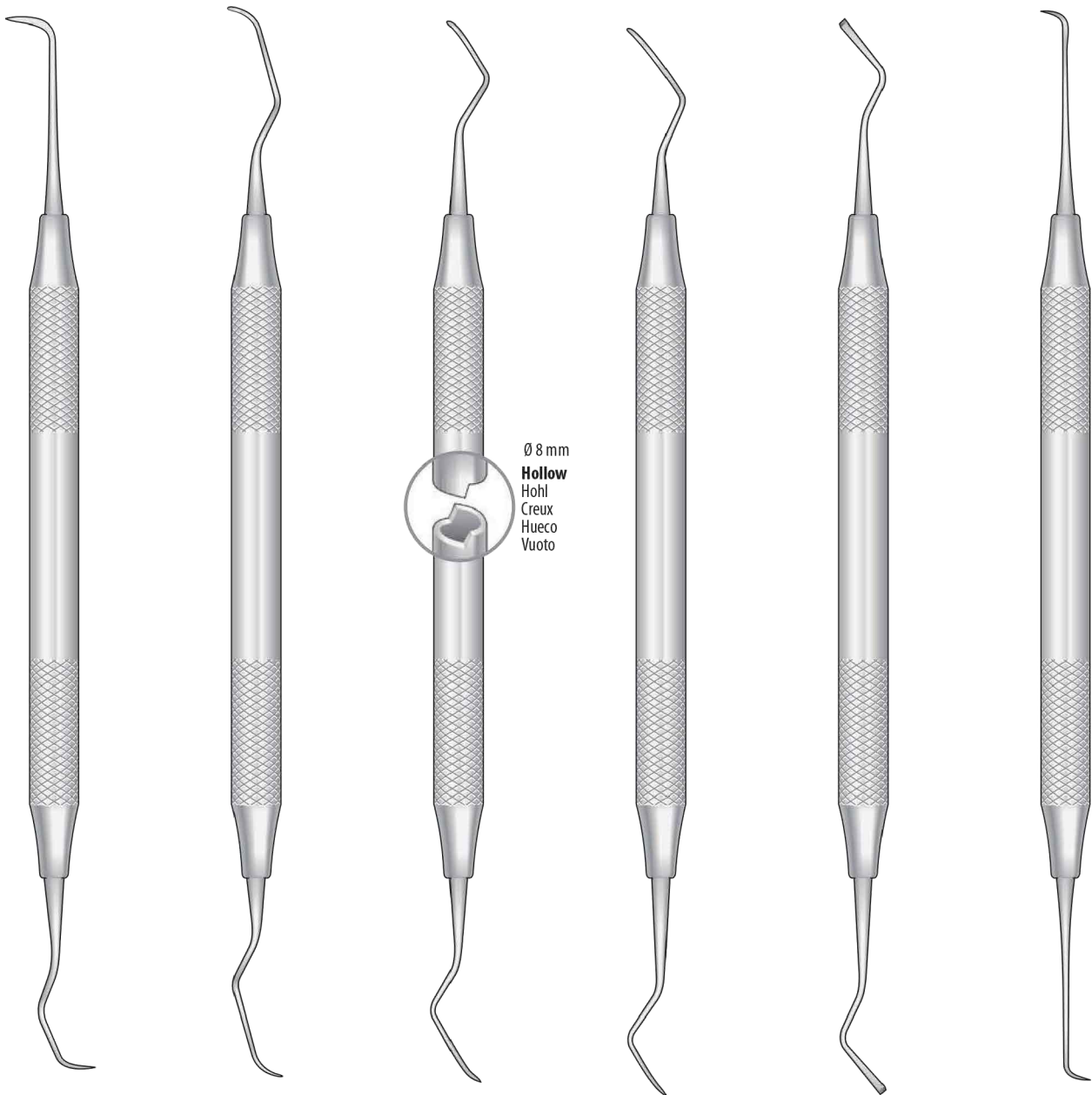
GRACEY  
TM-718-11/12

GRACEY  
TM-718-13/14

Küretten  
Curettes  
Curette  
Curetas  
Curettes

Mesial - Distal





GOLDMAN-FOX  
TM-718-271  
Fig. 1

GOLDMAN-FOX  
TM-718-272  
Fig. 2

GOLDMAN-FOX  
TM-718-273  
Fig. 3

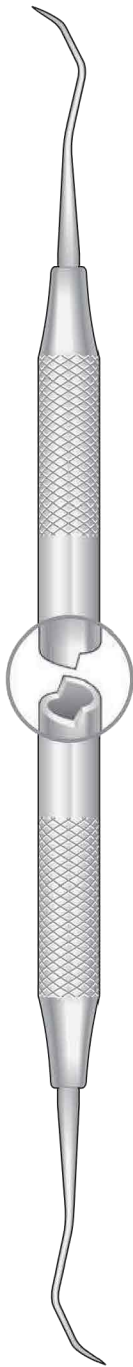
GOLDMAN-FOX  
TM-718-274  
Fig. 4

GOLDMAN-FOX  
TM-718-275  
Fig. 5

GOLDMAN-FOX  
TM-718-277  
Fig. 21



Scaler und Küretten  
Scalers and Curettes  
Scaler e Curette  
Raspadores y Curetas  
Détartreurs et Curettes

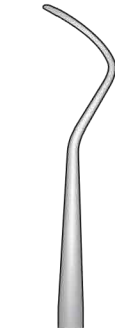


MC CALL  
TM-718-282  
Fig. 11/12

Ø 8 mm  
**Hollow**  
Hohl  
Creux  
Hueco  
Vuoto



MC CALL  
TM-718-282A  
Fig. 11A/12A



MC CALL  
TM-718-284  
Fig. 13/14



MC CALL  
TM-718-284S  
Fig. 13S/14S



MC CALL  
TM-718-288S  
Fig. 17S/18S



JAQUETTE  
TM-718-333  
Fig. 30/33

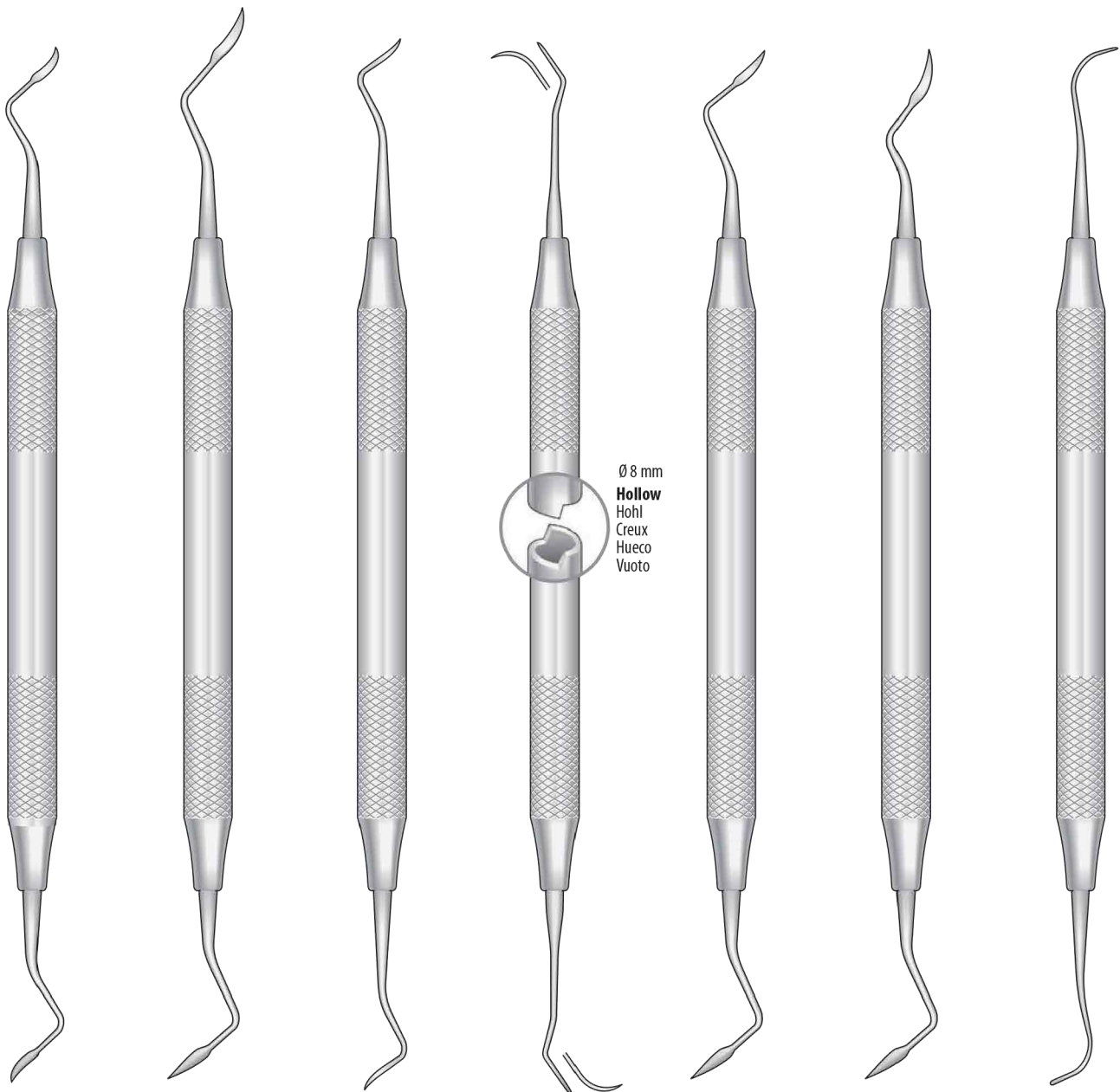


JAQUETTE  
TM-718-332  
Fig. 31/32



JAQUETTE  
TM-718-335  
Fig. 34/35





Ø 8 mm  
**Hollow**  
Hohl  
Creux  
Hueco  
Vuoto

TAYLOR  
TM-718-TO3  
Fig. 2/3

TM-718-204  
Fig. 204

TM-718-204S  
Fig. 204S

TM-718-204SD  
Fig. 204SD

TM-718-CIO3  
Fig. 2/3

CRANE-CAPLAN  
TM-718-CK6  
Fig. 6

YOUNGER-GOOD  
TM-718-YGO8  
Fig. 7/8

Scaler und Küretten  
Scalers and Curettes  
Scaler e Curette  
Raspadores y Curetas  
Détartreurs et Curettes



RULE 23/24  
TM-718-RO4  
Fig. 3 /4



I. UNIVERSITY  
TM-718-268  
Fig. 17/18



TOWNER-JAQUETTE  
TM-719-111  
Fig. U15/33

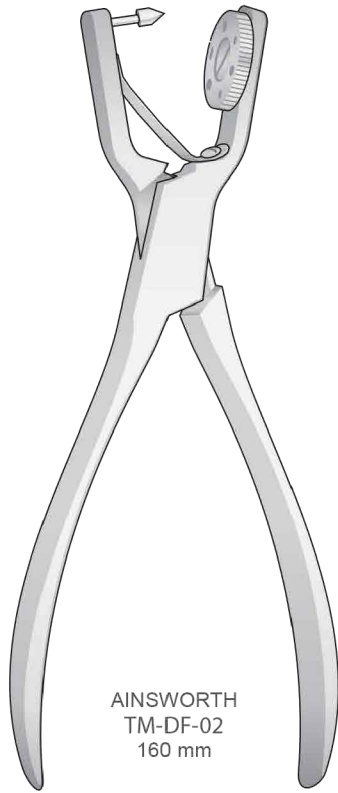
Ø 8 mm  
**Hollow**  
Hohl  
Creux  
Hueco  
Vuoto



TOWNER-JAQUETTE  
TM-719-125  
Fig. H5/33



TOWNER-JAQUETTE  
TM-719-126  
Fig. H6/H7



AINSWORTH  
TM-DF-02  
160 mm

Lochzangen  
Punch Forceps  
Pinze foradiga  
Perforadores  
Pinces à perforer



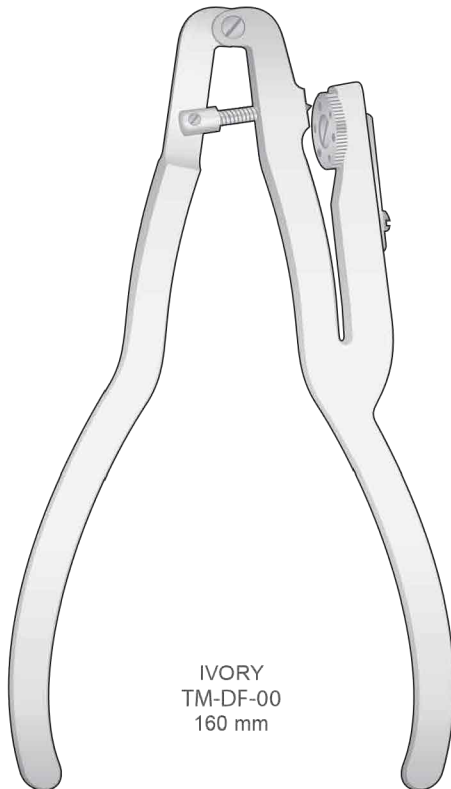
TM-DF-02M  
Feder mit Schraube  
Spring with screw  
Molla con vite  
Muelle con tornillo  
Ressort avec vis



TM-DF-02R  
Lochscheibe  
Punch Disk  
Disco divisore  
Disco agujereado  
Disque perforé



TM-DF-02P  
Stift, mit Schraube  
Pin, with screw  
Perno con vite  
Punzòn con perno  
Broche



IVORY  
TM-DF-00  
160 mm

Lochzangen  
Punch Forceps  
Pinze foradiga  
Perforadores  
Pinces à perforer



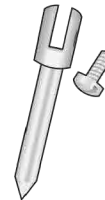
TM-DF-00M  
Spiralfeder  
Spiral Spring  
Molla a spirale  
Muelle espiral  
Ressort en spirale



TM-DF-00L + TM-DF-00V  
Feder mit Schraube  
Spring with screw  
Molla con vite  
Muelle con tornillo  
Ressort avec vis

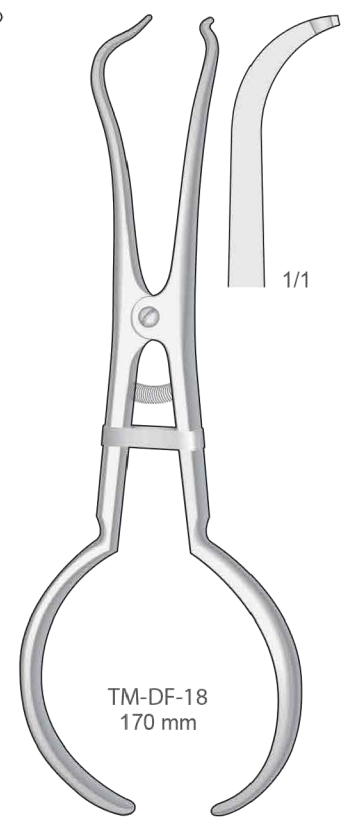
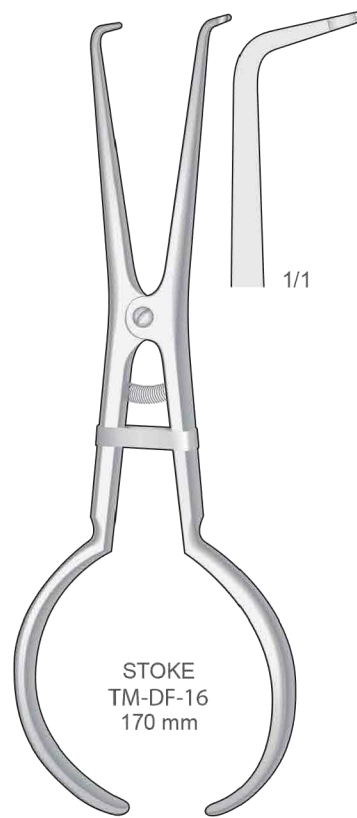
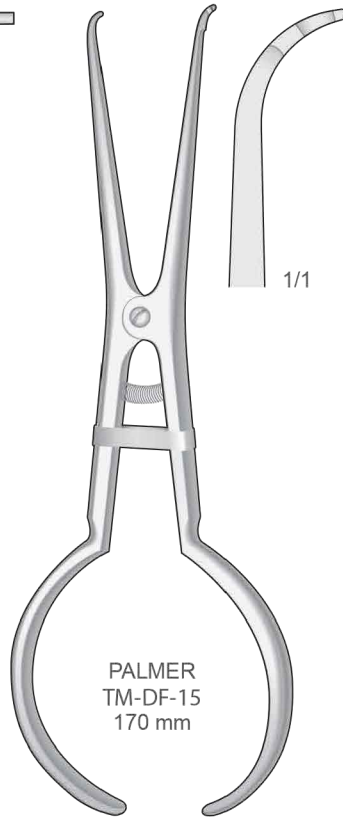
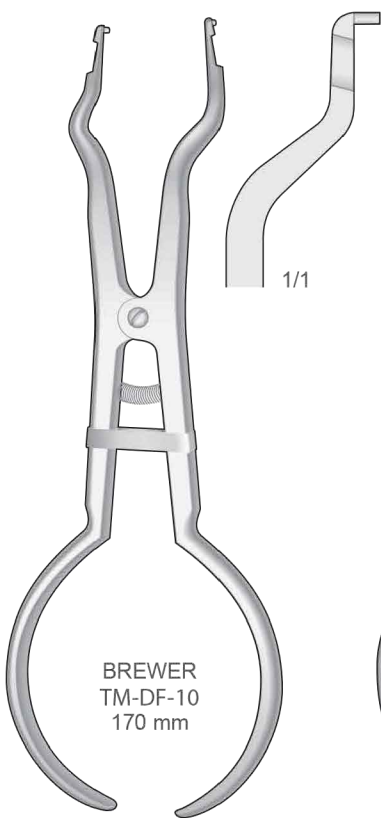


TM-DF-00R  
Lochscheibe  
Punch Disk  
Disco divisore  
Disco agujereado  
Disque perforé



TM-DF-00P + TM-DF-00N  
Stift, mit Schraube  
Pin, with screw  
Perno con vite  
Punzòn con perno  
Broche avec vis

Kofferdam-Klammerzangen  
Rubber-Dam Clamp Forceps  
Pinze per uncini  
Pinzas para grapas dique de goma  
Pinces porte-crampons



Molaren, 12 Stück  
Molars, 12 pieces  
Molari, 12 pezzi  
Molares, 12 piezas  
Molaires, 12 Pièces

Premolaren, 12 Stück  
Premolars, 12 pieces  
Premolari, 12 pezzi  
Premolares, 12 piezas  
Prémolaires, 12 Pièces



TM-DF-40/1  
Fig.1



TM-DF-41/4  
Fig.4



TM-DF-40/2  
Fig.2



TM-DF-41/5  
Fig.5

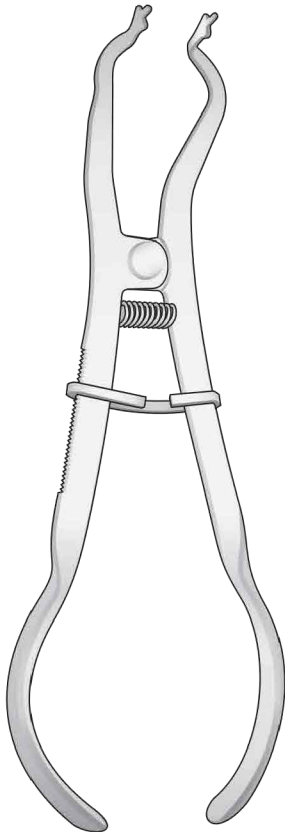


TM-DF-40/3  
Fig.3

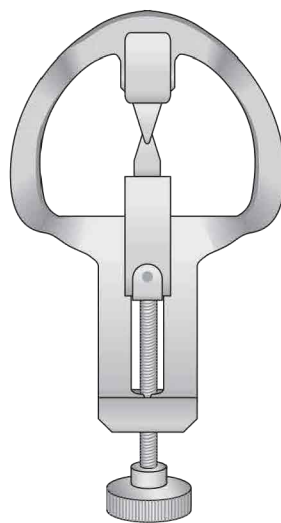


TM-DF-41/6  
Fig.6

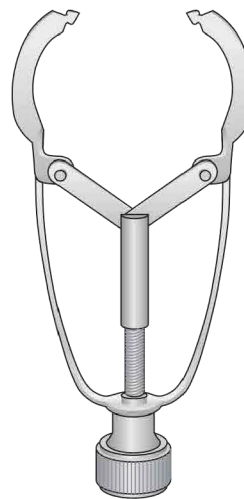
Kofferdam-Klammerzangen  
Rubber-Dam Clamp Forceps  
Pinze per uncini  
Pinzas para grapas dique de goma  
Pinces porte-crampons



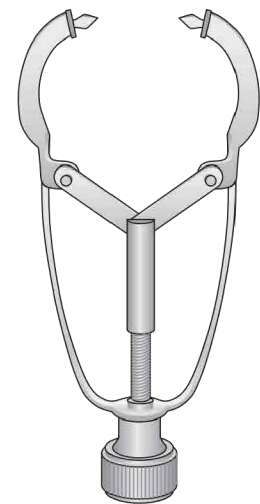
IVORY  
TM-DF-12  
170 mm



IVORY  
TM-DF-43  
Fig. 14



IVORY  
TM-DF-40  
Fig. 1



IVORY  
TM-DF-41  
Fig. 12

Kofferdam Instrumente  
Rubber-Dam Instruments  
Strumenti per diga  
Instrumentos para dique de goma  
Instruments pour digue de caoutchouc

Kofferdam-Klammern  
Rubber-Dam Clamps  
Uncini per diga  
Clamps para diques  
Crampons pour digue



IVORY  
TM-DF-126  
# 26



IVORY  
TM-DF-127  
# 27



IVORY  
TM-DF-128  
# 28



IVORY  
TM-DF-129  
# 29



IVORY  
TM-DF-130  
# 30



IVORY  
TM-DF-131  
# 31

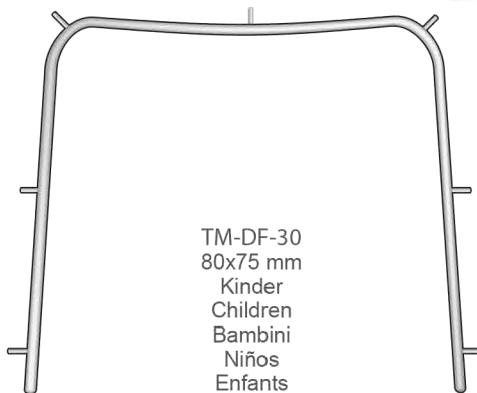


IVORY  
TM-DF-151  
# 51

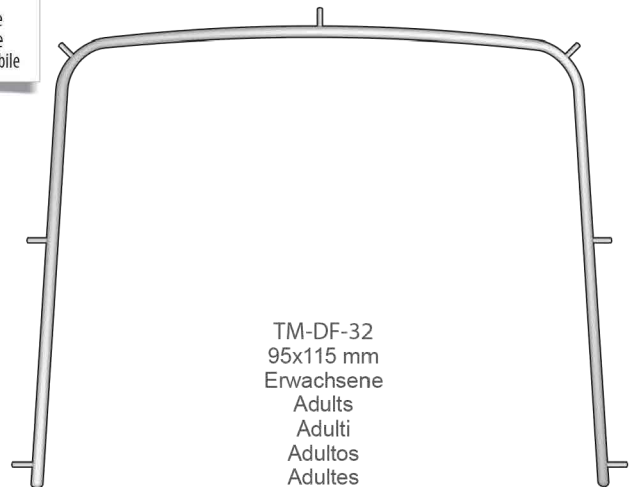


IVORY  
TM-DF-160  
# 60

Kofferdam-Rahmen  
Rubber-Dam Frames  
Telaio per diga  
Cuadro para diques  
Cadre à digue



TM-DF-30  
80x75 mm  
Kinder  
Children  
Bambini  
Niños  
Enfants

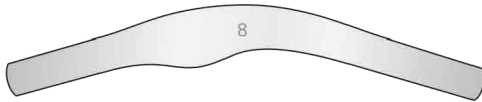


TM-DF-32  
95x115 mm  
Erwachsene  
Adults  
Adulti  
Adultos  
Adultes

Molaren, 12 Stück  
Molars, 12 pieces  
Molari, 12 pezzi  
Molares, 12 piezas  
Molaires, 12 Pièces



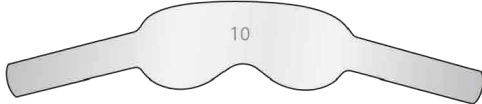
TM-DF-03/7  
#7



TM-DF-03/8  
#8



TM-DF-03/9  
#9

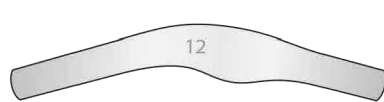


TM-DF-03/10  
#10

Premolaren, 12 Stück  
Premolars, 12 pieces  
Premolari, 12 pezzi  
Premolares, 12 piezas  
Prémolaires, 12 Pièces



TM-DF-03/11  
#11



TM-DF-03/12  
#12



TM-DF-03/13  
#13

TOFFLEMIRE  
Universal



TM-DF-03/1  
#1



TM-DF-03/2  
#2

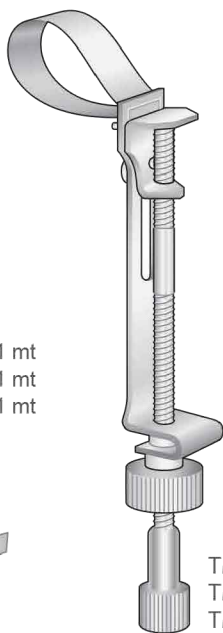


TM-DF-03/3  
#3

TM-DF-01/5 5 mm x 1 mt  
TM-DF-01/6 6 mm x 1 mt  
TM-DF-01/7 7 mm x 1 mt



TM-DF-05/5 5 mm x 5 mt  
TM-DF-05/6 6 mm x 5 mt  
TM-DF-05/7 7 mm x 5 mt



IVORY  
TM-DF-06/TM-DF-09  
#8

TM-DF-06 5 mm  
TM-DF-08 6 mm  
TM-DF-09 7 mm

Paar - Pair  
Coppia - Par  
Paire



#1  
Rechts  
Right  
Destra  
Derecha  
Droite



#2  
Links  
Left  
Sinistra  
Izquierda  
Gauche

NYSTRÖM  
TM-DF-04  
#1 + #2

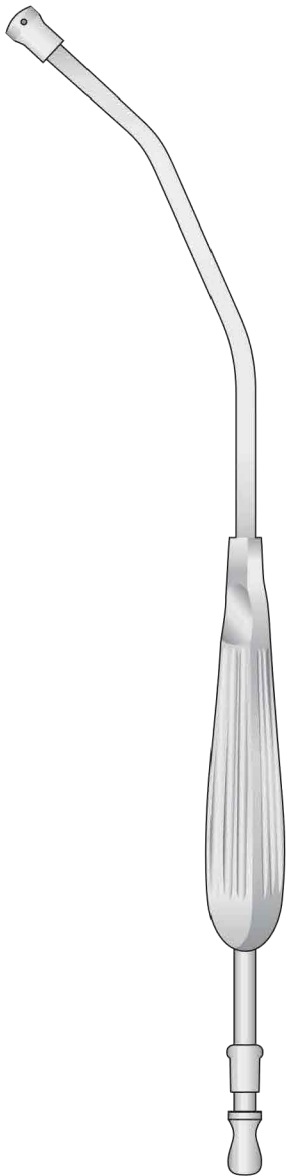


TOFFLEMIRE  
TM-DF-07  
Universal

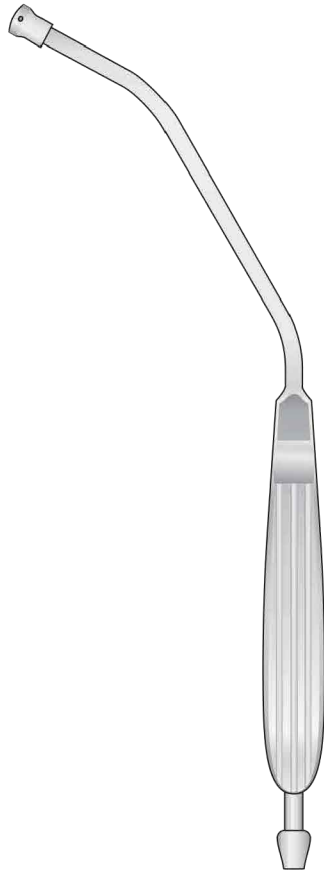


Saugkanülen  
Suction Tubes  
Cannule per aspirazione  
Cánulas de aspiración  
Canules d'aspiration

**Stainless Steel**  
Rostfreier Stahl  
Acier inoxydable  
Acero inoxidable  
Acciaio inossidabile



YANKAUER  
TM-GF-12  
310 mm



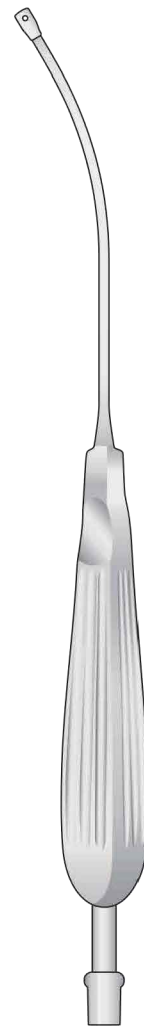
BABY-YANKAUER  
TM-GF-10  
200 mm

Ø 3 mm



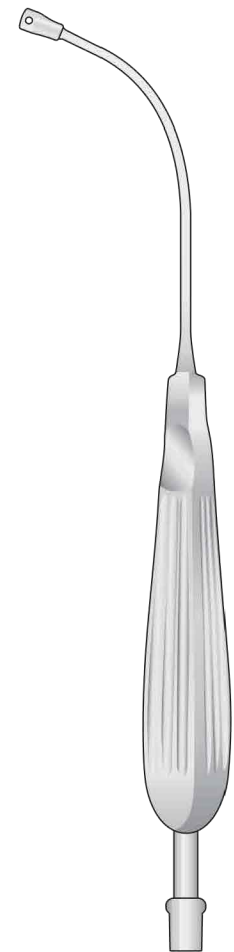
ANDREWS-PYNCHON  
TM-GF-06  
250 mm

Ø 4,2 mm



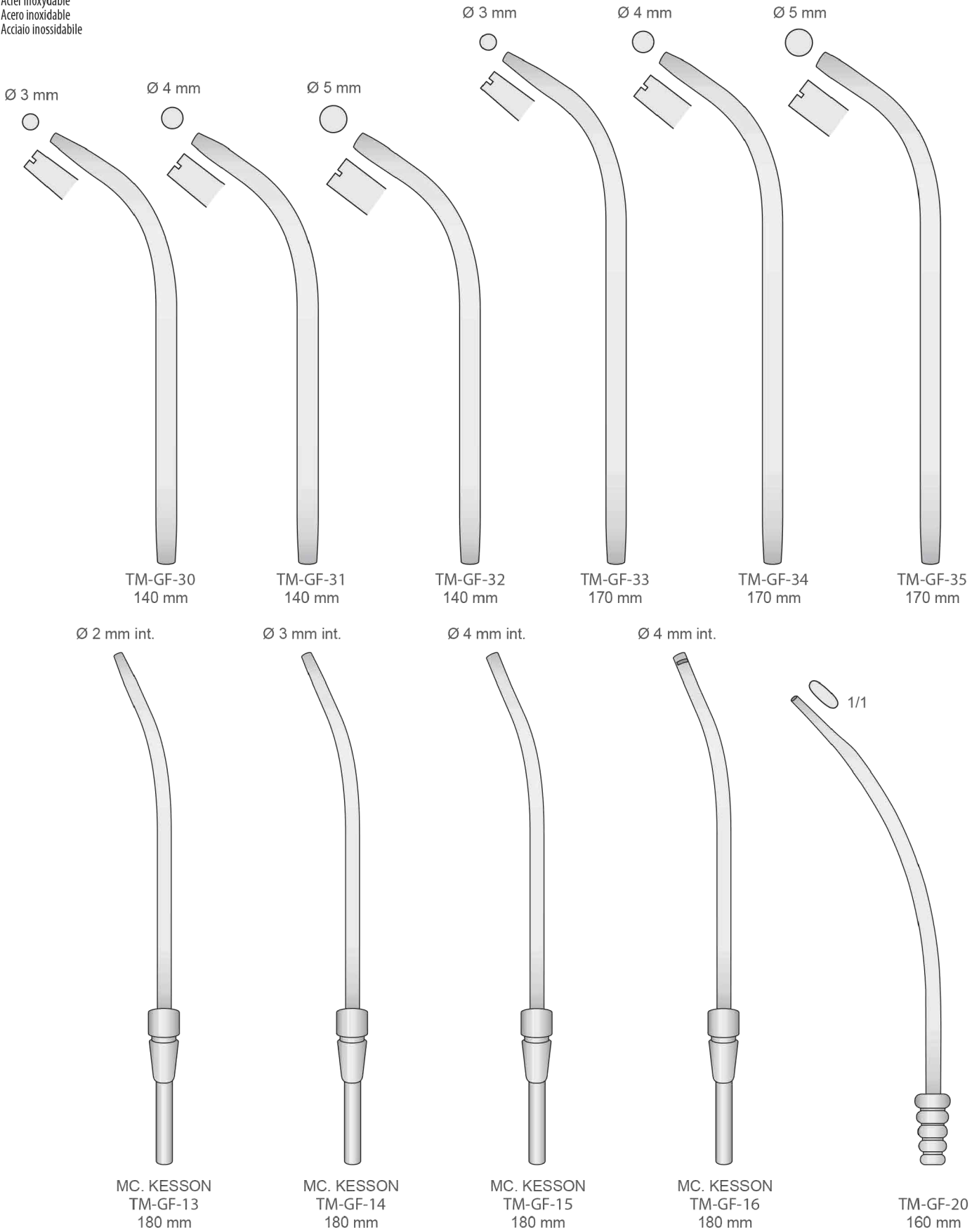
ANDREWS-PYNCHON  
TM-GF-07  
250 mm

Ø 6 mm



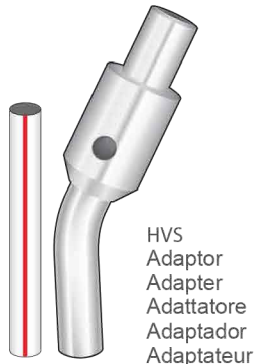
ANDREWS-PYNCHON  
TM-GF-54  
230 mm

**Stainless Steel**  
Rostfreier Stahl  
Acier inoxydable  
Acero inoxidable  
Acciaio inossidabile

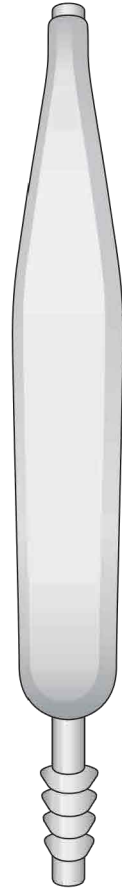


Saugkanülen  
Suction Tubes  
Cannule per aspirazione  
Cánulas de aspiración  
Canules d'aspiration

**Stainless Steel**  
Rostfreier Stahl  
Acier inoxydable  
Acero inoxidable  
Acciaio inossidabile

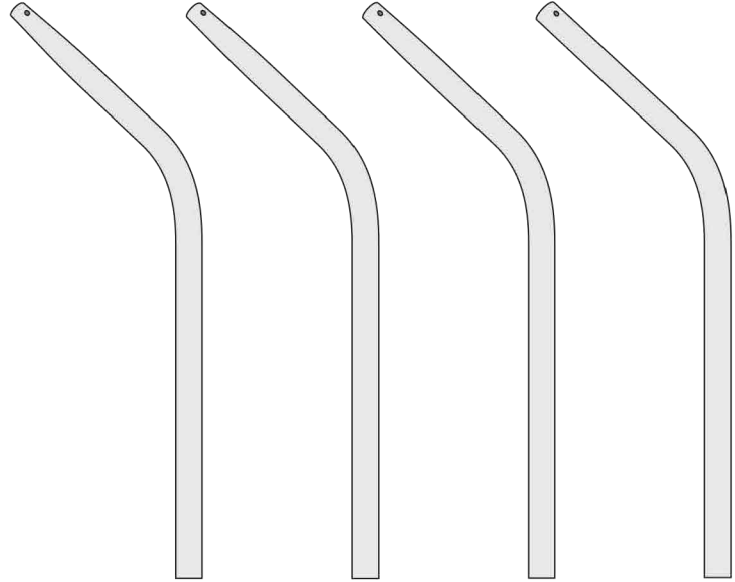


TM-TS-40  
Connection piece for suction  
75 mm - 100% Stainless Steel



COUPLAND  
TM-GF-01  
150 mm

Ø 1 mm    Ø 1,5 mm    Ø 2,5 mm    Ø 3,5 mm int.



TM-GF-05 95 mm    TM-GF-04 95 mm    TM-GF-03 95 mm    TM-GF-02 95 mm

COMPLETE SET  
TM-GF-11  
(TM-GF-01 + TM-GF-02 + TM-GF-03  
+ TM-GF-04 + TM-GF-05)  
Griff + 4 Kanülen  
Handle + 4 tubes  
Manico + 4 cannule  
Mango + 4 cánulas  
Manche + 4 canules

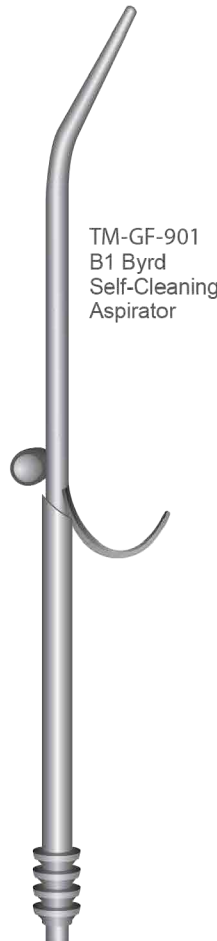
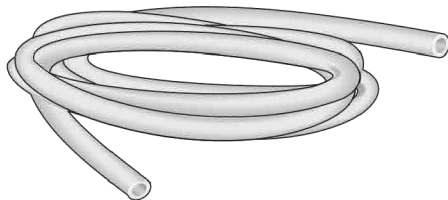


TM-GF-271  
56 mm    Adaptor  
Adapter  
Adattatore  
Adaptador  
Adaptateur

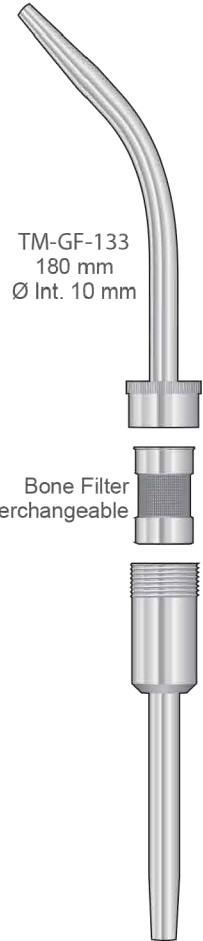
Ø Ext. 6,0 mm  
Ø Int. 4,5 mm

Autoclavable Tubing  
Schlauch - Silikon  
Flexible Tube - Silicone  
Raccordo in silicone per cannule  
Tubo flexible de silicona  
Tuyau - Silicone

TM-TS-50  
2 m



TM-GF-901  
B1 Byrd  
Self-Cleaning  
Aspirator

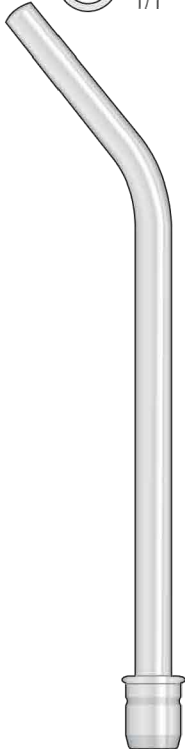


TM-GF-133  
180 mm  
Ø Int. 10 mm

Bone Filter  
interchangeable

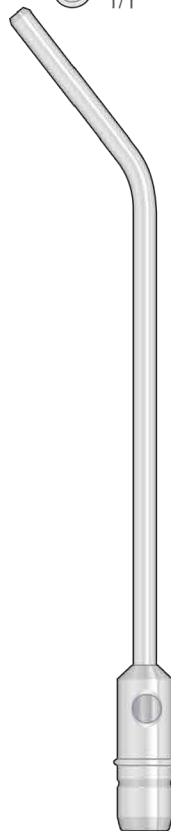
**Stainless Steel**  
Rostfreier Stahl  
Acier inoxydable  
Acero inoxidable  
Acciaio inossidabile

Ø Est. 8 mm  
Ø Int. 6 mm  
1/1

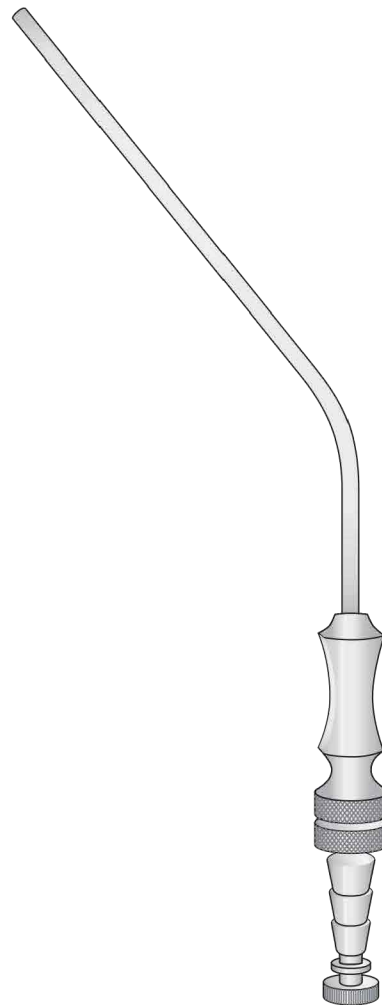


PELTON-CRANE  
TM-GF-184  
140 mm

Ø Est. 5 mm  
Ø Int. 2,5 mm  
1/1



PELTON-CRANE  
TM-GF-180  
160 mm



FRAZIER  
TM-GF-240/TM-GF-244  
180 mm

|            |        |        |
|------------|--------|--------|
| TM-GF-240  | Ch. 6  | 2.0 mm |
| TM-GF-241  | Ch. 7  | 2.3 mm |
| TM-GF-241B | Ch. 8  | 2.5 mm |
| TM-GF-242  | Ch. 9  | 3.0 mm |
| TM-GF-242B | Ch. 10 | 3.3 mm |
| TM-GF-243  | Ch. 12 | 4.0 mm |
| TM-GF-244  | Ch. 15 | 5.0 mm |

Saugkanülen  
Suction Tubes  
Cannule per aspirazione  
Cánulas de aspiración  
Canules d'aspiration

**Stainless Steel**  
Rostfreier Stahl  
Acier inoxydable  
Acero inoxidable  
Acciaio inossidabile

Flexible  
Flexibel  
Flexible  
Flexible  
Flessibile  
Ø 3 mm

Flexible  
Flexibel  
Flexible  
Flexible  
Flessibile  
Ø 3 mm

**Chromium Black**  
Schwarz-Chrom  
Chrome noir  
Cromado negro  
Cromato nero

WERTHEIMER  
TM-GF-69  
160 mm

FRAZIER  
TM-GF-70  
160 mm

FRAZIER  
TM-GF-61  
200 mm

WERTHEIMER  
TM-GF-60  
200 mm

ADSON  
TM-GF-41 ch. 12 Ø 4 mm  
TM-GF-42 ch. 15 Ø 5 mm  
210 mm

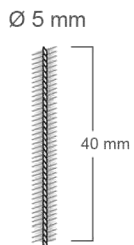
Kanülenreinigungs-Bürsten  
Cleaning brush for Tubes  
Scovolini per pulizia cannule  
Cepillo para limpiar cánulas  
Brosse de nettoyage pour canules



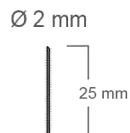
Bürsten  
Brush  
Spazzola  
Cepillo  
Brosse

Autoklav  
Autoclavable  
Autoclavabile  
Autoclave  
Autoclave

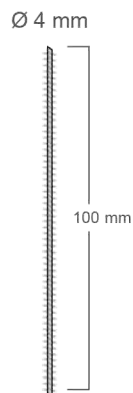
TM-GF-200  
4 x 11 cm



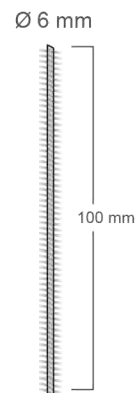
TM-GF-40  
235 mm



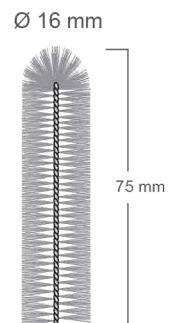
TM-GF-182  
215 mm



TM-GF-183  
300 mm

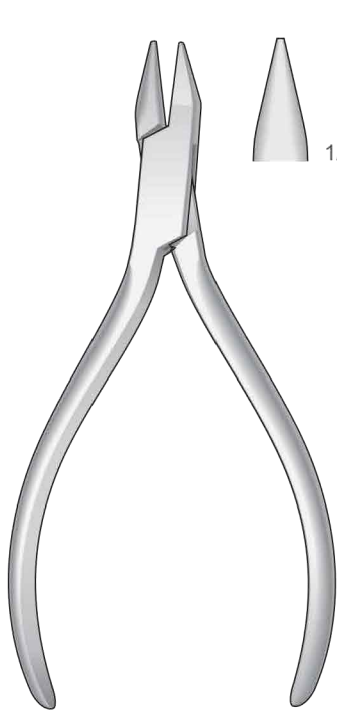


TM-GF-185  
300 mm

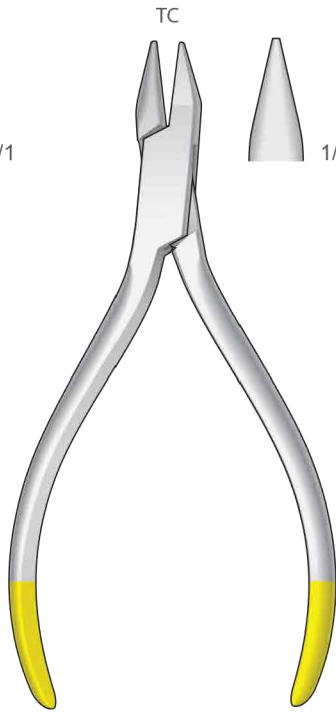


TM-GF-188  
220 mm

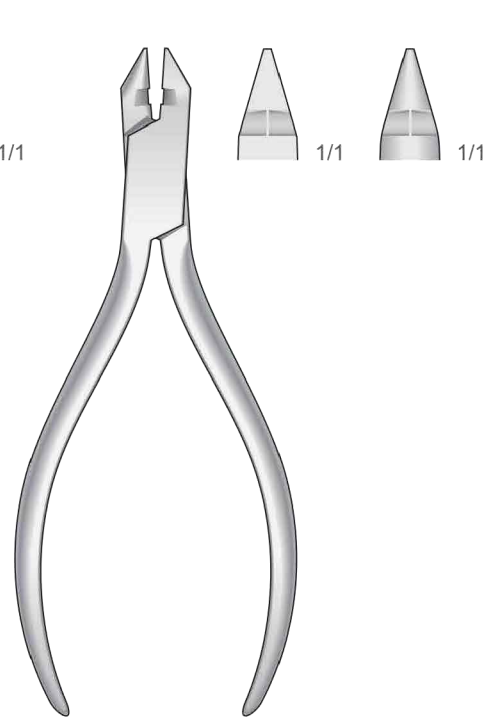
Drahtbiegezaugen  
Wire Bending Pliers  
Pinze per piegare fili  
Alicates para doblar alambres  
Pincas à pliers les fils



TM-DP-118  
130 mm

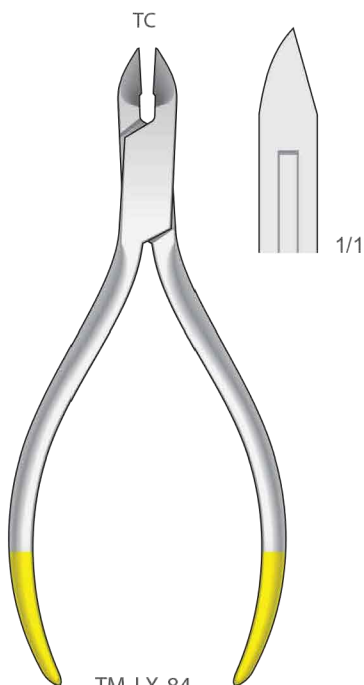


TM-DP-119  
130 mm

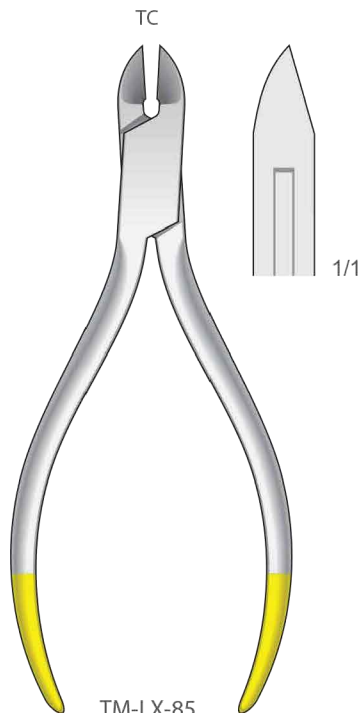


TM-DP-121  
130 mm

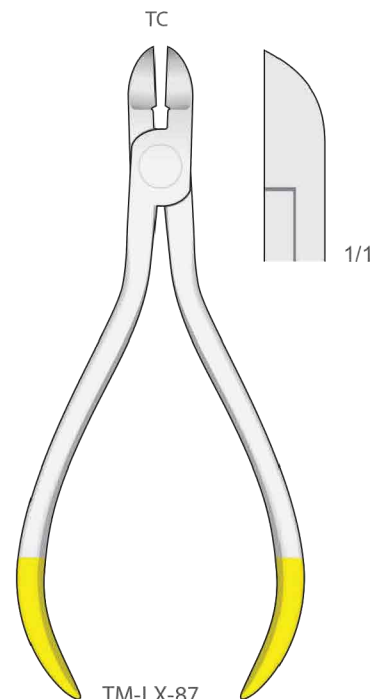
**Tungsten-Carbide Inserts**  
Mit Hartmetalleinsätzen  
Plaquettes en carbure de tungstène  
Plaquetas de carburo de tungsteno  
Inserti in carburo di tungsteno



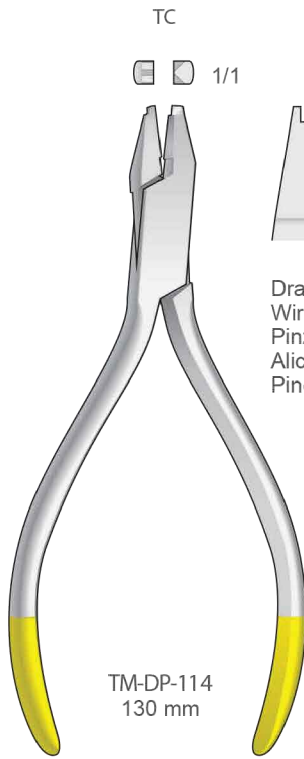
TM-LX-84  
125 mm



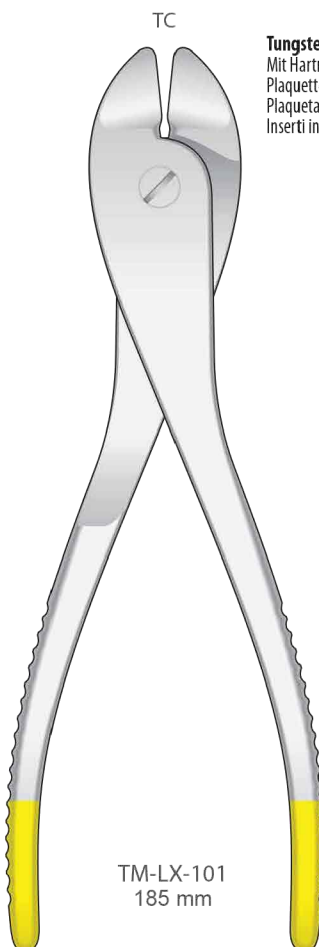
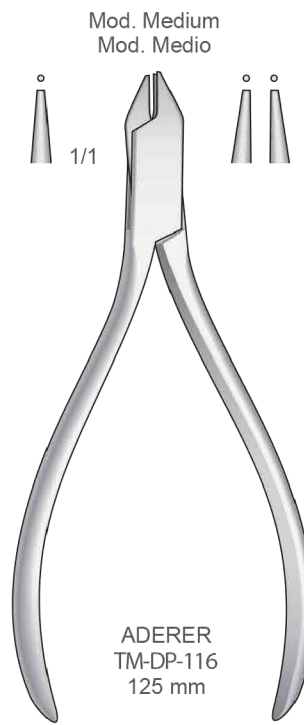
TM-LX-85  
130 mm



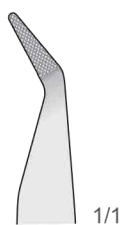
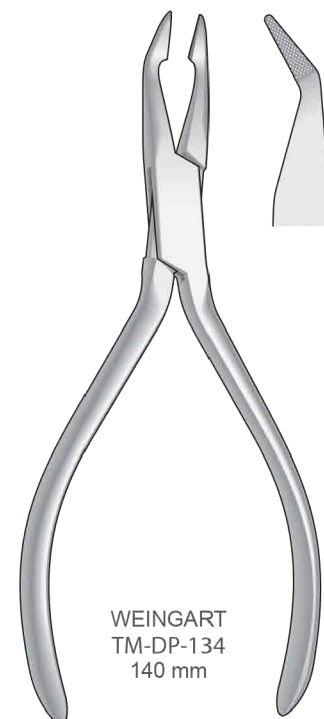
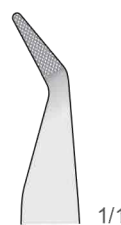
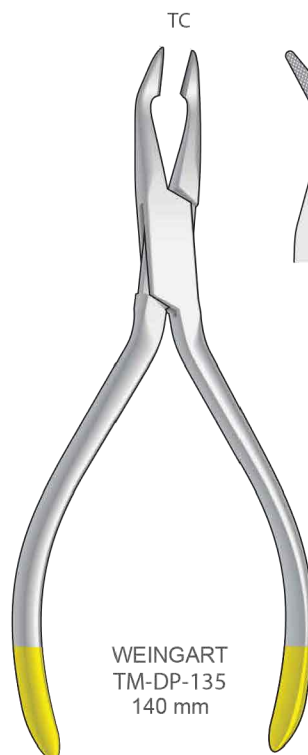
TM-LX-87  
125 mm



Drahtbiegezaugen  
Wire Bending Pliers  
Pinze per piegare fili  
Alicates para doblar alambres  
Pincas à pliers les fils

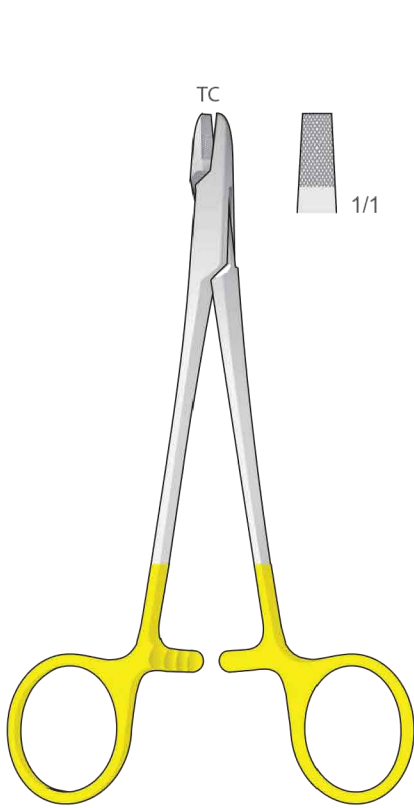


**Tungsten-Carbide Inserts**  
Mit Hartmetalleinsätzen  
Plaquettes en carbure de tungstène  
Plaquetas de carburo de tungsteno  
Inserti in carburo di tungsteno

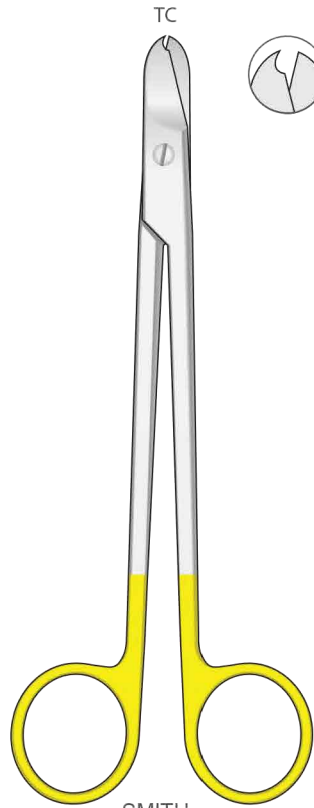




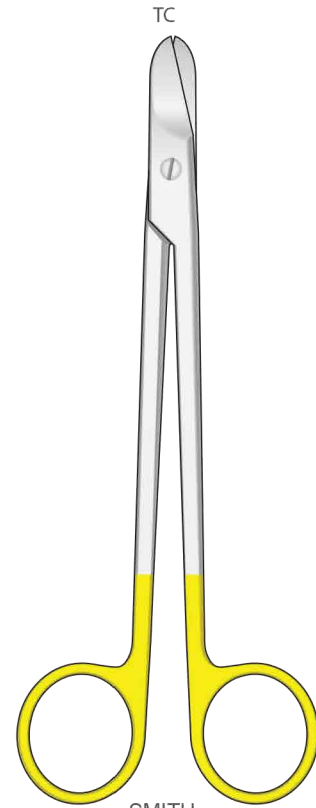
Drahtschneidezangen  
Wire cutting pliers  
Tronchesi per fili metallici  
Alicates para cortar alambre  
Pinces à couper les fils



TM-PH-58  
150 mm

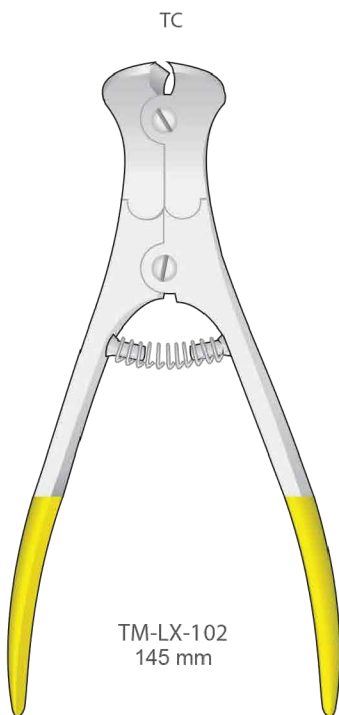


SMITH  
TM-FG-161  
160 mm

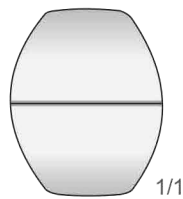


SMITH  
TM-FG-160  
160 mm

**Tungsten-Carbide Inserts**  
Mit Hartmetalleinsätzen  
Plaquettes en carbure de tungstène  
Plaquetas de carburo de tungsteno  
Inserti in carburo di tungsteno



TM-LX-102  
145 mm

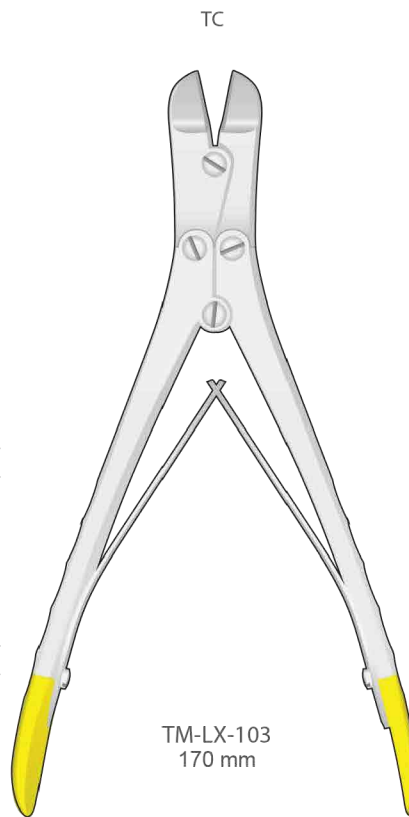


○ Max Ø 2.0 mm (.078")

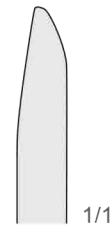
Für weichen Draht  
For soft Wire  
Per filo leggero  
Para alambre blando  
Pour fil léger

○ Max Ø 1.5 mm (.059")

Für harten Draht  
For hard Wire  
Per filo duro  
Para alambre duro  
Pour fil dur



TM-LX-103  
170 mm



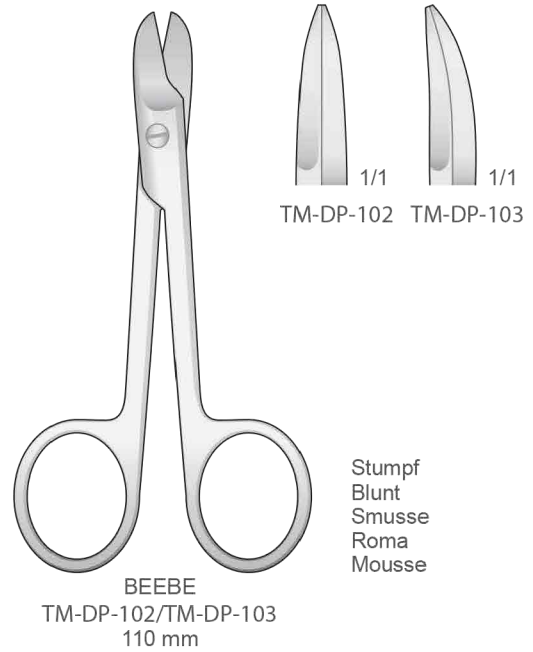
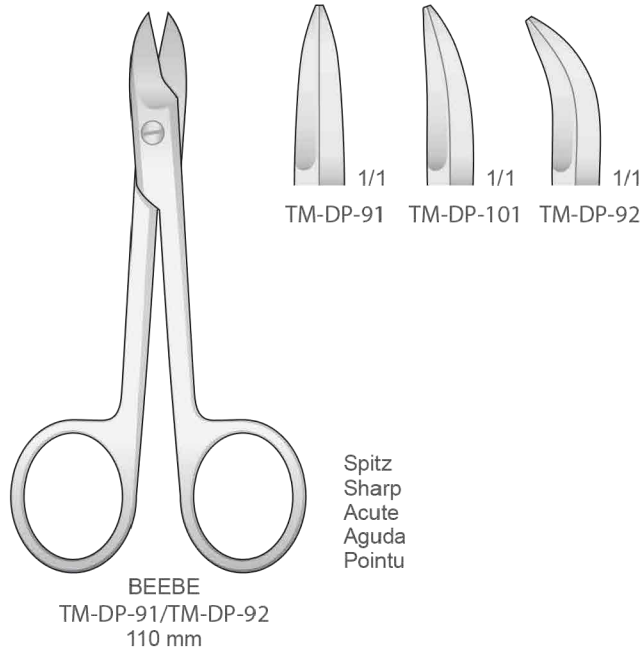
○ Max Ø 2.0 mm (.078")

Für weichen Draht  
For soft Wire  
Per filo leggero  
Para alambre blando  
Pour fil léger

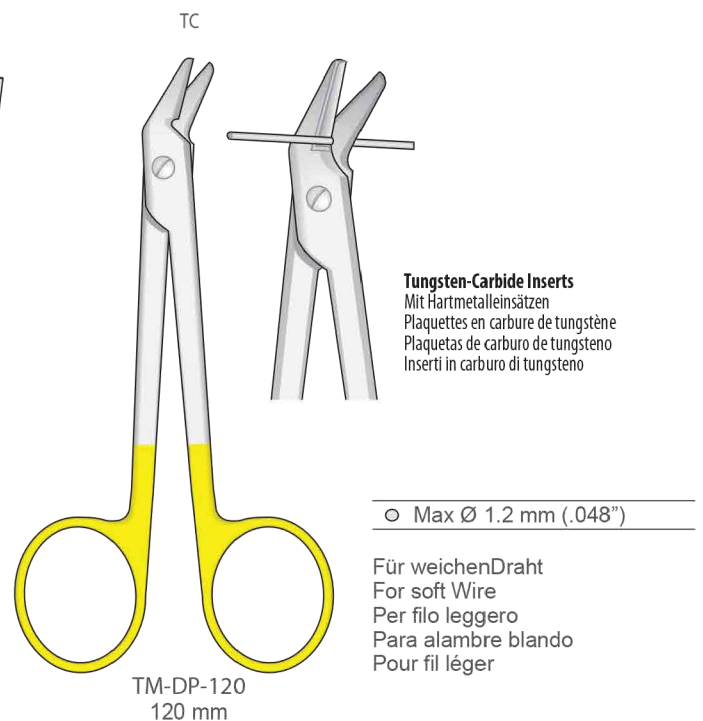
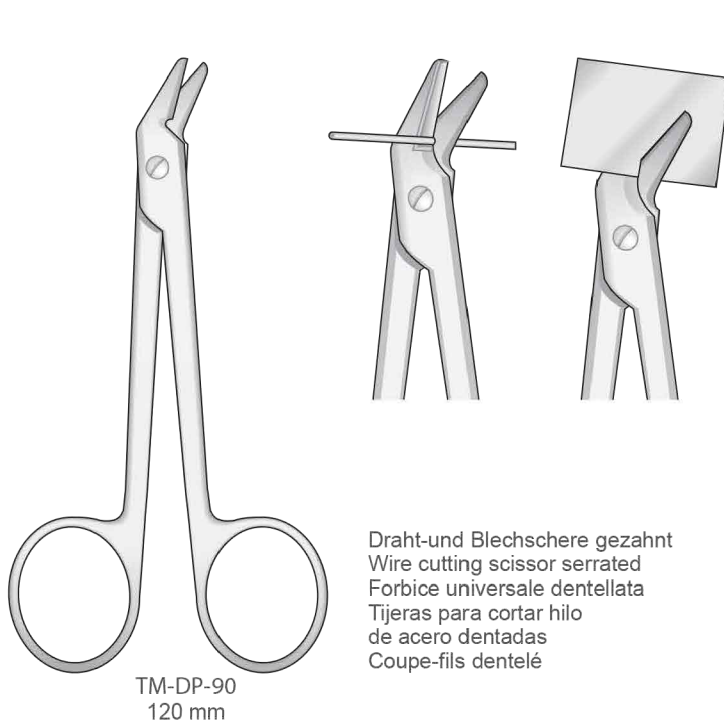
○ Max Ø 1.5 mm (.059")

Für harten Draht  
For hard Wire  
Per filo duro  
Para alambre duro  
Pour fil dur

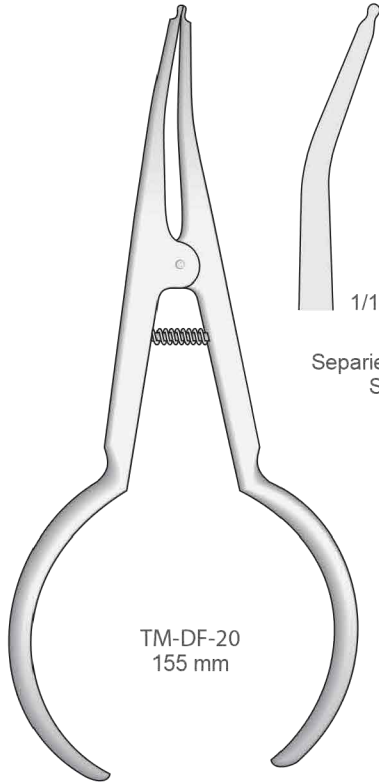
Scheren für dünne Stahl-und Edelmetallbleche - Scissors for thin steel and precious metal sheets  
Forbici per lamine sottili di acciaio e metalli preziosi - Tijeras para láminas delgadas de acero y metales preciosos  
Ciseaux pour couper les feuilles de métaux



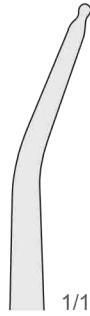
Scheren für dünne Stahl-und Edelmetallbleche - Scissors for thin steel and precious metal sheets  
Forbici per lamine sottili di acciaio e metalli preziosi - Tijeras para láminas delgadas de acero y metales preciosos  
Ciseaux pour couper les feuilles de métaux



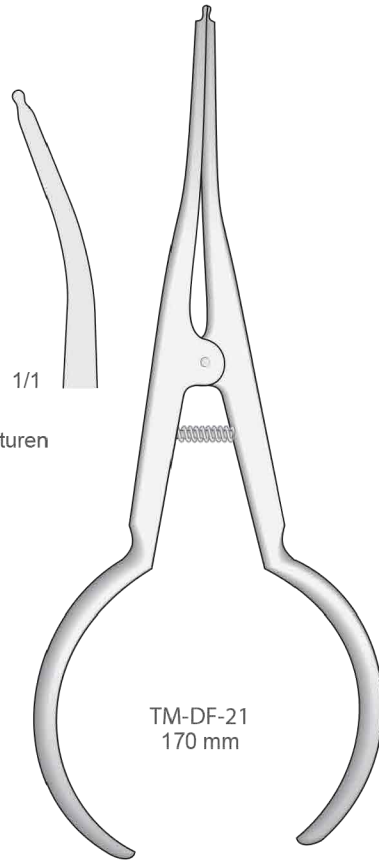
Separierzangen  
Separating Pliers  
Pinze tendielastici  
Pinza estira-elásticos  
Pince à separer



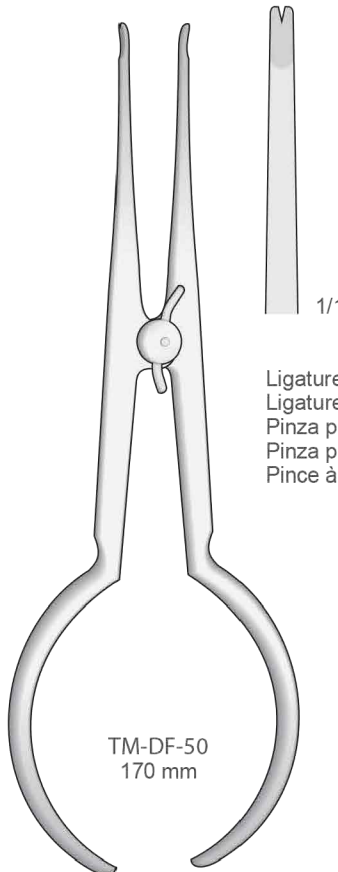
TM-DF-20  
155 mm



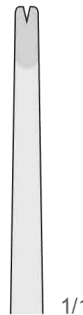
Separierzange, zum Einbringen von Gummi-Separierligaturen  
Separating forceps for inserting elastic separators  
Pinze per legature per separatori elastici  
Pinza para ligaduras estira-elásticos  
Pince à separer les ligatures



TM-DF-21  
170 mm



TM-DF-50  
170 mm



Ligaturenspannzange  
Ligature Tying Plier  
Pinza per legature  
Pinza para ligaduras  
Pince à serrer les ligatures



TM-DP-150  
160 mm

5.0  
4.0  
0

Bracketset Pinzette  
Bonding Bracket Forceps  
Pinzette per brackets  
Pinza fina para ligar brackets  
Fine pince à lier des boîtiers



**Aluminium**  
Aluminium  
Aluminium  
Aluminio  
Alluminio

TM-DP-100  
170 mm

Bracketpositioner  
Bracket Positioning Gauge  
Posizionatore per attacchi  
Posicionador de Brackets  
Positionateur des Brackets



Gezahnt  
Serrated  
Dentellato  
Dentado  
Dentelé

MERSHON  
TM-DP-50  
140 mm

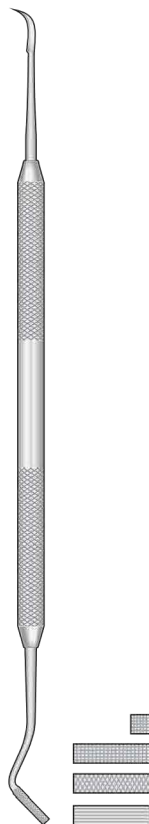
Verbandschieber  
Band Pusher  
Spingibande  
Empujador de bandas  
Enfonce-bague

Ligaturen Instrumente  
Ligating Instruments  
Strumenti per legature  
Instrumentos para ligaduras  
Instruments pour ligatures

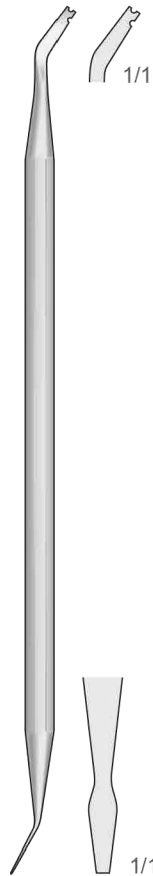
TM-DP-100  
170 mm



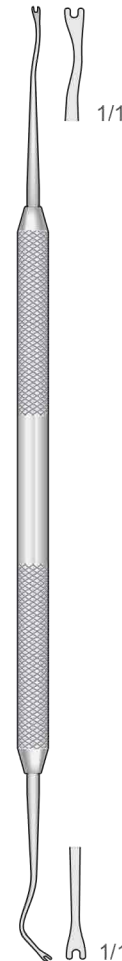
SHURE  
TM-DP-124  
175 mm



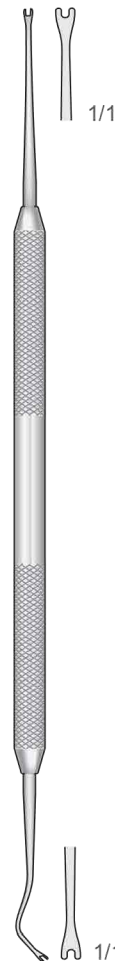
TM-DP-54  
175 mm



TM-DP-125  
155 mm



TM-PF-1  
170 mm

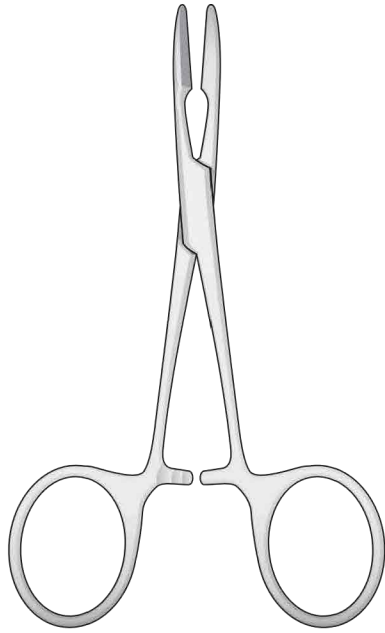


TM-PF-2  
170 mm

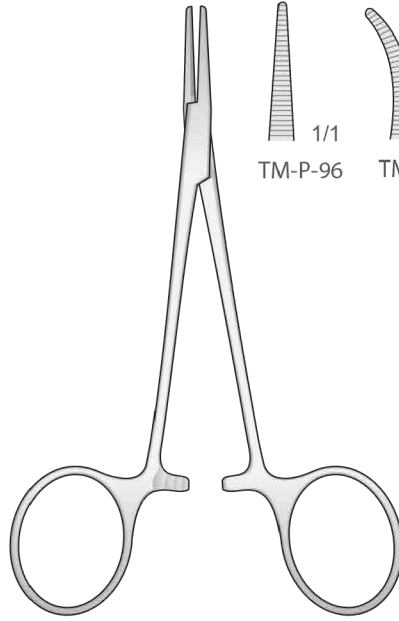


TM-PF-3  
160 mm

Ligaturen Instrumente  
Ligating Instruments  
Strumenti per legature  
Instrumentos para ligaduras  
Instruments pour ligatures



PEAN-MURPHY  
TM-BF-22  
130 mm



HALSTED-MOSQUITO  
TM-P-96/TM-P-97  
120 mm



TM-COLLEGE  
150 mm



MILLER  
DR-78  
145 mm

Bracketset Pinzette - Forceps for positioning brackets  
Pinzette per riposizionare gli attacchi diretti  
(posizionamento dei bracket)  
Pinza para colocar brackets - Précelle pour positionner les brackets

Bracket Gauge  
Stainless Steel



TM-DP-132  
130 mm



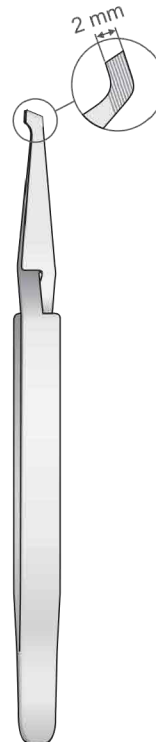
TM-DP-133  
130 mm



TM-DP-52  
130 mm



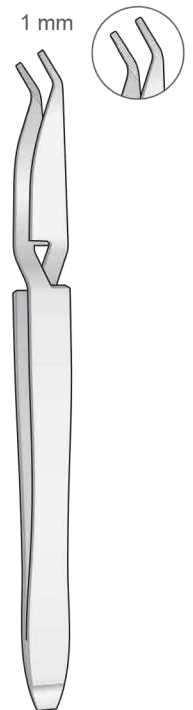
TM-DP-126  
110 mm



TM-DP-127  
125 mm

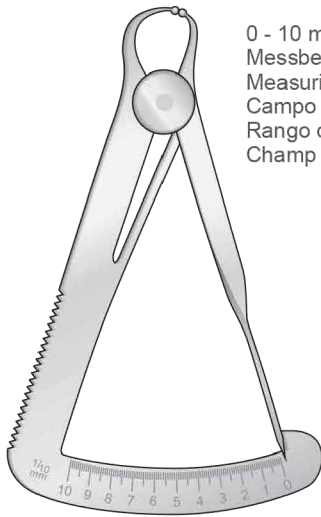


TM-DP-128  
145 mm



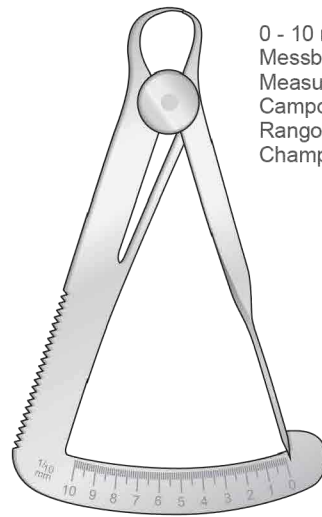
TM-DP-129  
130 mm

Dental-Schieblehre für Praxis und Labor  
Gauge Caliper for practice and laboratory  
Calibri dentali per studio e laboratorio  
Calibrador dental para práctica y el laboratorio  
Gauge calibreur pour pratique et laboratoire



0 - 10 mm  
Messbereich  
Measuring range  
Campo di misura  
Rango de medición  
Champ de mesure

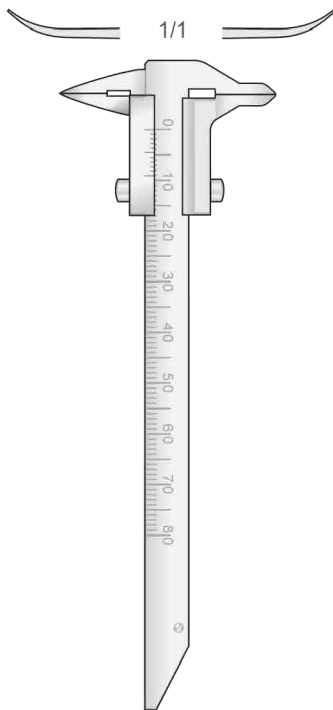
IWANSON  
TM-DP-721  
100 mm



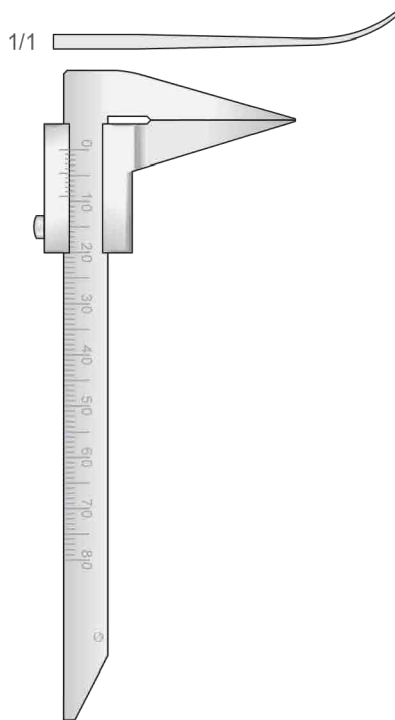
0 - 10 mm  
Messbereich  
Measuring range  
Campo di misura  
Rango de medición  
Champ de mesure

IWANSON  
TM-DP-720  
100 mm

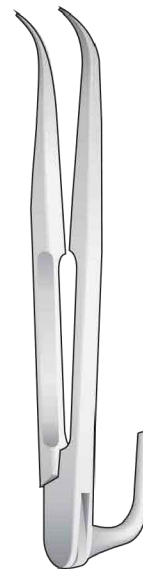
0 - 100 mm  
Messbereich  
Measuring range  
Campo di misura  
Rango de medición  
Champ de mesure



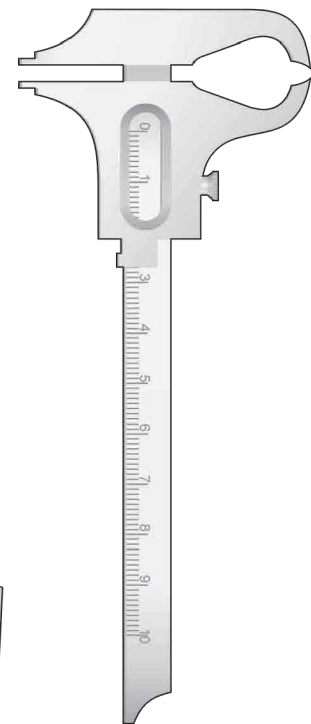
TM-DP-723  
80 mm



TM-DP-724  
80 mm

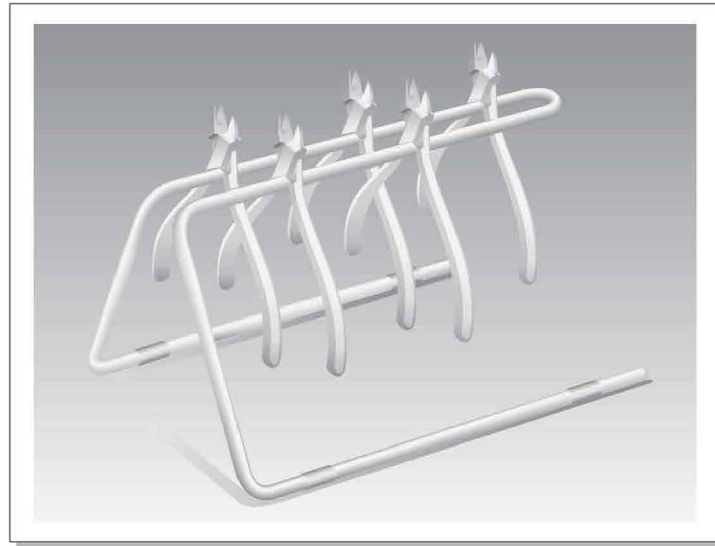


ZIELINSKY  
TM-DP-725  
110 mm



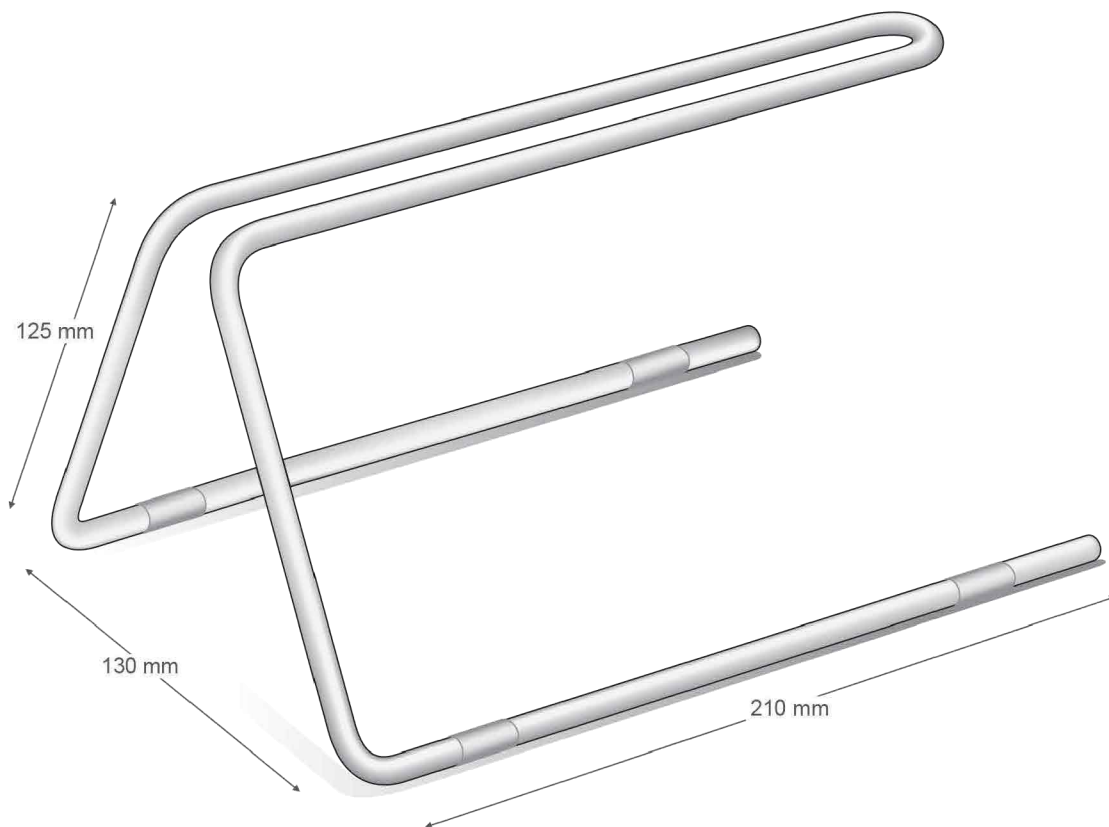
BOLEY  
TM-DP-730  
140 mm

Zubehör  
Accessories  
Accessori  
Accesorios  
Accessoires



Zangenständer  
Plier Stand  
Supporto per pinze  
Soportes para alicates  
Supports de pinces

**Stainless Steel**  
Rostfreier Stahl  
Acier inoxydable  
Acero inoxidable  
Acciaio inossidabile



TM-DP-140

## **Faisal Industries**

Bazzar Tibba Kakky Zaiyan  
Sialkot, PAKISTAN

Postal Code: 51310

 +92 344 600 8100

 [info@faisalindustries.co.uk](mailto:info@faisalindustries.co.uk)

 [www.faisalindustries.co.uk](http://www.faisalindustries.co.uk)

### **UK Office:**

24 Heacham close, luton, bedfordshire  
post cod LU4 0YJ United Kingdom  
PH: +44 7429 1938 60

*Faisal*

industries