



VETERINARY



SIALKOT - PAKISTAN



SI-1001
Right Side
with wooden handle
20 cm, 8"

SI-1002
Double Edged



SI-1003
With wooden handle
19 cm, 7½"
Right Side

SI-1004
19 cm, 7½"
Left Side



SI-1005
Left Hand

SI-1006
20 cm, 8"
Hoof knife, with especially
thin-ground blade, right hand



Hoof Knife
SI-1007
Stainless steel
handle



Paring Knife,
SI-1008
Oval curved,
for cutting claws
of cattle, with
wooden handle



Buss
SI-1009
Hoof knife,
ring shaped,
stainless steel
handle

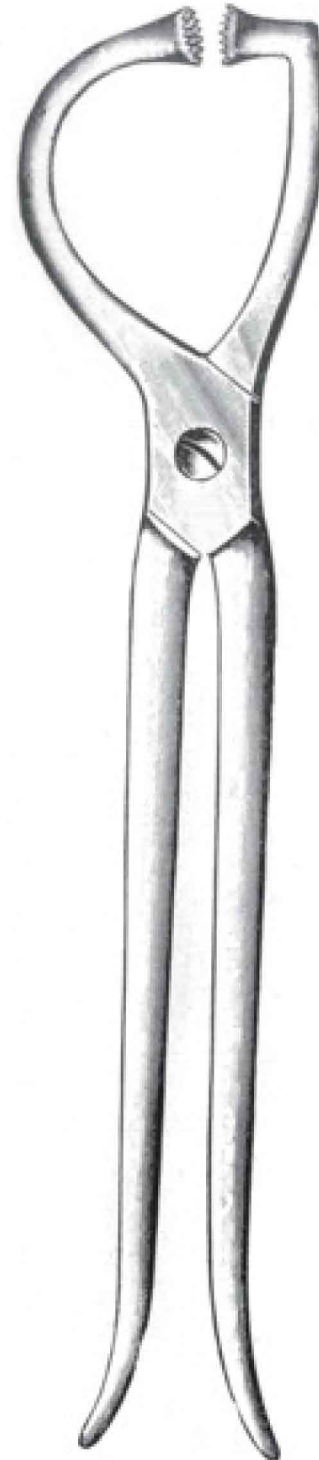

Vienna pattern
SI-1010
36 cm, 14 1/8"

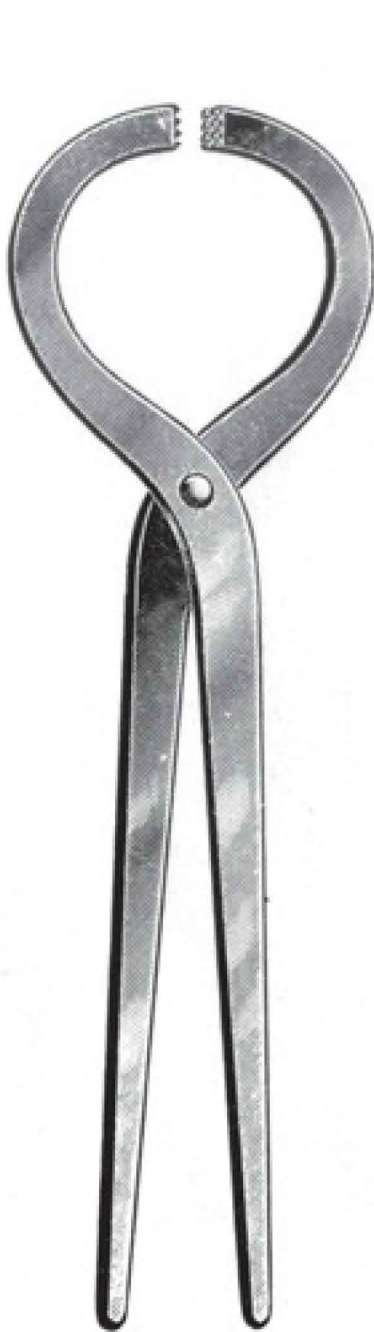

Hoof Testing Forceps
SI-1011
Forceps
30 cm, 11 3/4"
(our special item)



Hoof Tester
SI-1012
Large Drop Forged
Stainless Steel



Hoof Tester 13"
SI-1013
Drop Forged
Stainless Steel



Hoof Tester Round
SI-1014
Drop Forged
Stainless Steel



Hoof Tester Round
SI-1015
Flat 15" Forged
Stainless Steel
Round handle

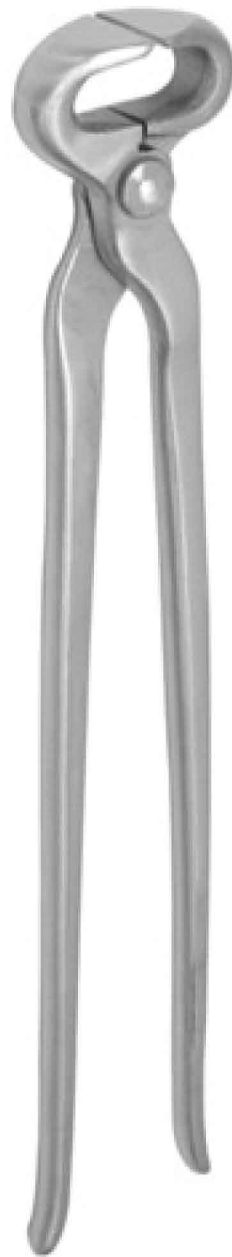

Hoof Nipper
SI-1016
Drop Forged
Stainless Steel



Hoof Nipper
SI-1017
Drop Forged
Stainless Steel



Hoof Cutters
SI-1018
30 cm, 11 $\frac{3}{4}$ "

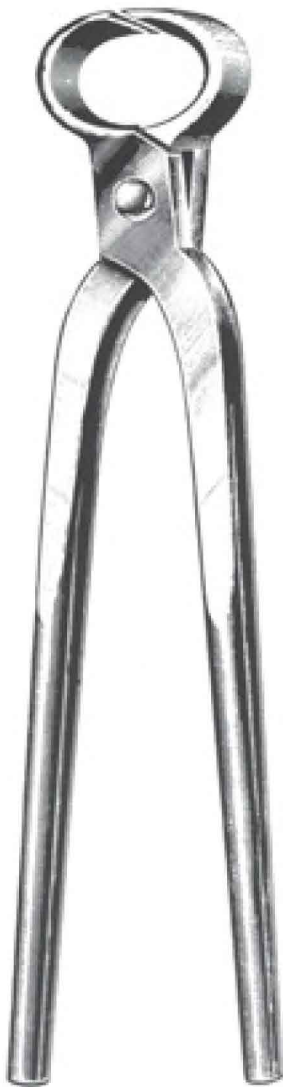

**Hoof and
Claw Cutter**
SI-1019
41 cm, 16"



Hoof Rasps
SI-1020
30 cm, 11¾"

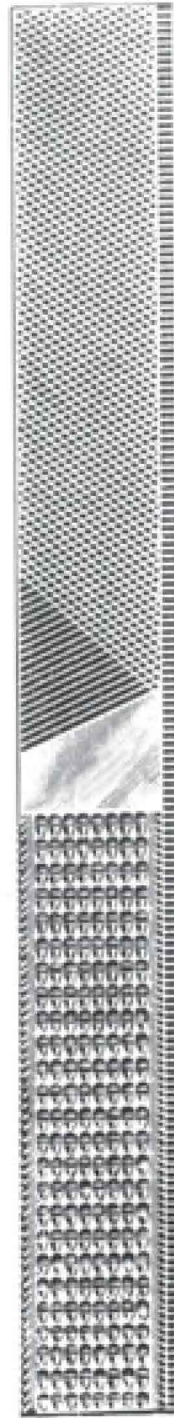

Hoof Rasps
SI-1021
35 cm, 13¾"



Berlin pattern
SI-1022
27 cm, 10½"
Bill shaped forceps
for use in resection
of the hoof certilage.

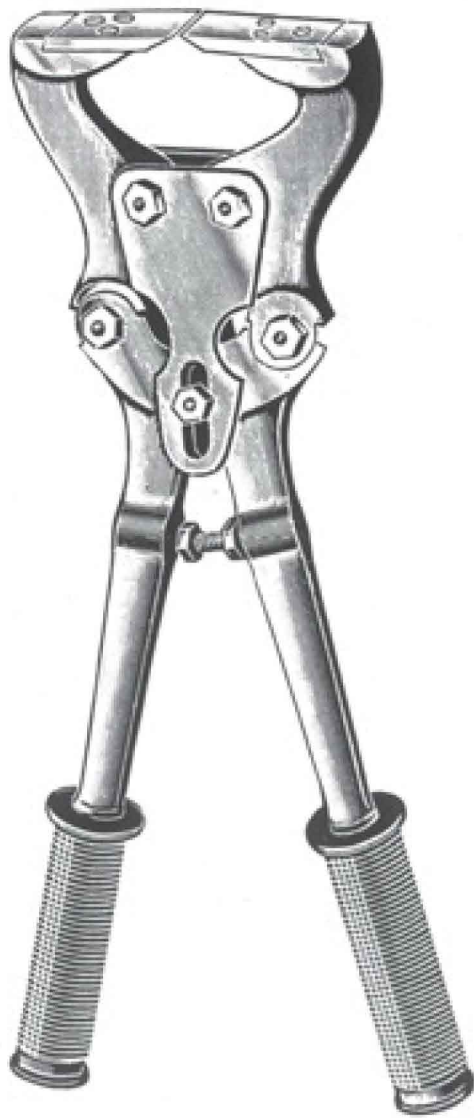

Hoof & Claw Cutter
SI-1023
41 cm, 16"
(our popular model)

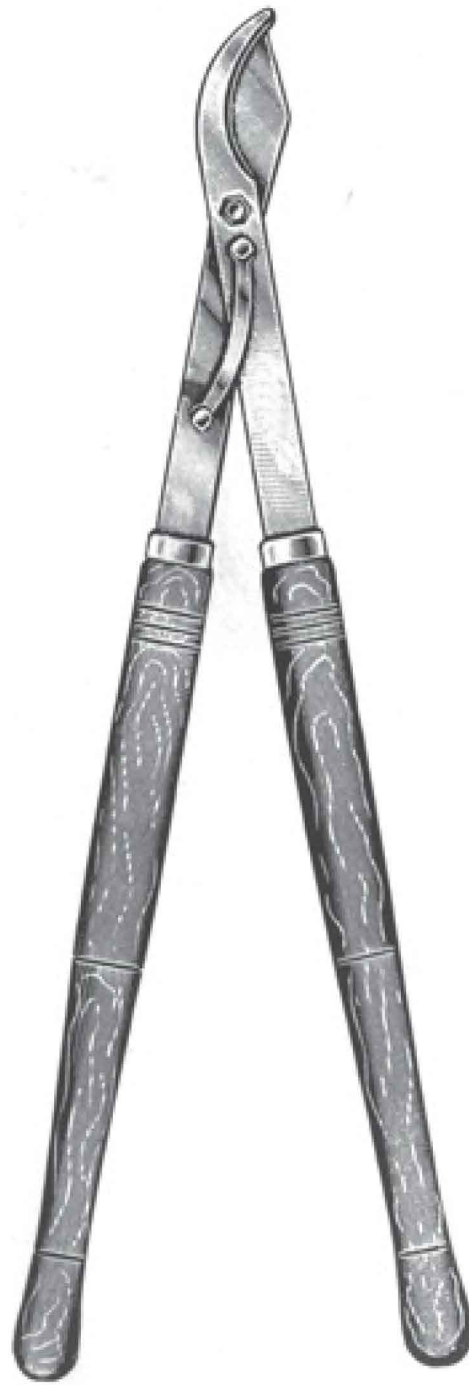

Claw Scissors for Cattles
SI-1024
70 cm, 25½"



Caw Cutter, side action
SI-1025
60 cm, 23½"



Barnes Dehorner
SI-1026

- A. Made from very hard steel to easily cut, attractively painted, and grip made of special plastic, very popular instrument. (American Pattern)
- B. Also available with wooden handle in very competitive price.

SI-1027
For calves age 3 - 6 months



Elastrator
SI-1028

Elastrator stretching forceps for dehorning cattle up to 2½ years of age (can also be used for castrating and docking lambs and pigs) by using the forceps place the horns and depending on the age of the animal the horns will fall off after a few weeks. (We sell in millions)



Krause
SI-1029
Milk sucking preventer



Roberts
SI-1030
For calves aged up to 3 months



Wide Toothed
SI-1031
Clipper with wooden handle



Narrow Toothed
SI-1032
Clipper with wooden handle

Animal Clippers



Wide Toothed
SI-1033
Cattle clipper without spring

Self-Retaining Retractors



SI-1034
15 cm, 6"

Gelpi-Loktite
SI-1035
15 cm, 6"

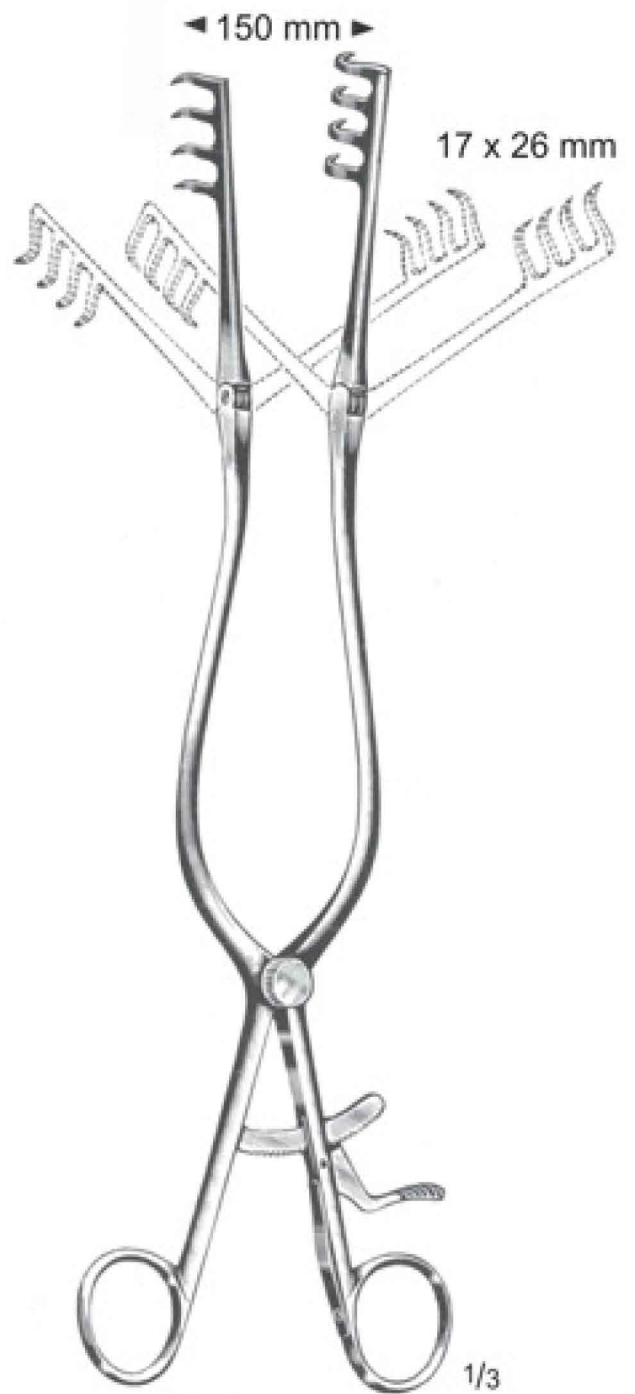
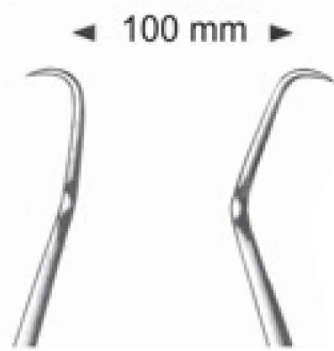

Beckmann
SI-1036
31 cm / 12 1/4"
Sharp / Blunt



Weitlaner
SI-1037
A. 13 cm, 5"
B. 16 1/2 cm, 6 1/2"
Sharp / Blunt

Self-Retaining Retractors



Finsen
SI-1038
7 cm, 2¾"

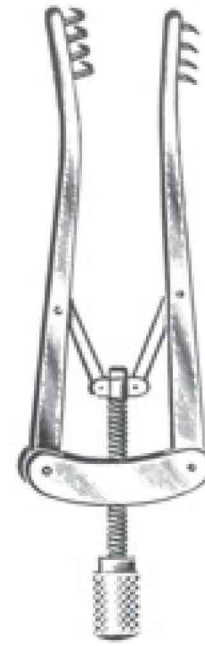

Alm
SI-1039
A. 7 cm, 2¾"
B. 10 cm, 4"



Weitlaner
SI-1040
10½ cm, 4 1/8"
Sharp



Weitlaner
SI-1041
A. 13 cm, 5"
B. 16 cm, 6½"
Sharp / Blunt

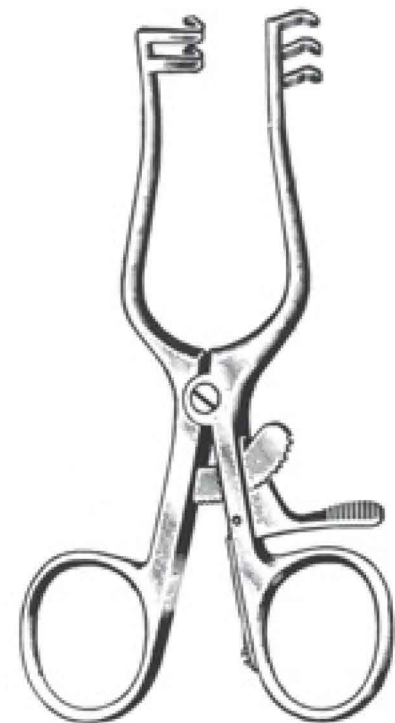

Weitlaner
SI-1042
10½ cm, 4 1/8"
Blunt

Self-Retaining Retractors

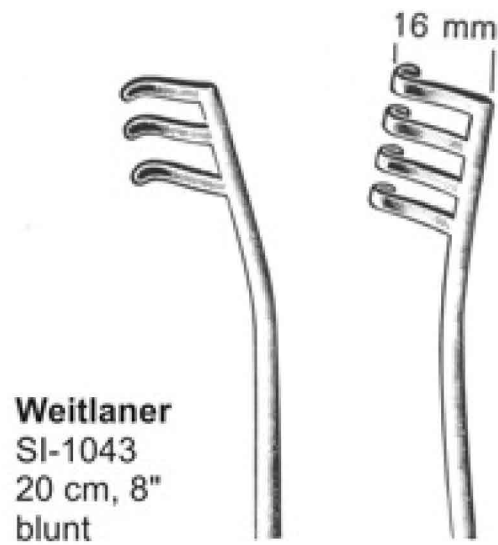

Weitlaner
SI-1043
20 cm, 8"
blunt

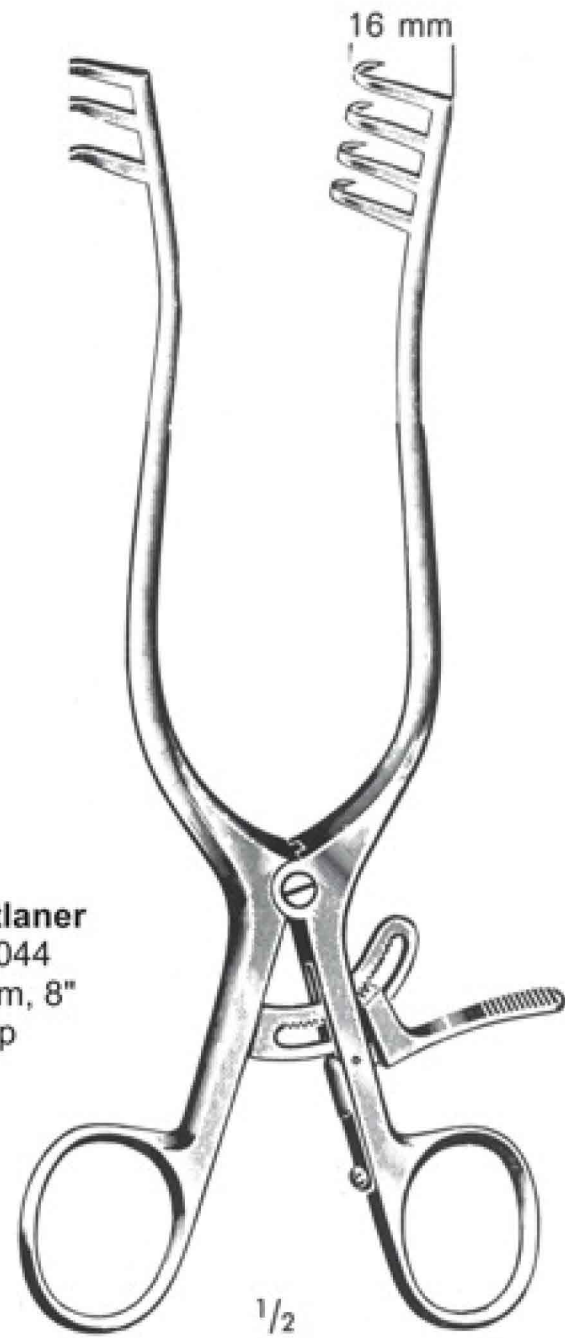

Weitlaner
SI-1044
20 cm, 8"
sharp

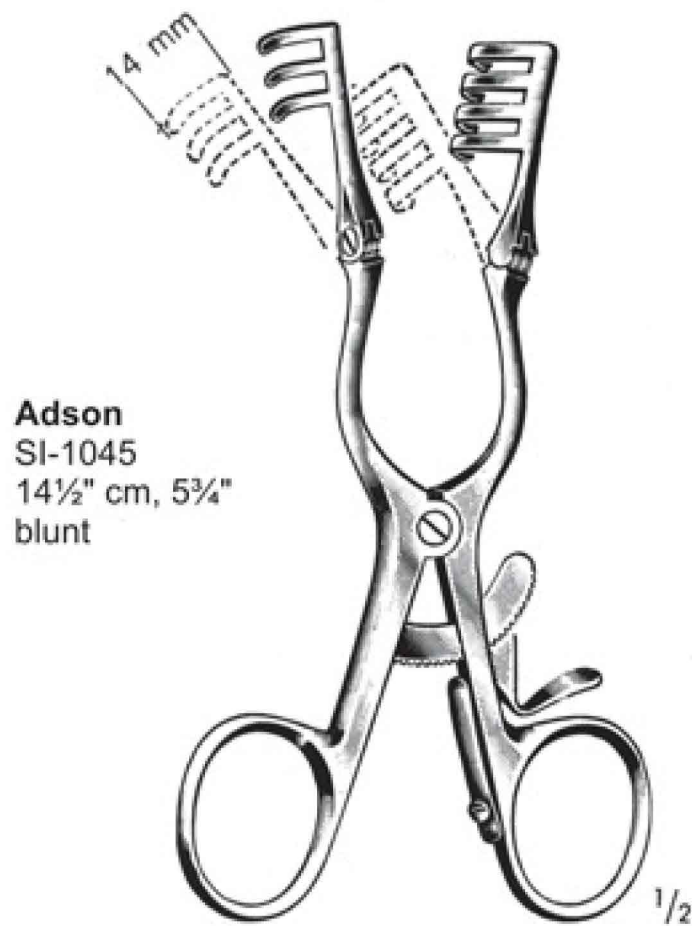

Adson
SI-1045
14½" cm, 5¾"
blunt

Self-Retaining Retractors

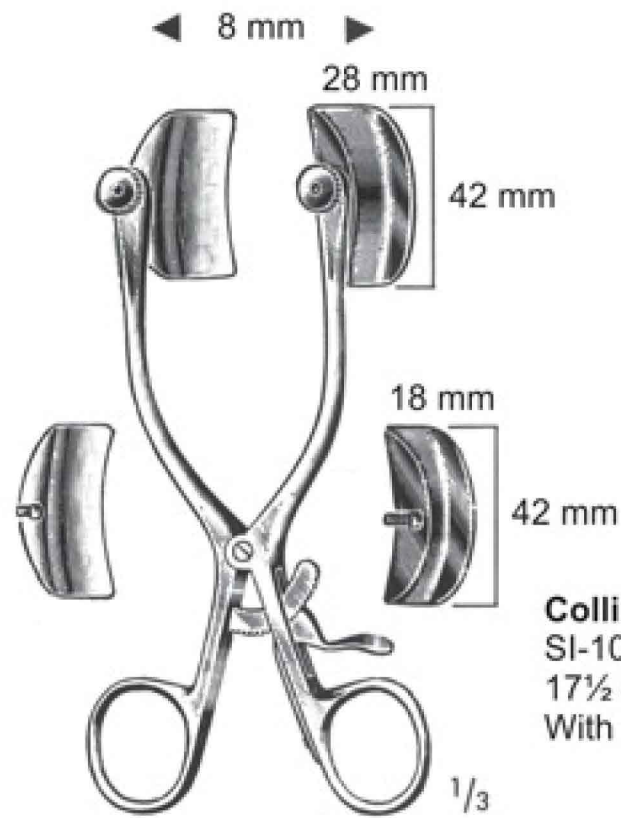

Collin
SI-1046
17½ cm, 7"
With 2 Pair of blades

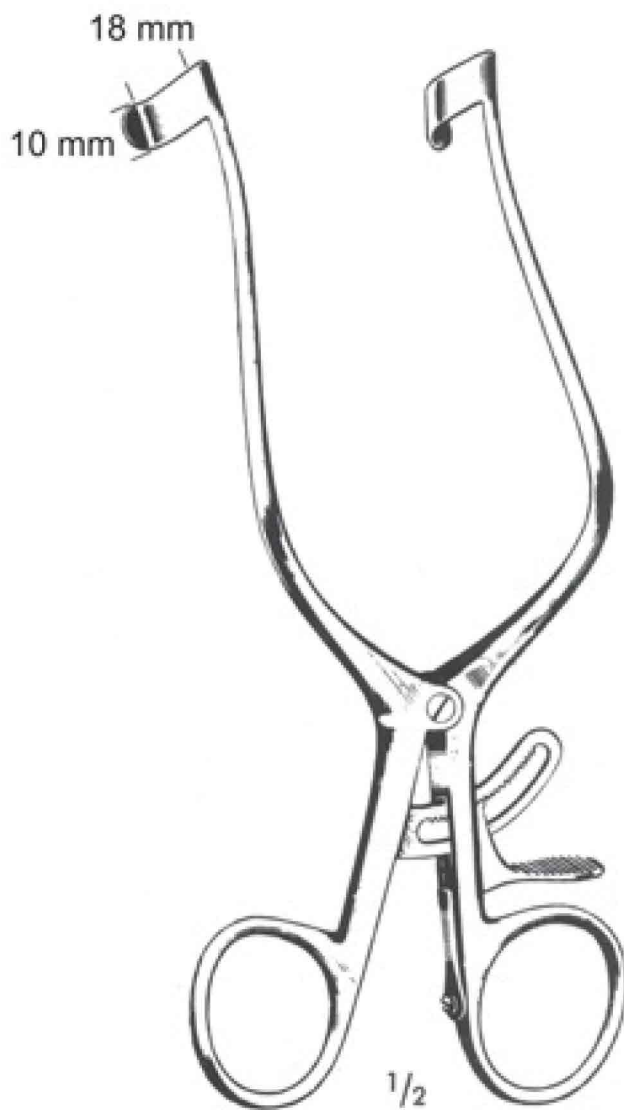

Tubingen Pattern
SI-1047
16 cm, 6¼"

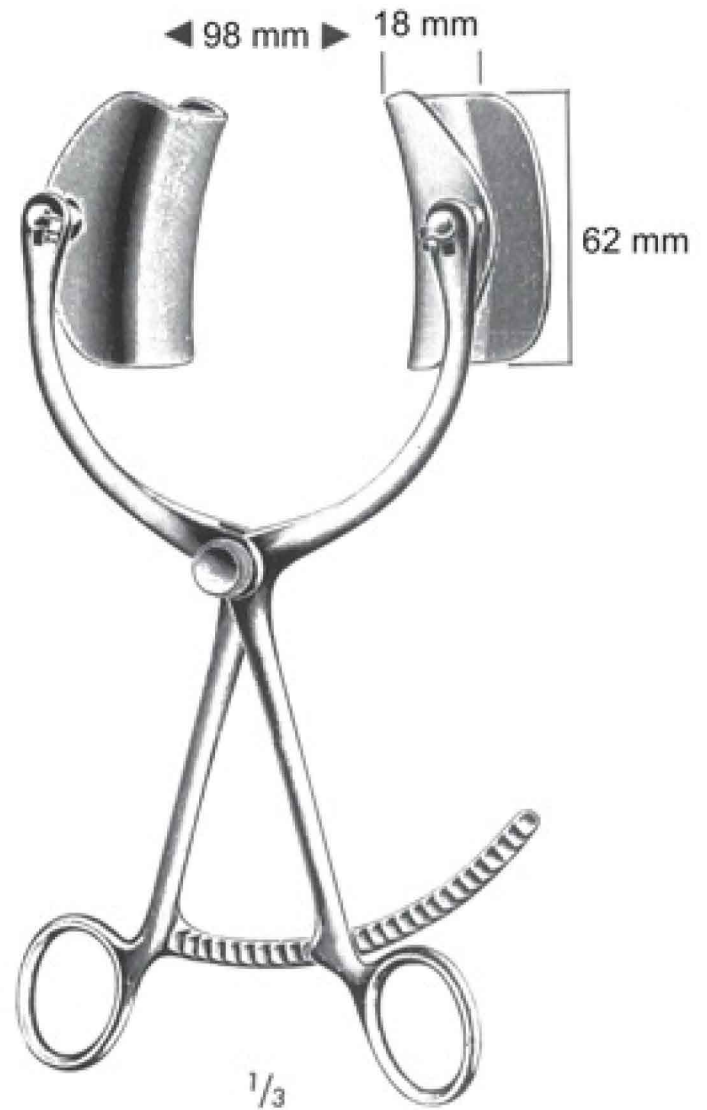

Collin
SI-1048
22 cm, 8¾"

Instruments for Castration Emasculators



**Castration Hook
for cats**
SI-1049
17 cm, 6³/₄"



Hausmann
SI-1050
A. 19 cm, 7¹/₂"
B. 23 cm, 12¹/₄"
straight



Hausmann
SI-1051
A. 27 cm, 10-5/8"
B. 31 cm, 12¹/₄"
straight



Hausmann
SI-1052
A. 19 cm, 7¹/₂"
B. 27 cm, 10-5/8"
curved

Castration Forceps Emasculators

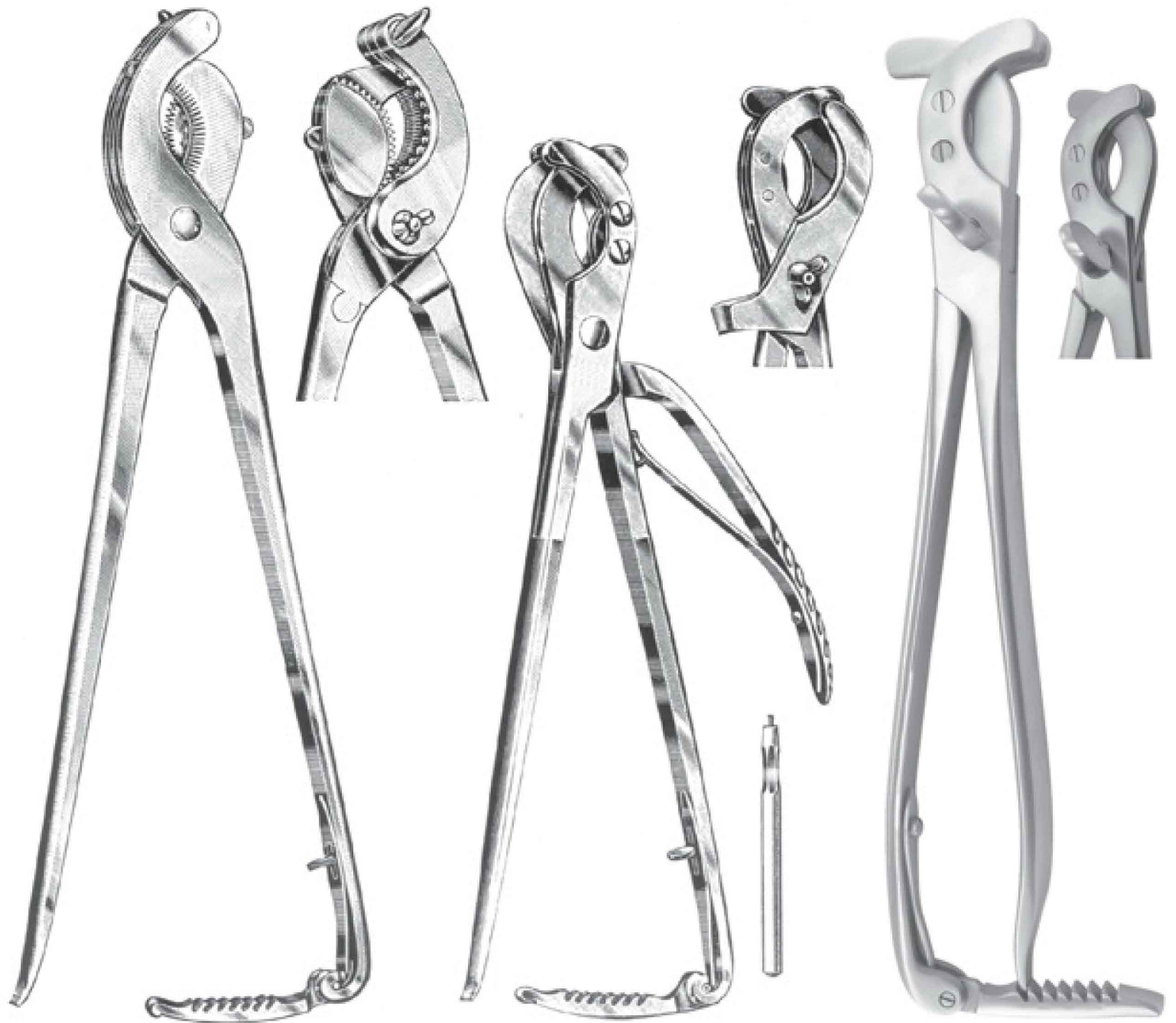

Bertschy
SI-1053
37½" cm, 14¾"

Reimers
SI-1054
33 cm, 13"
With cutting device
avec 3 branches

Sand Castrating Forceps
SI-1055
German pattern,
very popular model
throughout the world
35 cm, 14"

Instruments for Castration Emasculators

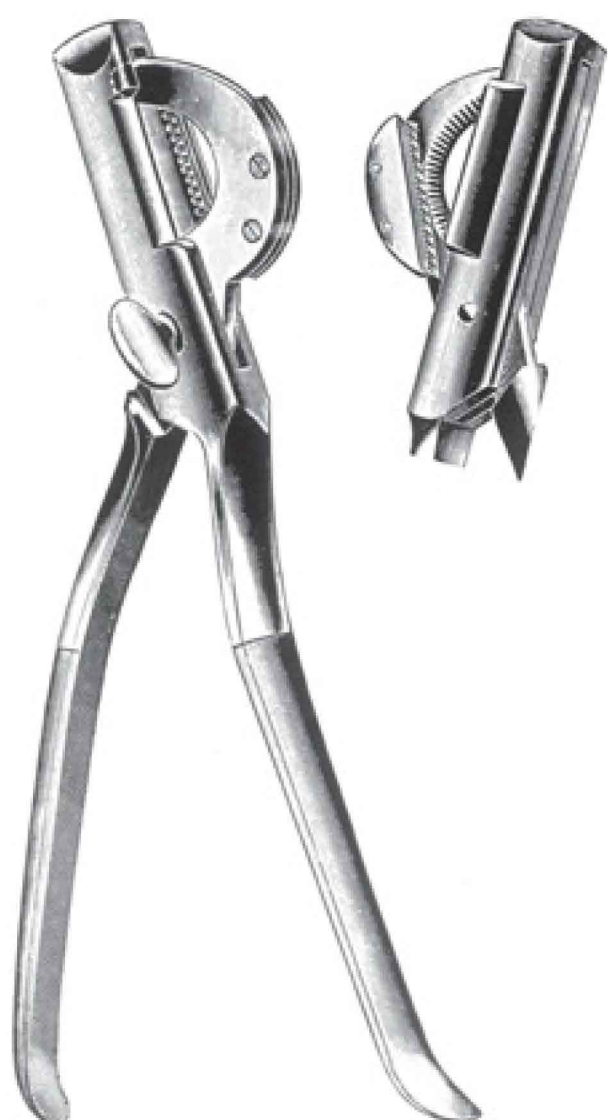

Verboczy
SI-1056
27 cm, 10½"
With clamping parts



Newberry Castrating Knife
SI-1057
USA model, stainless steel



Mc Indoe
SI-1058
Bone Cutting Forceps
curve on flat
17½" cm, 7"

Castration Forceps

***Castration Forceps with Cord-Stop
Double Action, Modified Pattern, without Knee-Piece***



SI-1059
23 cm, 9"



SI-1060
30 cm, 11 3/4"
With Wooden Handle



SI-1062

SI-1063 34 cm, 13 3/8"
SI-1064 40 cm, 15 3/4"
SI-1065 45 cm, 17 3/4"
Wooden Handle

SI-1061

Trocars



\varnothing 4 cm \varnothing 5 cm \varnothing 6 cm \varnothing 5 cm \varnothing 8 cm \varnothing 10 cm
 SI-158 A SI-158 B SI-158 C

SI-1066
 16 cm, 6 $\frac{1}{4}$ "
 A. With Stainless Steel Handle

SI-1067
 16 cm, 6 $\frac{1}{4}$ "
 A. With Wooden Handle
 B. With Stainless Steel Handle

SI-1068
 19 cm, 7 $\frac{1}{2}$ "
 A. With Wooden Handle
 B. With Stainless Steel Handle

SI-1069
 22 cm, 8 $\frac{3}{4}$ "
 A. With Wooden Handle
 B. With Stainless Steel Handle

Spare Tube

Trocars

 $\frac{1}{1}$
 ϕ 12 x 6 mm

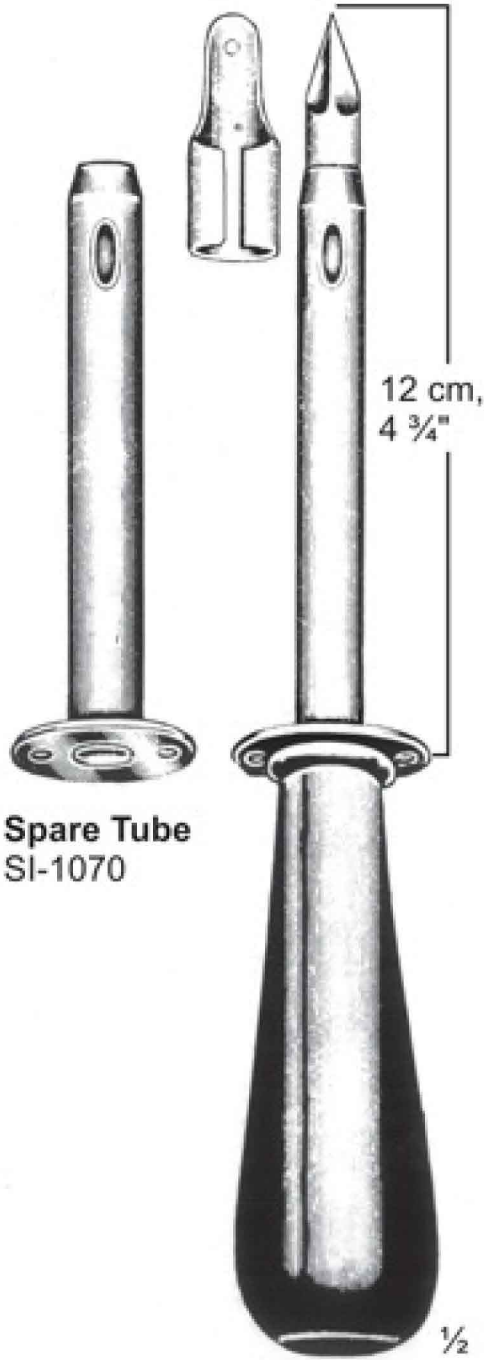

Spare Tube
SI-1070

SI-1072
20 cm, 8"
A. Stainless Steel Handle
B. With Wooden Handle

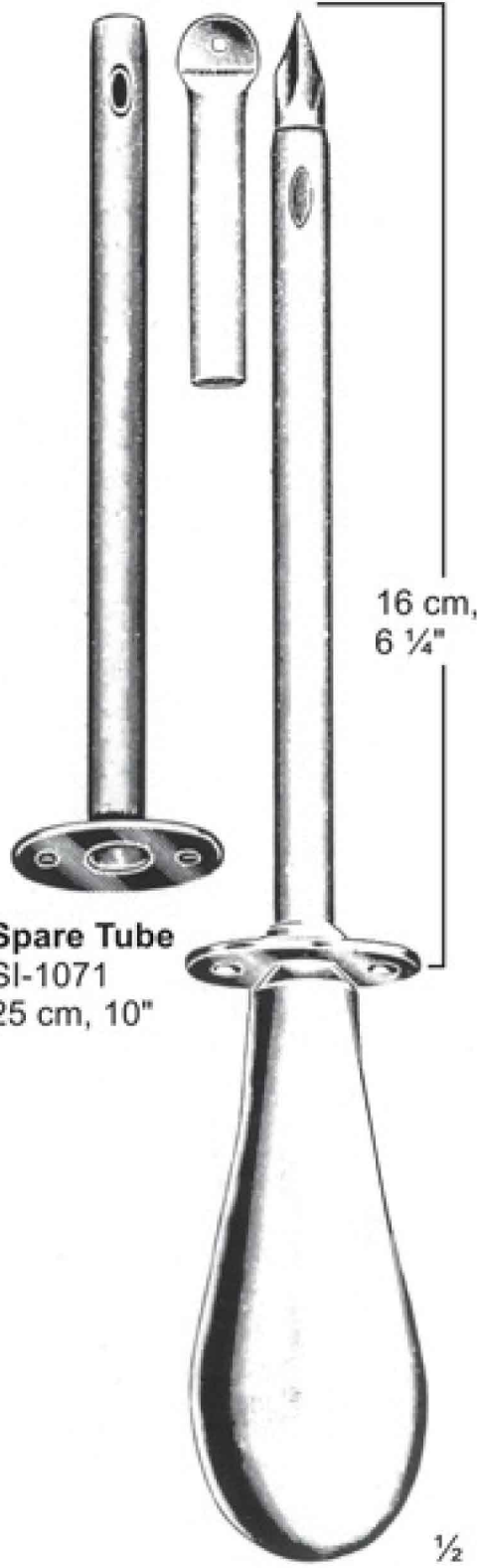

Spare Tube
SI-1071
25 cm, 10"

Dolz-knauer
SI-1073
25 cm, 10"
A. Stainless Steel Handle
B. with Wooden Handle

 $\frac{1}{1}$
 ϕ 9 x 7 mm



Stomach tube
SI-1074
Soft Rubber for introducing
liquid medicines through
the nose, for young cattle
(foals etc.)
19/32 diam 98½" long

SI-1075
For Large Cattles
5/8 diam 118" long



BEIN
SI-1076
Root Elevator
Stainless Steel Handle



FLOHR
SI-1077
Root Elevator, Right
Stainless Steel Handle



FLOHR
SI-1078
Root Elevator, Left
Stainless Steel
Handle



SI-1079
Tooth Forceps for Whelps
and other small animals,
slightly bent
Stainless Steel Handle

Tooth Instruments



SI-1080
Scalar, Hook Shape



SI-1082 SI-1083
Scalar, Wing Shape



SI-1084 SI-1085
Scalar, Hatchet Shape



PROBES

SI-1086
Ø22 mm
Mouth Mirror,
Plain



SI-1081
Enamel Chisel
and scalar

PROBES



SI-1087
Knopf-Ø
Ø of tips

Lenght

	1,5 mm	2 mm		
SI-1088	SI-1095	12	cm, 5"	
SI-1089	SI-1096	14½	cm, 5¾"	
SI-1090	SI-1097	16	cm, 6¼"	
SI-1091	SI-1098	18	cm, 7"	
SI-1092	SI-1099	20	cm, 8"	
SI-1093	SI-1100	25	cm, 10"	
SI-1094	SI-1101	30	cm, 11¼"	



SI-1102
A. 25 cm, 10"
B. 30 cm, 11¼"
Tin, malleable



SI-1103
Handle for
mouth mirror

Needle Holders with Carbide Tips & Handle Gold Plated



Mayo-Hegar (Plain)

SI-1104 15 cm, 6"
 SI-1105 18 cm, 7"
 SI-1106 20 cm, 8"
 Stainless Steel

Medium fine patterns

T/C Gold

SI-1107 6"
 SI-1108 7"
 SI-1109 8"

Mayo-Hegar

SI-1110 17 cm, 6¾"
 SI-1111 20 cm, 8"
 SI-1112 24 cm, 9½"
 Stainless Steel

T/C Gold

6" ¾
 8"
 9 ½"

Heavy patterns

Ermold

SI-1113 17 cm, 6¾"
 SI-1114 20 cm, 8"
 Stainless Steel

Needle Holders with Carbide Tips & Handle Gold Plated

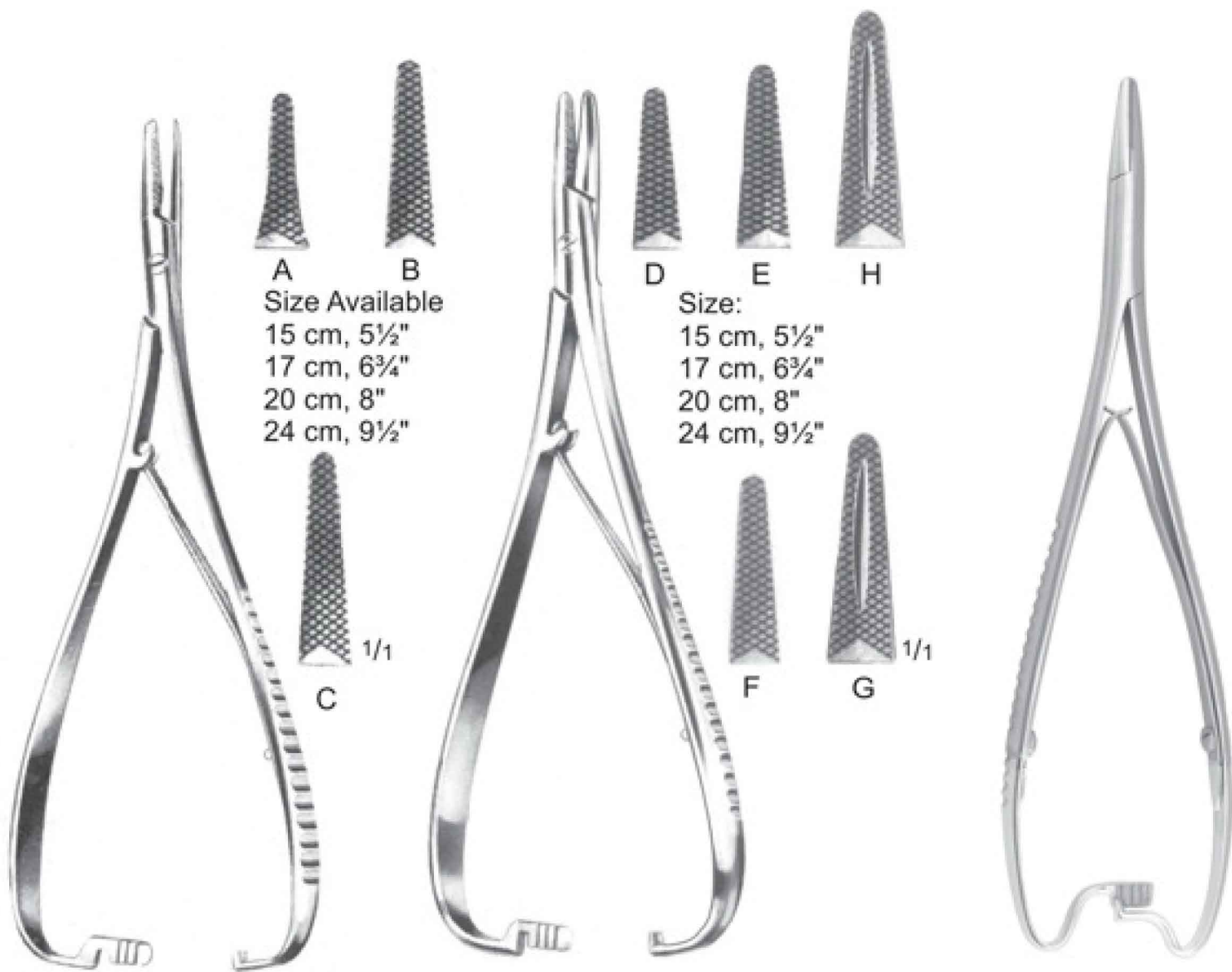

A B
 Size Available
 15 cm, 5½"
 17 cm, 6¾"
 20 cm, 8"
 24 cm, 9½"

D E H
 Size:
 15 cm, 5½"
 17 cm, 6¾"
 20 cm, 8"
 24 cm, 9½"

C 1/1

F G 1/1

Mathieu Needle Holder
 SI-1115
 Delicated pattern.
 with imported German
 carbide tips inserted
 golden handle, our
 special product.
 guaranteed
 stainless steel

Mathieu Needle Holder
 SI-1116
 Standard pattern
 with imported german
 carbid tips inserted
 golden handle.
 our speciality, guaranteed
 stainless steel

Mathieu
 SI-1117 18 cm, 7"
 SI-1118 20 cm, 8"
 SI-1119 24 cm, 9½"

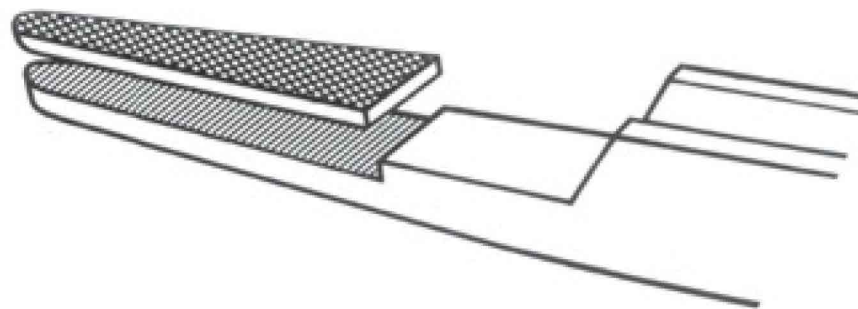

5 Years Guarantee

Mathieu (with out T/C)
 SI-1120 14 cm, 5½"
 SI-1121 17 cm, 6¾"
 SI-1122 20 cm, 8"
 SI-1123 24 cm, 9½"

Mathieu (with T/C)
 SI-1124 14 cm, 5½"
 SI-1125 17 cm, 6¾"
 SI-1126 20 cm, 8"
 SI-1127 24 cm, 9½"

Note: Needle holder with two arms are also available on demand.

(Foreign Body Instruments)

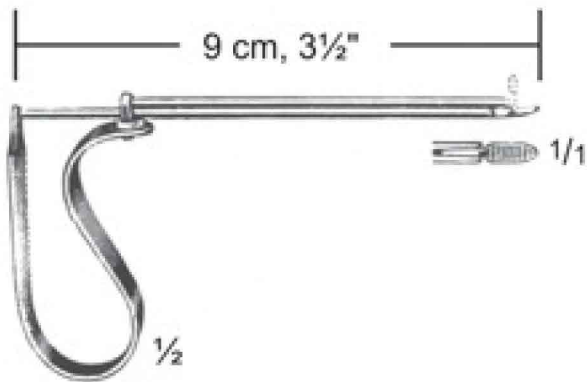

Quire
SI-1128
Lever for foreign bodies



Hartmann
SI-1129
Delicate Pattern

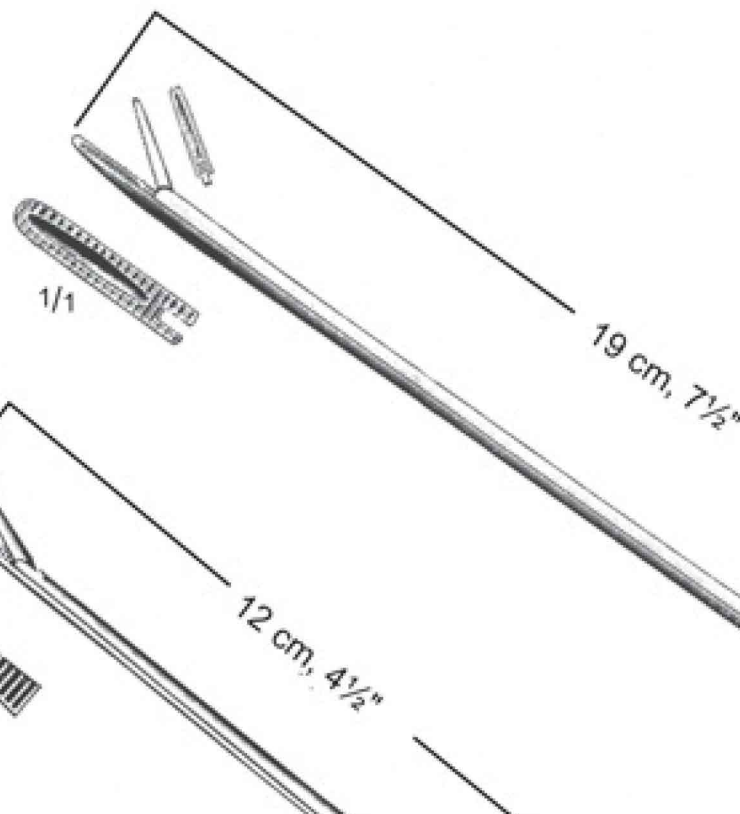

Hartmann
SI-1131
Heavy Pattern



Hartmann
SI-1130
Standard Pattern



Mathieu
SI-1132
Standard Pattern

Colporrhaphy & vulva sutures



Gerlach
SI-1133
18 cm, 7"

Reverdin
SI-1134
19½ cm, 7¾"

SI-1135

SI-1136

SI-1137

SI-1138



Schulze
SI-1139
For horses and cattle

1/5



Gunther Hepke
SI-1140
4½" Distance 11 cm
our special quality
(very popular model)

1/6



Bayer
SI-1141
For horses and
cattle

1/3



Mouth Gags
SI-1142
10½ cm, 4 1/8"
15 cm, 6"
stainless steel

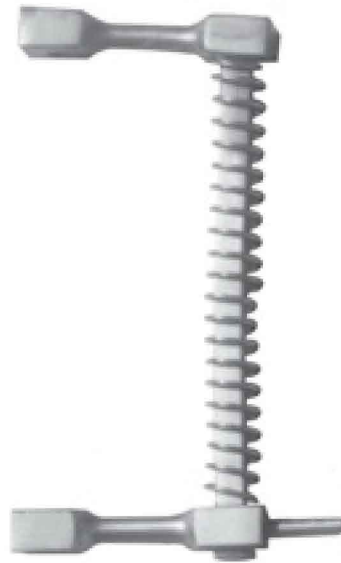

Mouth Gags
SI-1143
10½ cm, 4 1/8"
15 cm, 6",
stainless steel
latest new pattern

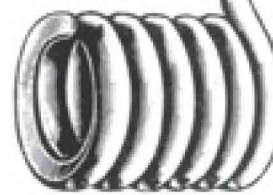

Schoupe
SI-1144
2¾" distance
Encartement
7 cm.
stainless steel

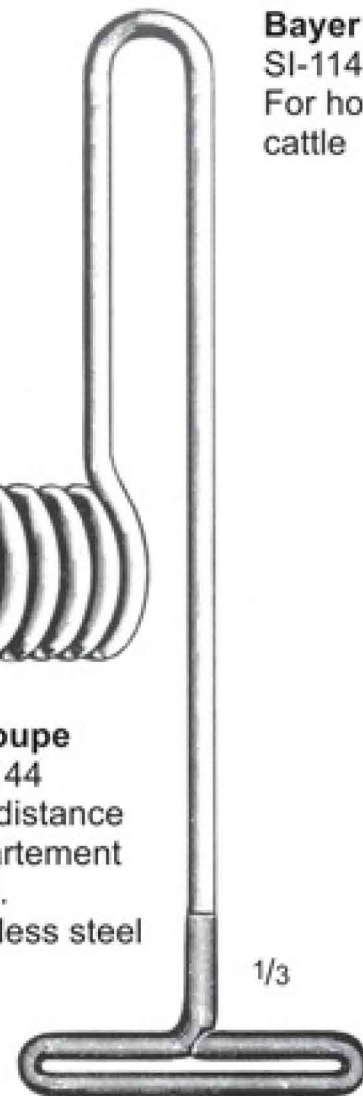

1/3

Nose Pincer (bull-temper)

**Bull Holders
Nose Pincer (Bull Tamer)**



SI-1145
11 cm, 4¼"



SI-1146
16½ cm, 6½"



SI-1147
18½ cm 7¼"

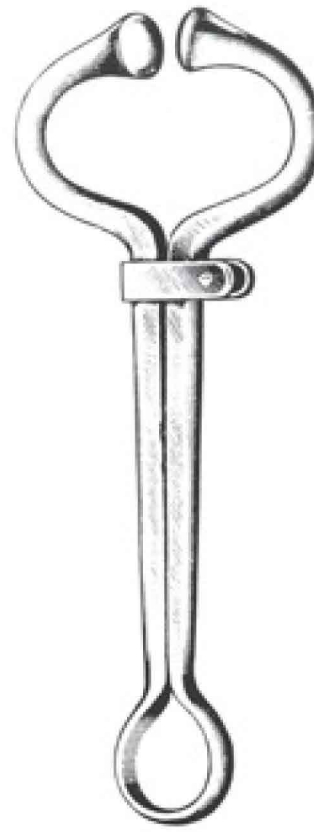

Harms
SI-1148
18½ cm 7¼"
Forged steel

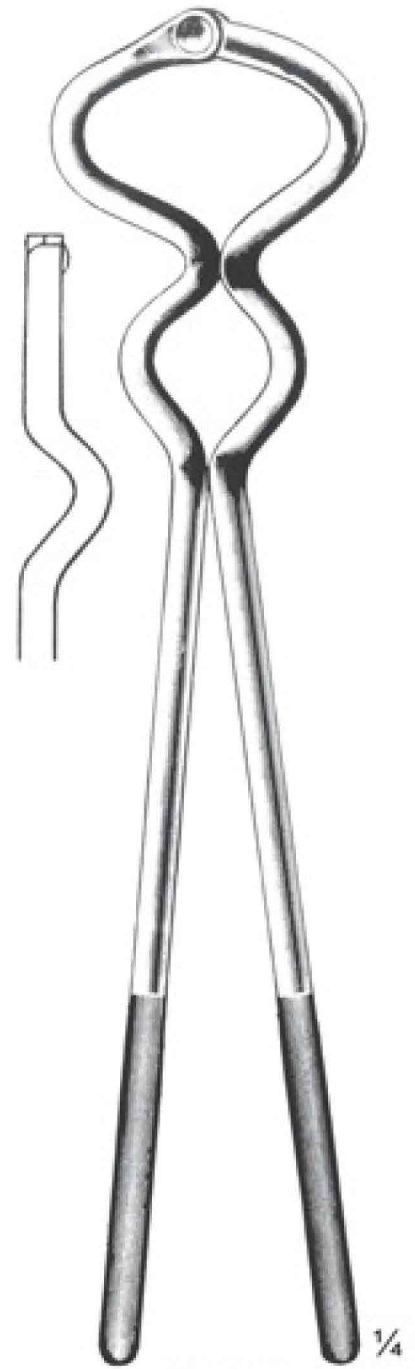

SI-1149
43½ cm, 17"

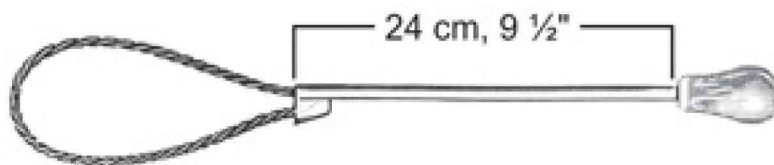

Nuesch
SI-1150
Pig paralysing instrument for holding pigs for inoculation



SI-1151
Wire nose pig holder for inoculation, rope approx, 58 cm long

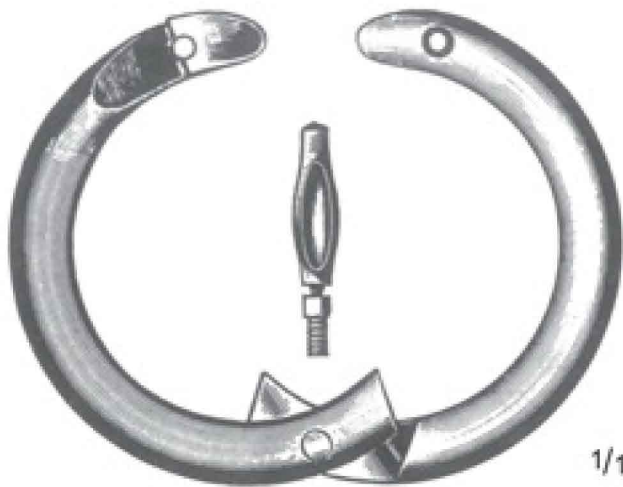

Nose Ring
SI-1152
Nickel-plated,
57 mm inside diameter

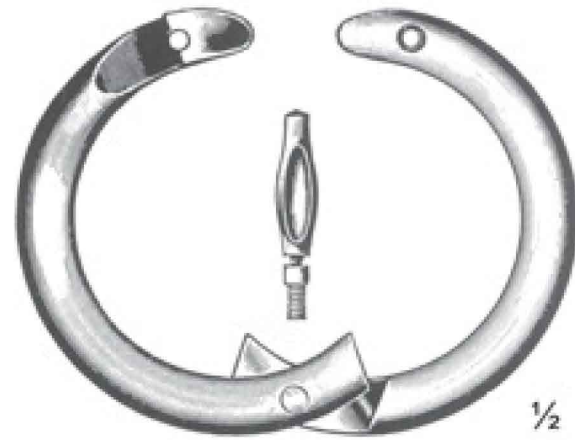

Nose Ring
SI-1154
Polished steel, nickel-plated,
2" inside diameter,
with safety screw



Strub
SI-1153



Frank
SI-1155
26½ cm, 10½"
Bull nose punch



Bull Nose Punch
SI-1156
For bull rings with
57 mm inside diam.
31 cm, 12¼"

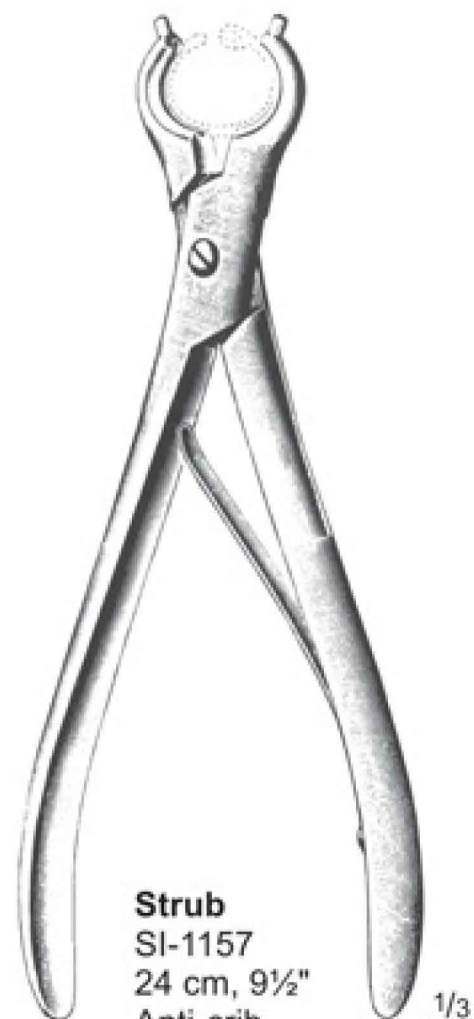

Strub
SI-1157
24 cm, 9½"
Anti-crib
biter and
applicator

Nose rings
SI-1158
For pigs,
29 mm inside
diameter

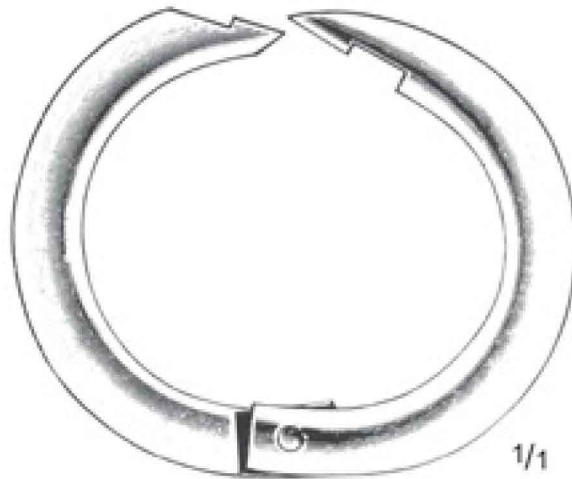

SI-1159



SI-1160

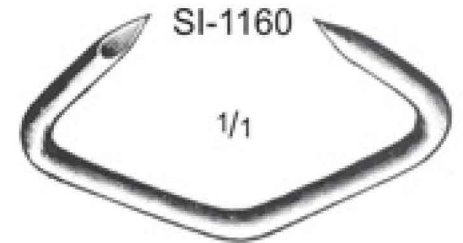

SI-1161



Applicators

Nose Rings
For pigs
packaged in a box



Applicator
SI-1162
26 cm, 10 1/4"
(Forged steel)
For nose rings
for pigs



Applicator
SI-1163
17 cm, 6 3/4"
Lacquered,
for nose rings
for pigs



Grasping Forceps
In stainless steel



SI-1164
Ø 1,2 mm,
14 cm, 5 1/2"



SI-1165
Ø 1,5 mm,
18 cm, 7"



SI-1166
Ø 1,8 mm,
18 cm, 7"



Hoffmann
SI-1167
19 cm, 7 1/2"
Shears for cutting
off heads of small
animals

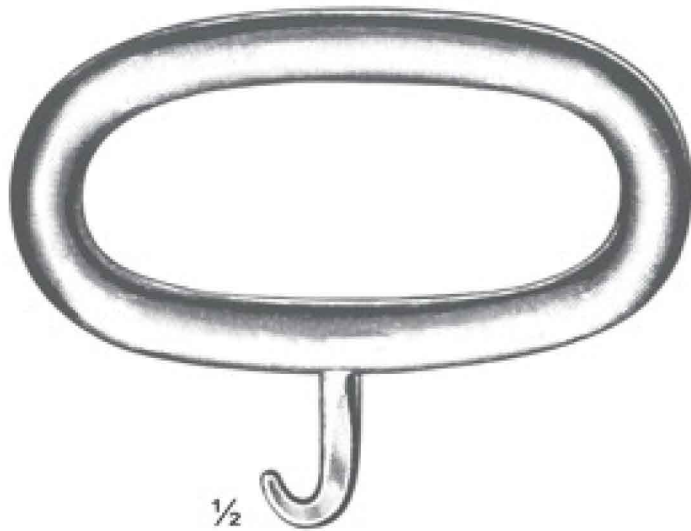

SI-1168
Obstetric chain handle

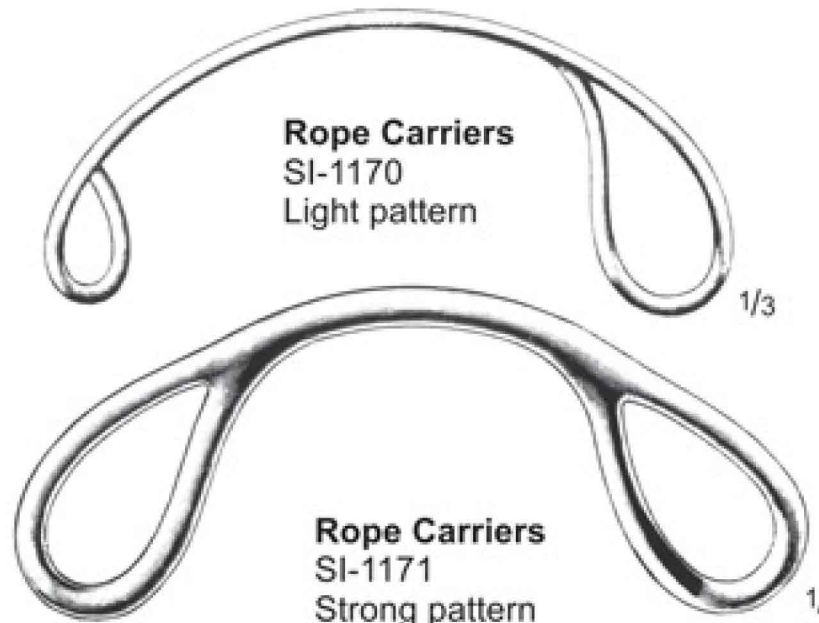

Rope Carriers
SI-1170
Light pattern

Rope Carriers
SI-1171
Strong pattern



SI-1169
European pattern
Sand Wire Carrier screw inside
stainless steel

Obstetric chains

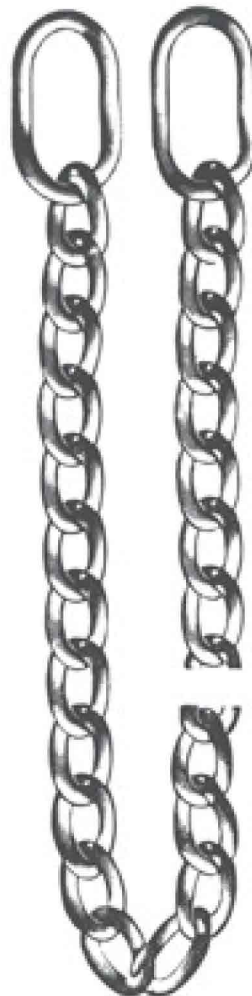

SI-1174
80 cm, 31½"
Nickle plated



SI-1175
190 cm, 75"
Nickle-plated

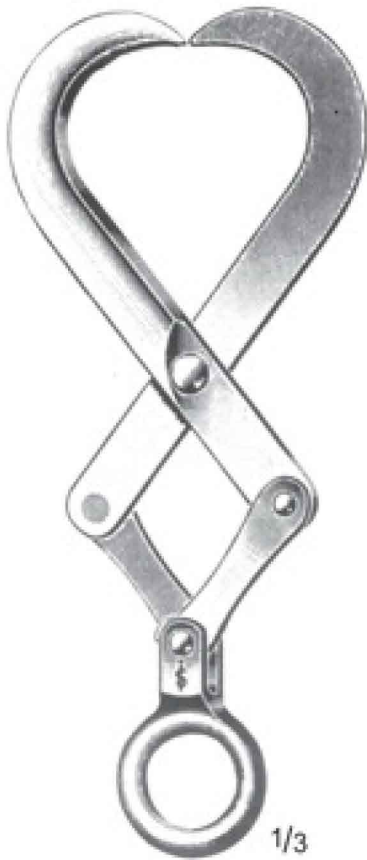

Krey-Schottler
SI-1172
21 cm, 8¼"

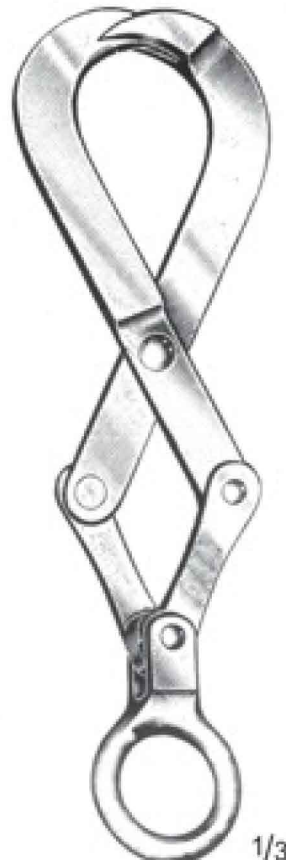

Krey-Schottler
SI-1173
21 cm, 8¼"
(kocher)

Obstetric Instruments & Hospital Scissors

Eyehooks

Double Obstetric Hooks



1/2

Ostertag
SI-1176
6½ cm, 2½"
blunt



1/2

Harms
SI-1177
8 cm, 3⅛"
blunt



1/2

Harms
SI-1178
8 cm, 3⅛"
sharp



1/3

Ruggeberg
SI-1179
14 cm, 5½"



1/3

Vienna Pattern
SI-1180
14 cm, 5½"



Obstetric Hook

SI-1181

For pig, in sizes 43 cm & 77 cm available in sharp/blunt.
(Our fast moving item)



Hospital-Household Paper Scissors

SI-1182

Heavy pattern German type, bright finish
available in sharp/blunt.

(Our fast moving item)

size: 6," 7", 8", 9", 10"



Linde
SI-1183
10½ cm, 4 1/8"
Finger Knife

1/2

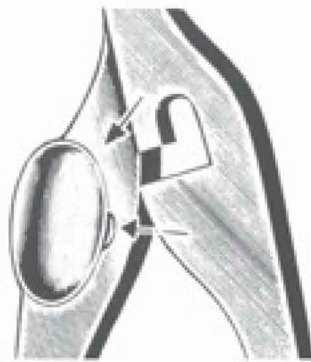

Special bayonet lock



1/8

Kuhn
SI-1184
84 cm, 33"
Obstetric crutch

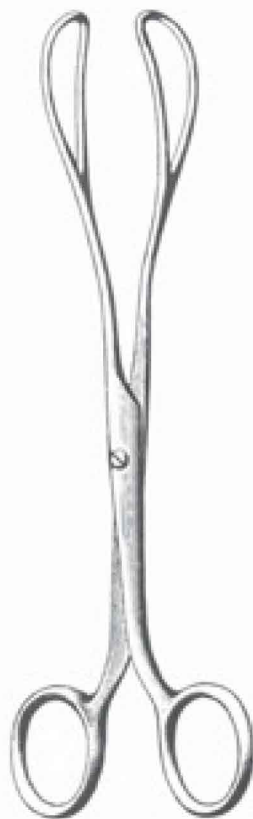

1/3

Obstetric Forceps
SI-1185
20 cm, 8"
For whelps, Danish pattern

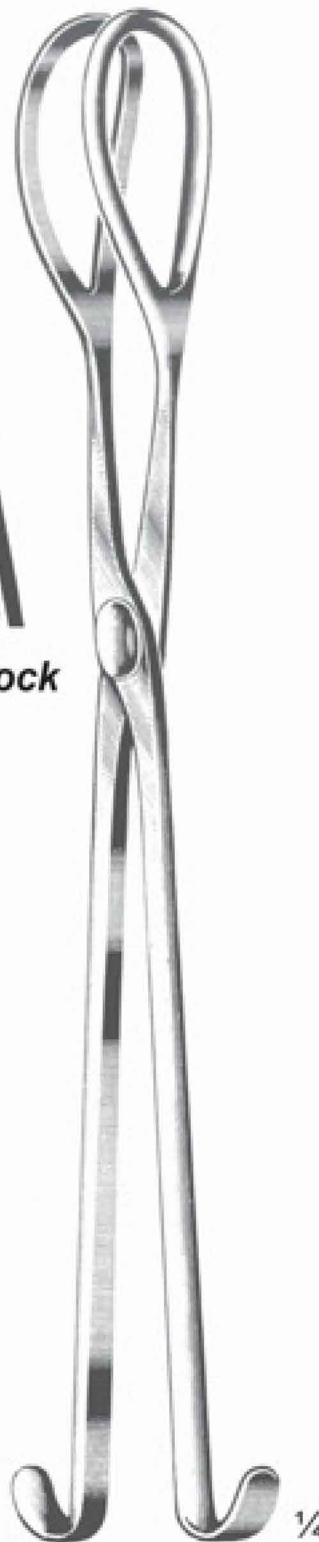

1/4

Witt
SI-1186
52 cm, 20½"
Obstetric forceps
for pigs

1. Pair of rubber pads

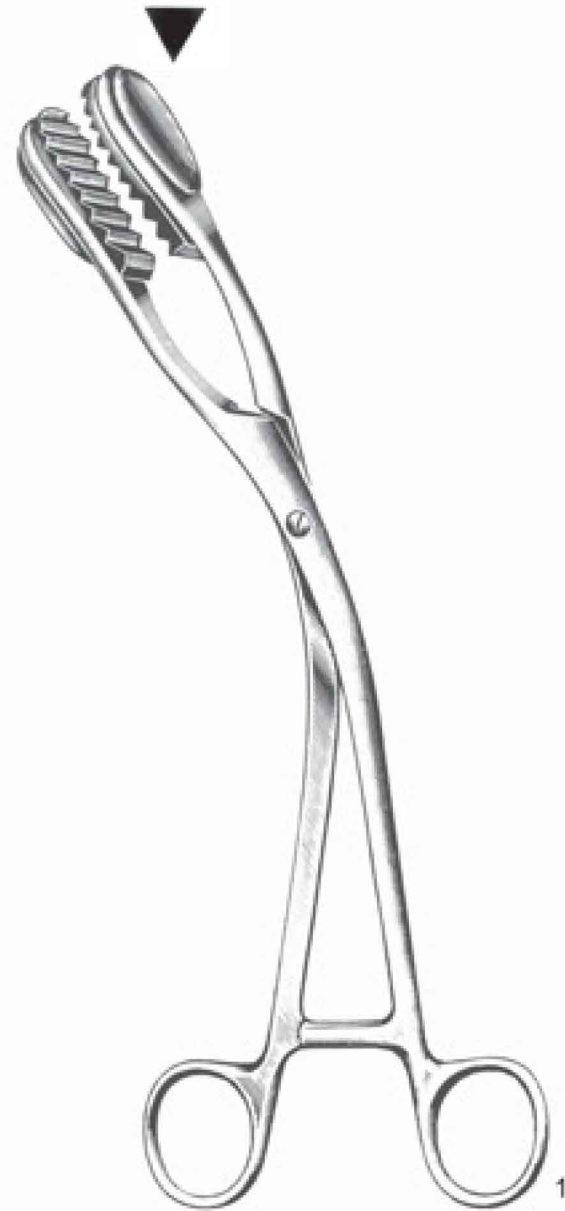

1/3

Uterine Elevating Forceps
SI-1187
28 cm, 11"
Curved sideways, with
inserted serrated rubber jaws.
used as clamping forceps for
perforation of the vagina.
This forceps can also be used
for caesarean section.

SI-1188
Spare Rubber for
Uterine Elevating Forceps

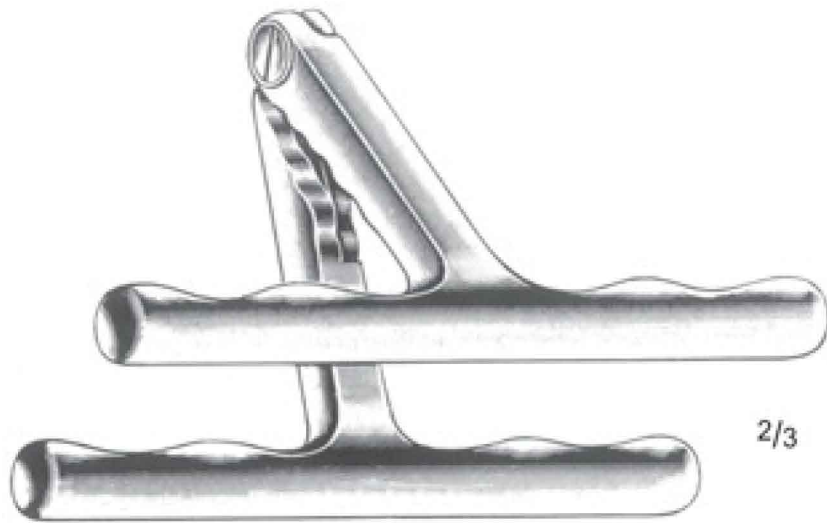

Jacks Handle
SI-1189
Folding handle for saw wire
stainless steel



Swedish Wire Handle
SI-1190
stainless steel



Obstetric Handle With Chain
SI-1191

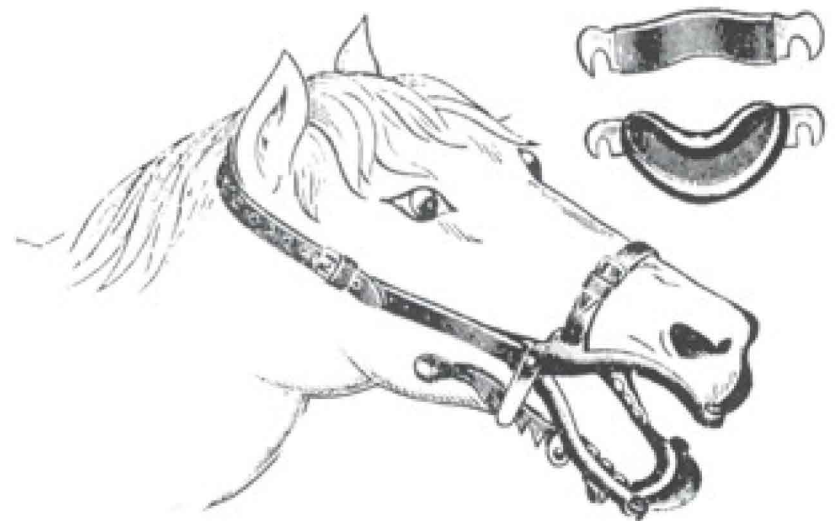

Hausmann
SI-1192
Horse Mouth Gags superior quality with one pair mouth plates grooved for use when dealing with molars, and one pair mouth plates flat, leather Straps, Made in Stainless Steel (our very popular and well known item in the world)

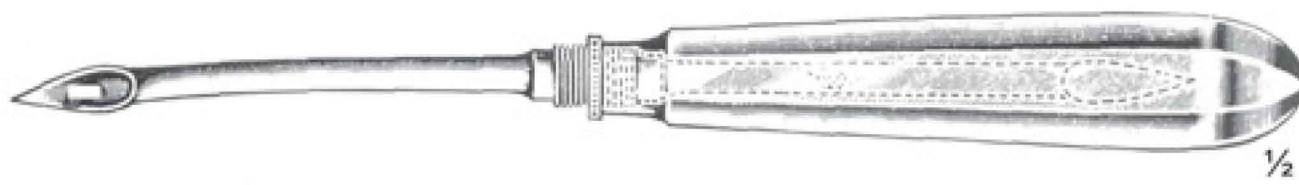

Flessa Needle
SI-1193
With hard point two pieces hollow
Stainless Steel Handle



Hollow
SI-1194
Stainless steel handle



Needle with Eye
SI-1195
Made of Stainless Steel

Scalpels



SI-1199
stainless steel

SI-1200
stainless steel



Noyes
SI-1196
12 cm, 4½"

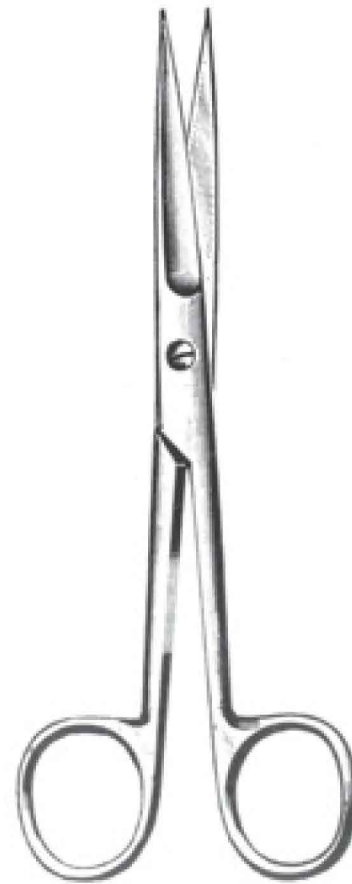

SI-1197
13 cm, 5"
str



SI-1298
13 cm, 5"
cvd

Trichinosis Scissors



Razor
SI-1201
Plastic handle
stainless steel blade



SI-1202
11 cm, 4¼"
str/cvd

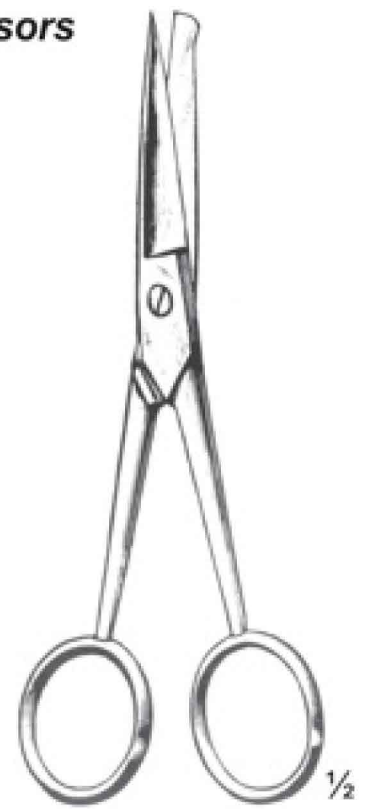

SI-1203
13 cm, 5"

Teat Instruments

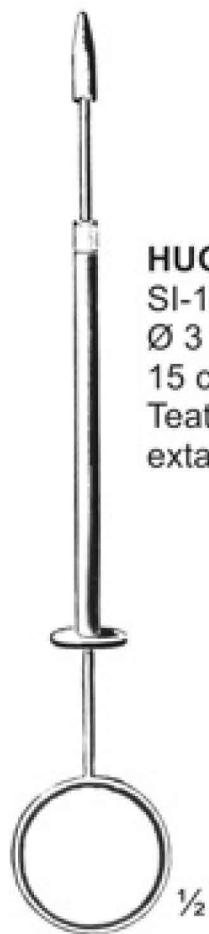

HUG
SI-1204
Ø 3 mm
15 cm, 6"
Teat tumor
extactor



Paimans
SI-1205
Ø 4 mm
13 cm, 5"
Teat Dilator

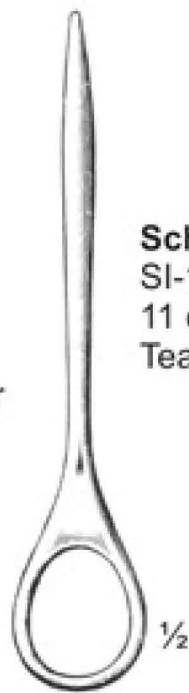

Schecker
SI-1206
11 cm, 4½"
Teat Dilator



Ullner
SI-1207
Teat curette
17 cm, 6¾"



Teat Slitter,
SI-1208
French Pattern
10 cm, 4"



Teat Dilator
SI-1209
With screw
14½ cm, 5¾"



Hug
Teat Lancet
SI-1210
15½ cm, 6 1/8"

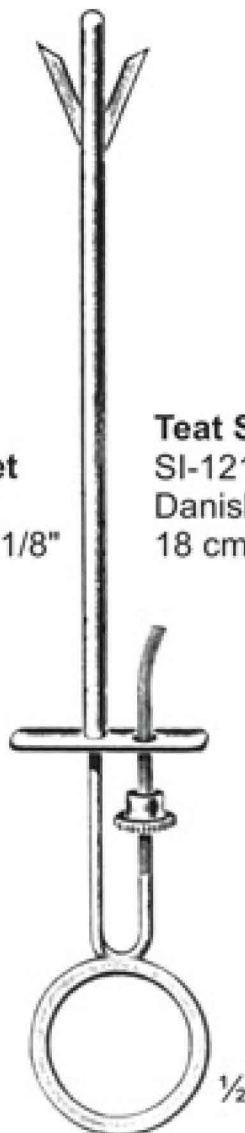

Teat Slitter
SI-1211
Danish pattern
18 cm, 7"

Microscopic Forceps (fine point)



SI-1212
10½ cm, 4¼"
SI-1213
13 cm, 5"
SI-1214
14½ cm, 5¾"
str

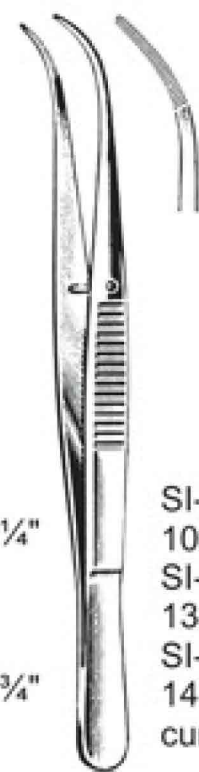

SI-1215
10½ cm, 4¼"
SI-1216
13 cm, 5"
SI-1217
14½ cm, 5¾"
curved

Instruments for Meat Inspection

Wire Cutters

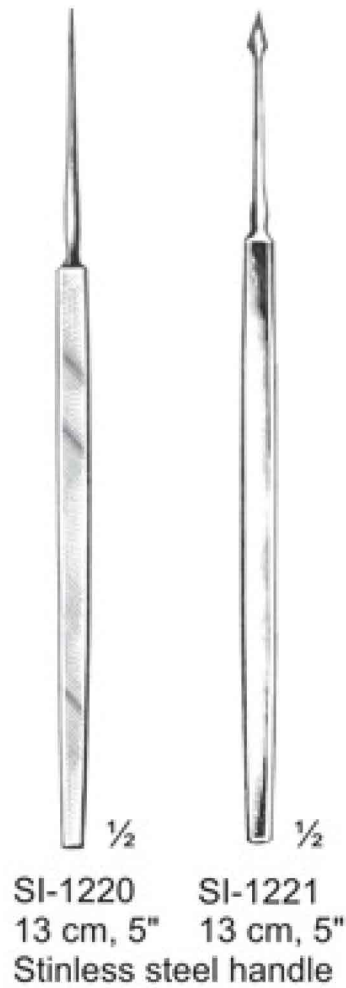

Clip Applying Forceps



Clip Applying & Removing Forceps

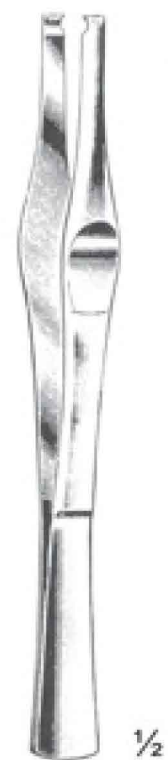

Scalpel Handle Interchangeable Blade (B. P. Handles)



All stainless steel

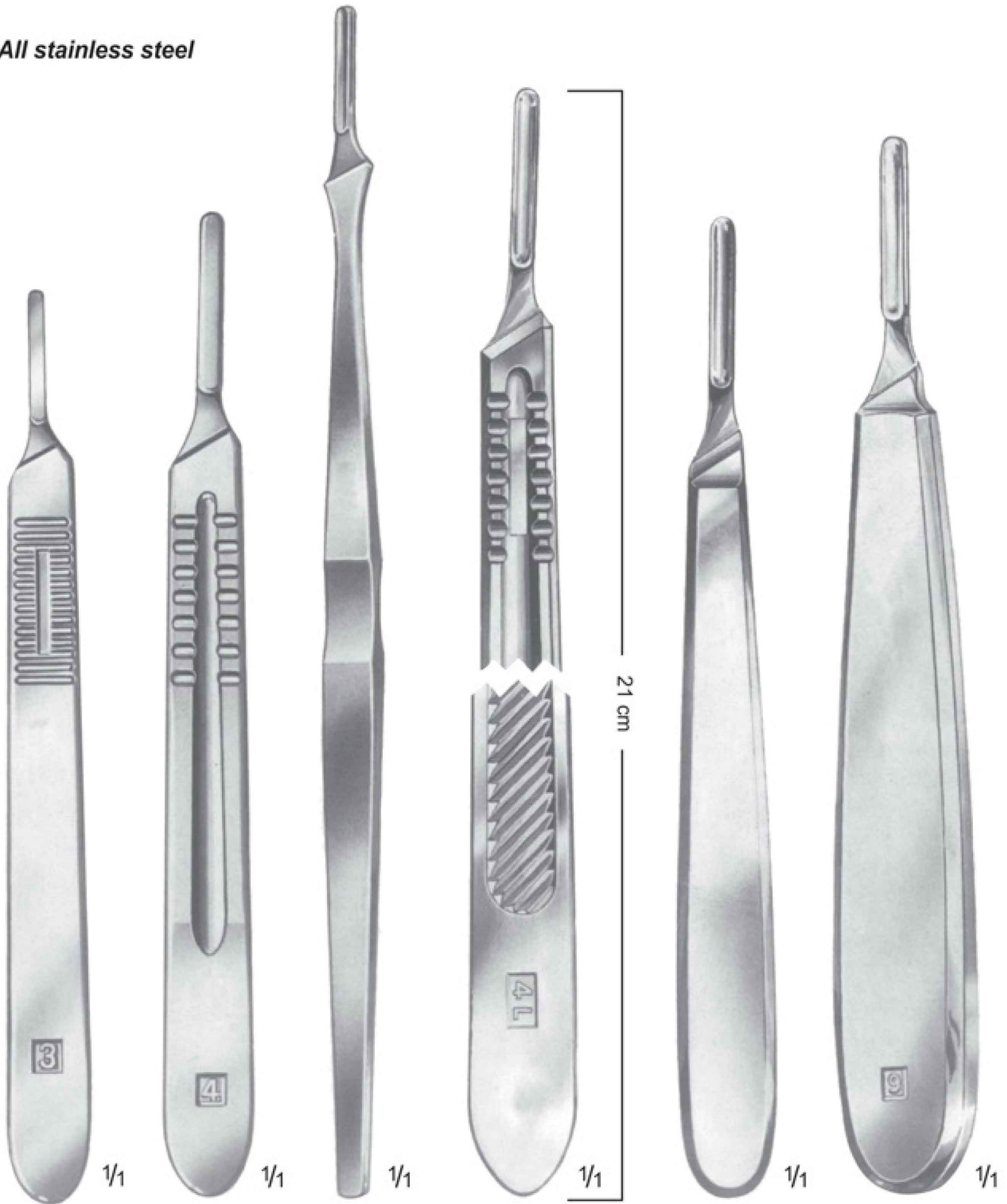

SI-1229
No. 3

1/1

SI-1230
No. 4

1/1

SI-1231
No. 7

1/1

SI-1232
No. 4L 21 cm, 8 1/2"

1/1

21 cm

SI-1233
No. 8

1/1

SI-1234
No. 9

1/1

Quality Veterinary Instruments



Gunther
SI-1235
Tooth forceps for large animals



Tooth Rasp
SI-1236
55 cm, 22"
With interchangeable blade
single piece



Tooth Rasp
SI-1237
For lower jaws with interchangeable
blade, rasp surface on one side and
the file on the other side, **Folding**
(two pieces) straight or bended



SI-1238
Forceps for trimming teeth

Dental Forceps



Molar Forceps
SI-1239
48cm, Serrated, short jaw
box joint, stainless steel
with knurled handles

Molar Forceps
SI-1240
48cm, conclave, long jaw
box joint, stainless steel
with knurled handles

Molar Forceps
SI-1241
46cm, short jaw, box joint
stainless steel with knurled
handles

Dental Forceps



Molar Forceps
SI-1242
48cm, three root,
box joint, "off side"
stainless steel
with knurled handles



Molar Forceps
SI-1243
48cm, three root,
box joint, "on side"
stainless steel
with knurled handles



Molar Forceps
SI-1244
48cm, molar spreader
box joint, stainless steel
with knurled handles



Extractor Reynolds Style
SI-1245
43cm, heavy model

Dental Forceps



Extractor Reynolds Style
SI-1246
43cm, heavy model
Lower

Lower Molar Cutter
SI-1248
56cm, simple joint
hardened, stainless steel
slightly opened head



Lower Molar Cutter
SI-1247
56cm, simple joint, hardened
stainless steel



Tooth Forceps
SI-1249
25cm, Incisor and
Canine Cutter

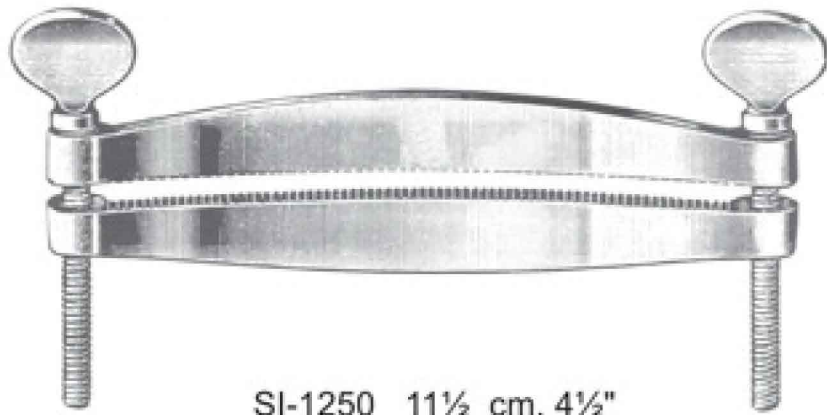

SI-1250 11½ cm, 4½"
SI-1251 15½ cm, 6 1/8"

Ear clamps for docking, curved, of light metal.



SI-1252 15½ cm, 6 1/8"

Ear clamp for dogs, Straight, of light metal.

Instruments for Dog's Care

All made of Stainless Steel

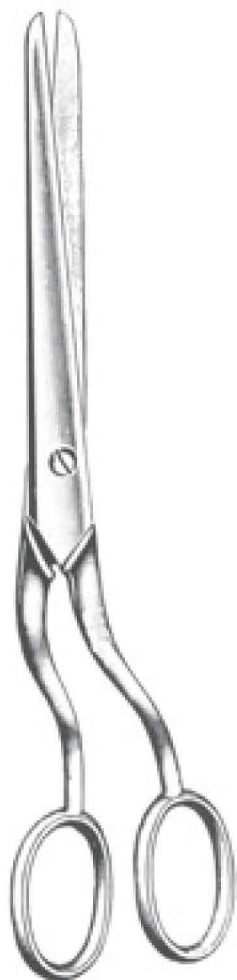

SI-1253
17 cm, 6¾"
Scissors



SI-1254
13 cm, 5"
16 cm, 6¼"
Scissors



SI-1255
17 cm, 6¾"
Curved on flat
Scissors

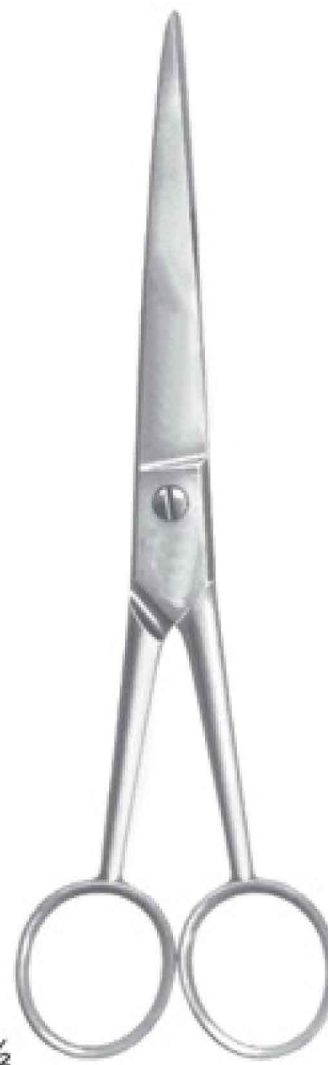

SI-1256
17 cm, 6¾"
Straight
Scissors



SI-1257
6", 6 ½", 7", 7 ½"
Thinning Scissors

Clippers for Shears



Doyen Clamp
SI-1260
24 cm, 9½"
For the operation to correct dog's ears
Straight/Curved



Cattle Clippers
SI-1258
Narrow toothed



Cattle and Dog Clippers
SI-1259
Strong model, wide toothed

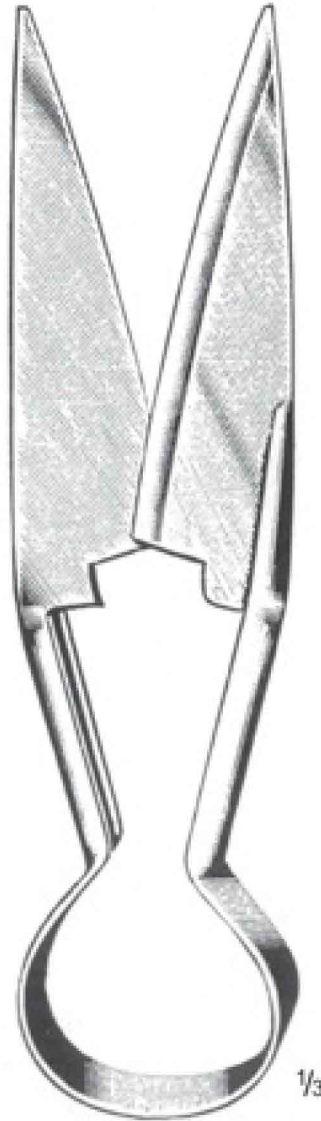

Sheep Shear
SI-1261
A. Large size 14"
B. Small size 12"

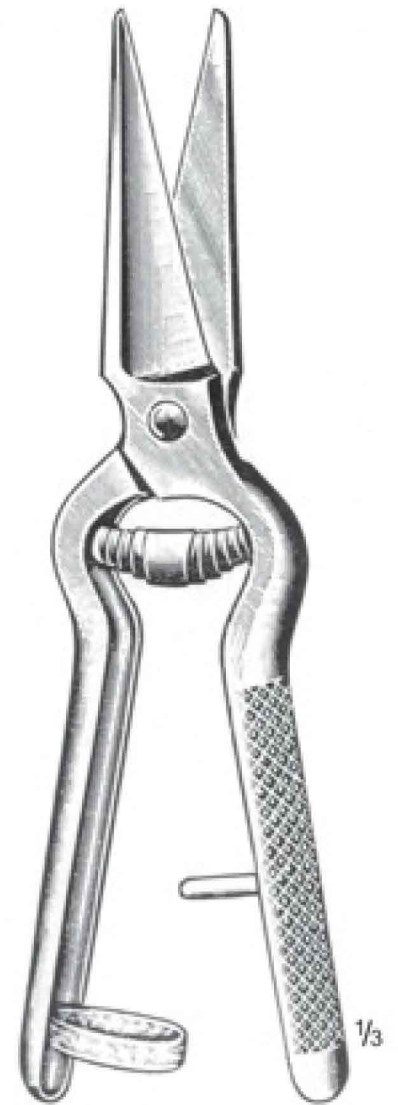

Hoof Shears
SI-1262
For sheep 8", 9", 9½"
Available in several models
Straight or side curved

Sterilizing Forceps



Sterilizing Tweezers,
SI-1263
For picking-up
syringes or cannula
A. 16 cm, 6¼"
B. 22½ cm, 8¾"

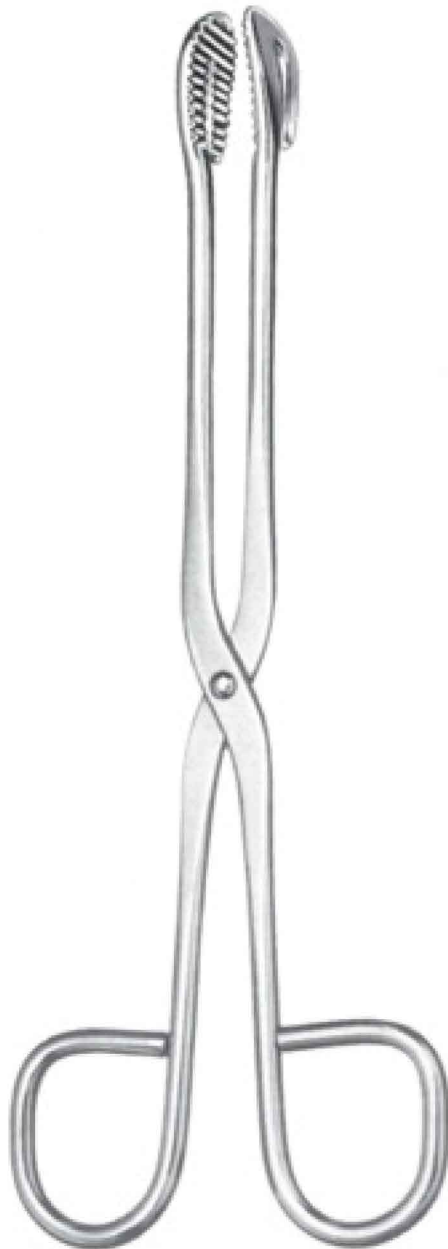

SI-1264
A. 20 cm, 8"
B. 30 cm, 12"



**Forceps With
Interlocking Jaws**
SI-1265
A. 20 cm, 8"
B. 30 cm, 12"



ROGGE
SI-1266
Sterilizing Forceps
23½ cm, 9½"

Bandage Scissors & Plaster Shears With or Without Carbide Tips & Gold Plated Handle

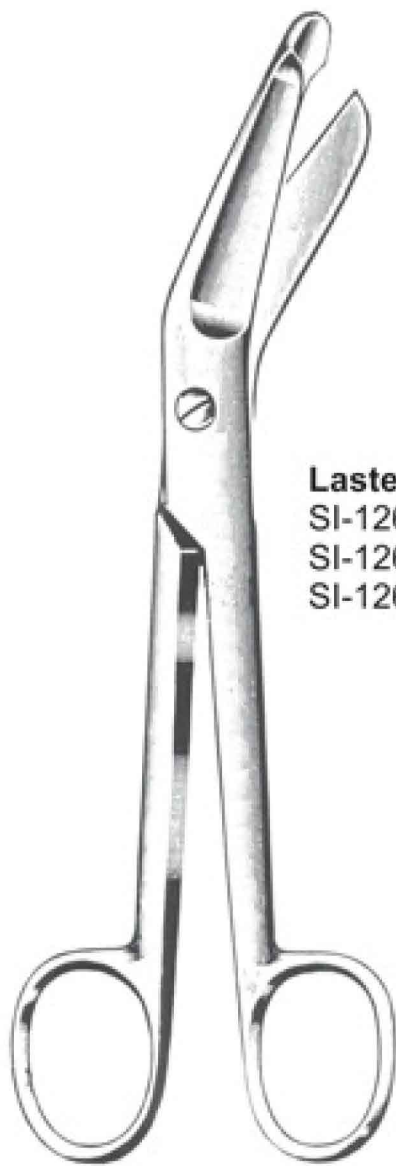

Laster
SI-1267 14 cm, 5½"
SI-1268 18 cm, 7"
SI-1269 20 cm, 8"

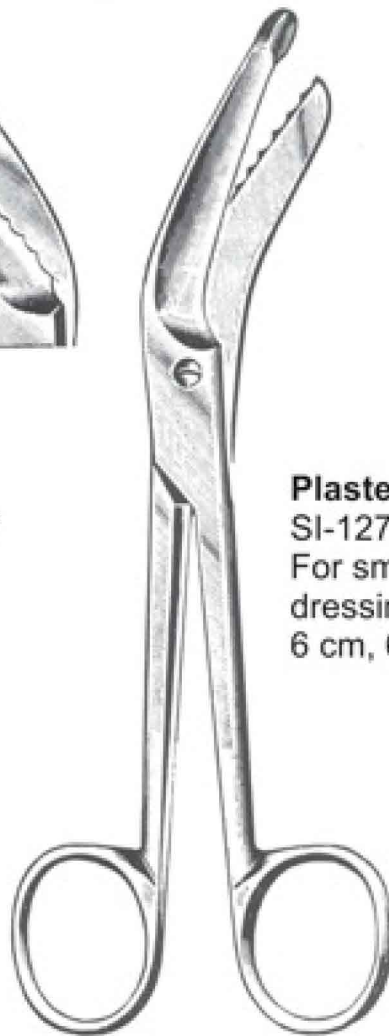

Plaster Scissors
SI-1270
For small plaster dressings
6 cm, 6¼"



SI-1271
Hospital Household-paper (tailor) Scissors
size: 6", 7", 8", 9", 10"
Available in black painted handle or only in plain bright finish & satin finish



Richter
SI-1272
14½ cm, 5¾"
Laterally Angled



SI-1273
16 cm, 6¼"
Laterally Curved

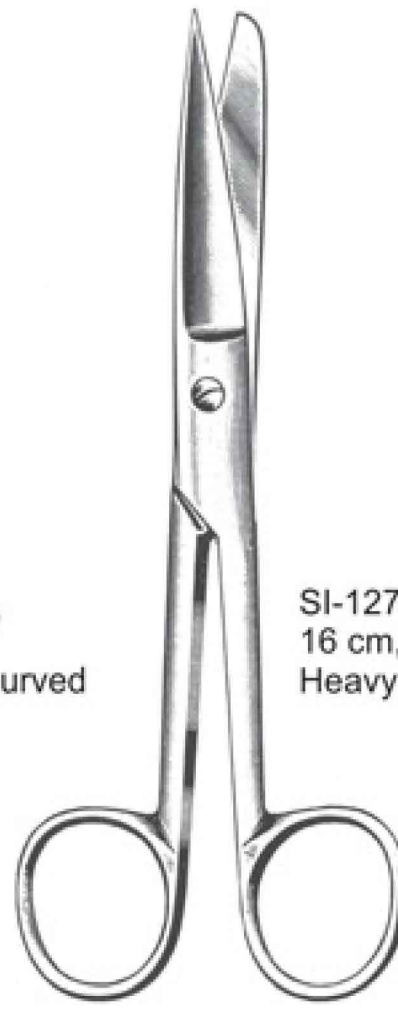

SI-1274
16 cm, 6¼"
Heavy Pattern

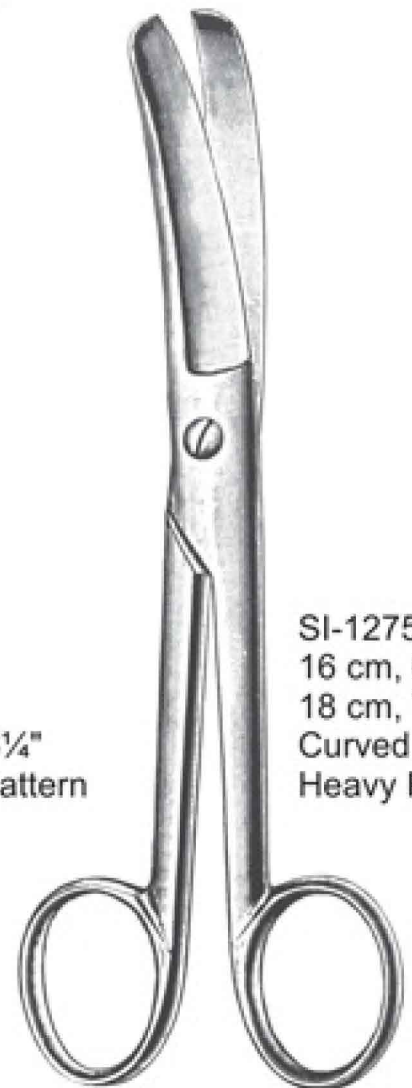

SI-1275
16 cm, 6¼"
18 cm, 7"
Curved on flat
Heavy Pattern

Surgical Scissors With or Without Carbide Tips & Gold Plated Handle

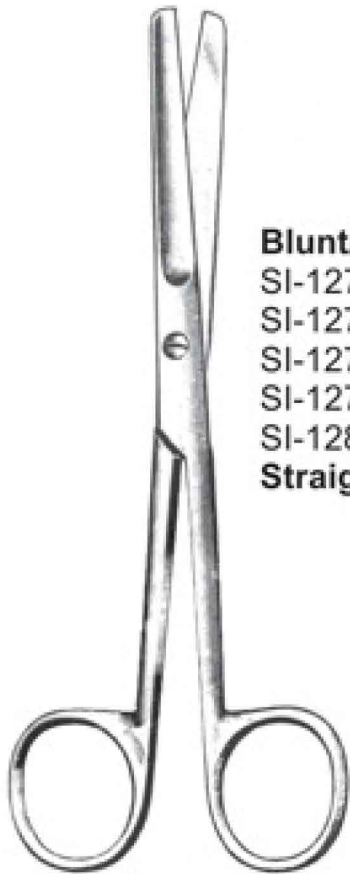

Blunt/Blunt

SI-1276 13 cm, 5"
SI-1277 14½ cm, 5¾"
SI-1278 15¼ cm, 6"
SI-1279 16½ cm, 6½"
SI-1280 17½ cm, 7"
Straight / Curved

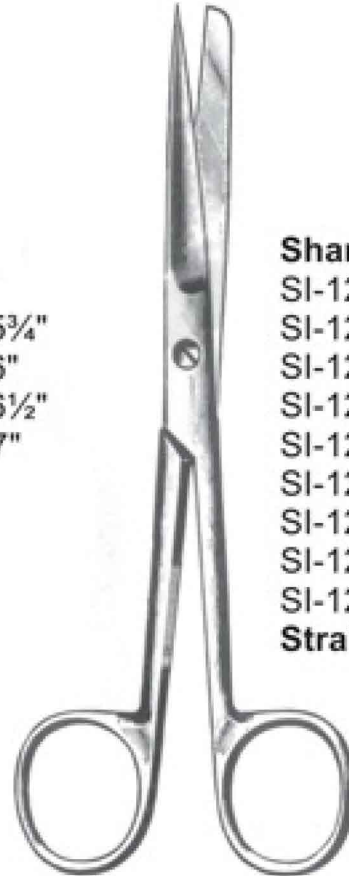

Sharp / Blunt

SI-1281 10½ cm, 4"
SI-1282 11½ cm, 4½"
SI-1283 13 cm, 5"
SI-1284 14½ cm, 5½"
SI-1285 15¼ cm, 6"
SI-1286 16½ cm, 6½"
SI-1287 17½ cm, 7"
SI-1288 18½ cm, 7¼"
SI-1289 20 cm, 8"
Straight / Curved

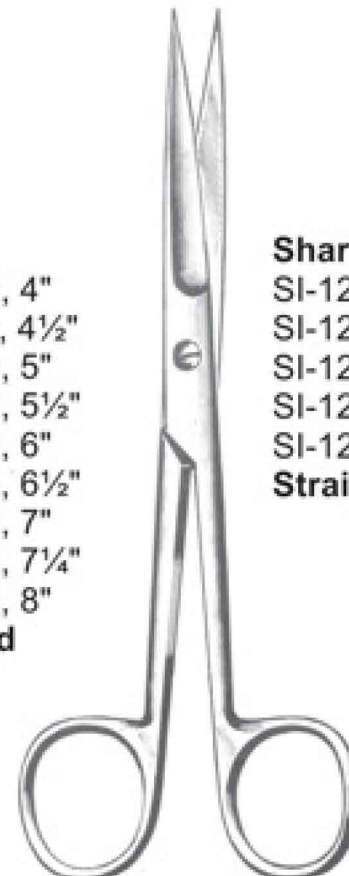

Sharp / Sharp

SI-1290 11½ cm, 4½"
SI-1291 13 cm, 5"
SI-1292 14½ cm, 5¾"
SI-1293 15¼ cm, 6"
SI-1294 16½ cm, 6½"
Straight / Curved

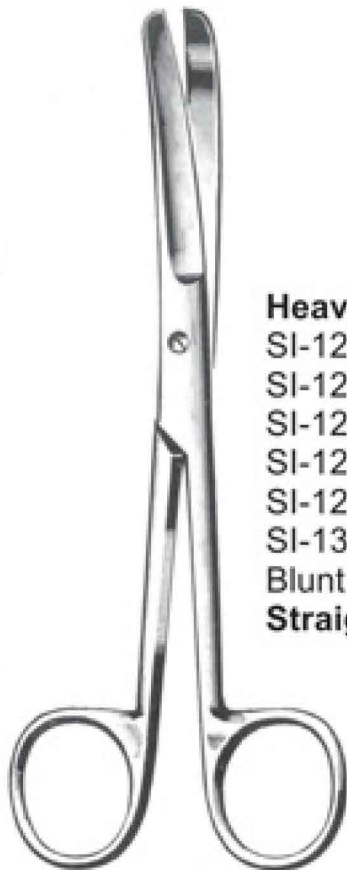

Heavy Pattern

SI-1295 11½ cm, 4½"
SI-1296 13 cm, 5"
SI-1297 14½ cm, 5¾"
SI-1298 15¼ cm, 6"
SI-1299 16½ cm, 6½"
SI-1300 17½ cm, 7"
Blunt / Blunt
Straight / Curved

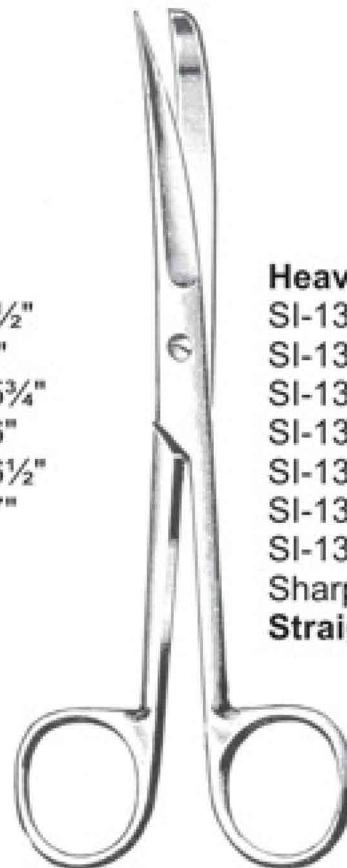

Heavy Patten

SI-1301 11½ cm, 4½"
SI-1302 13 cm, 5"
SI-1303 14½ cm, 5¾"
SI-1304 15¼ cm, 6"
SI-1305 16½ cm, 6½"
SI-1306 17½ cm, 7"
SI-1307 18½ cm, 7¼"
Sharp / Blunt
Straight / Curved

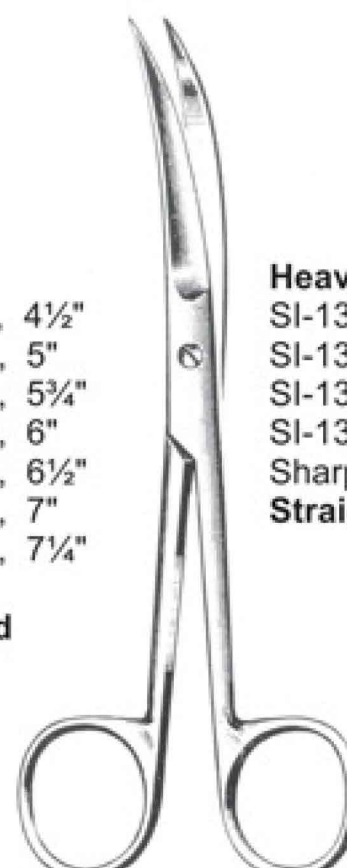

Heavy Patten

SI-1308 11½ cm, 4½"
SI-1309 13 cm, 5"
SI-1310 14½ cm, 5¾"
SI-1311 15¼ cm, 6"
Sharp / Sharp
Straight / Curved

Surgical Scissors & Forceps With or Without Carbide Tips & Gold Plated Handle



Incision Scissors
SI-1312 13 cm, 5"
SI-1313 14½ cm, 5¾"
SI-1314 16½ cm, 6½"
Straight / Curved

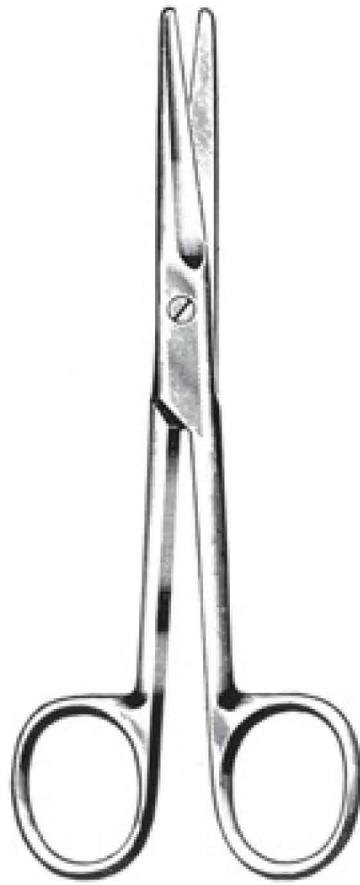

Mayo
SI-1315 14 cm, 5½"
SI-1316 15 cm, 6"
SI-1317 17 cm, 6¾"
Straight

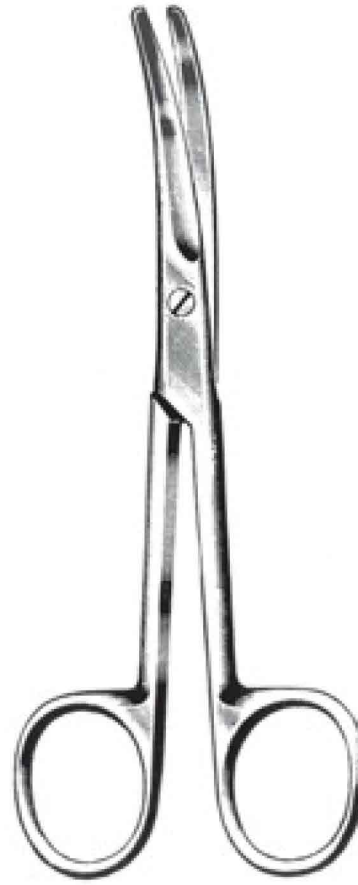

Mayo
SI-1318 14 cm, 5½"
SI-1319 15½ cm, 6"
SI-1320 17 cm, 6¾"
Curved

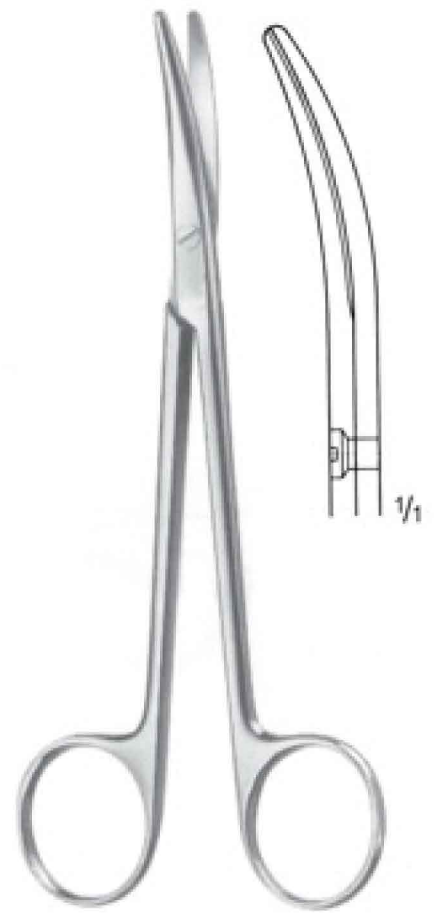

Metzenbaum
SI-1321 16½ cm, 5¾"
SI-1322 19½ cm, 7"
SI-1323 21 cm, 8"
Straight / Curved



Utility Scissors
SI-1324
18 cm, 7"



Baby Utility Scissors
SI-1325
14 cm, 5½"

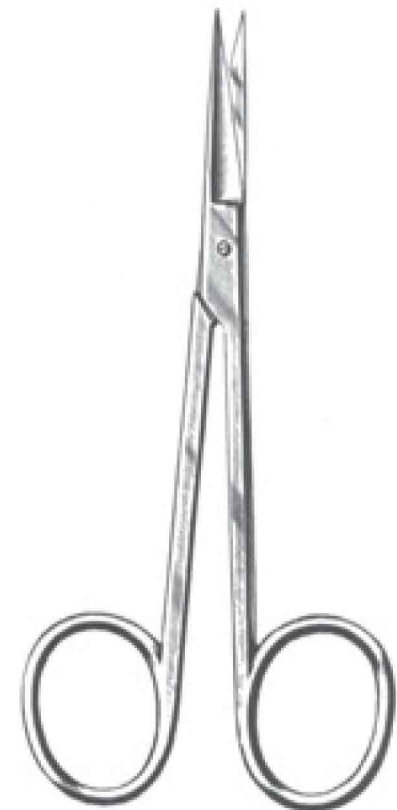

Iris Scissors
SI-1326
11½ cm, 4½"

Note: We are also making utility scissors with plastic handle for all purposes in size 4", 4½"

Delicate Scissors

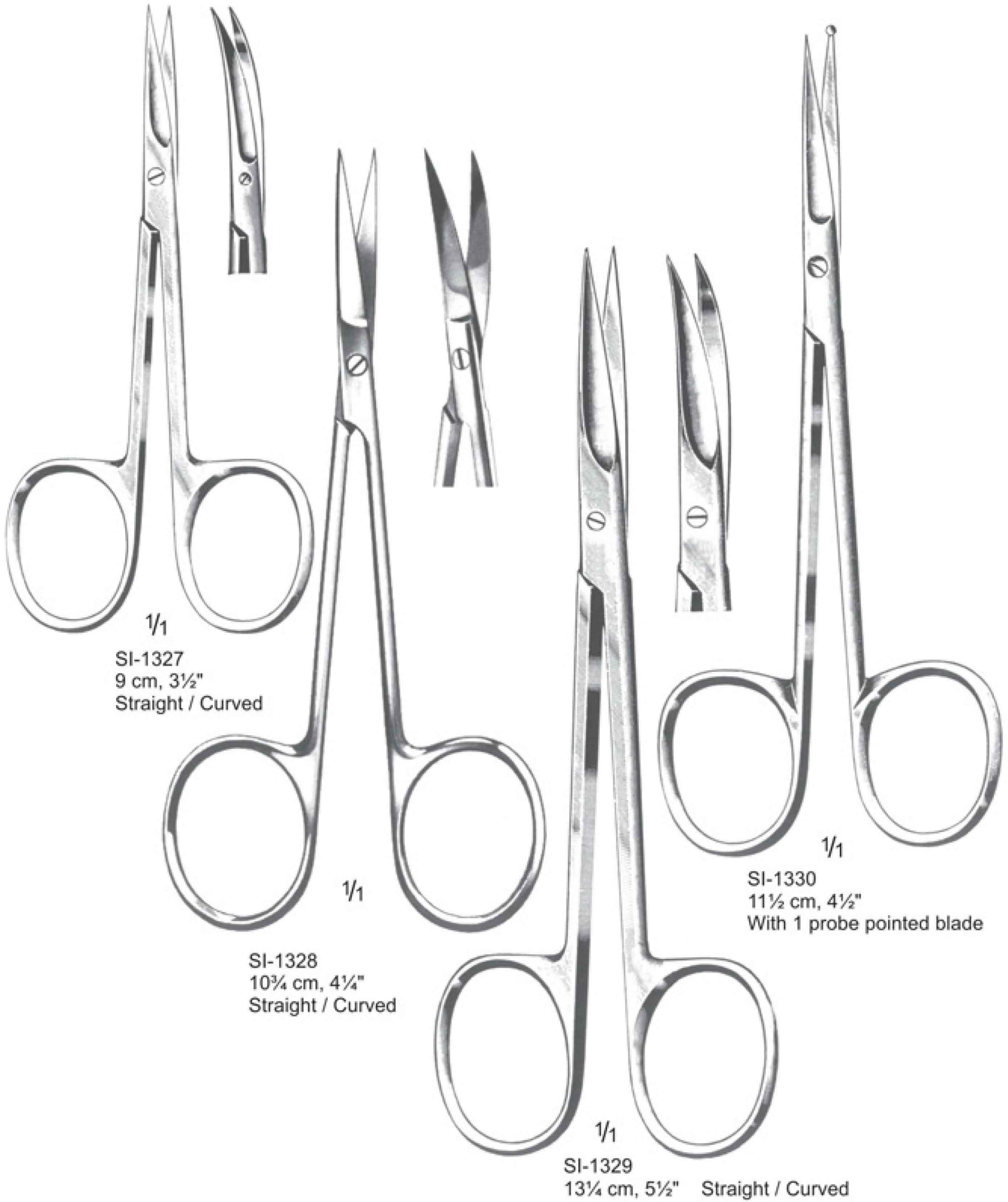

1/1
SI-1327
9 cm, 3½"
Straight / Curved

1/1
SI-1328
10¾ cm, 4¼"
Straight / Curved

1/1
SI-1329
13¼ cm, 5½"
Straight / Curved

1/1
SI-1330
11½ cm, 4½"
With 1 probe pointed blade

Dressing Forceps

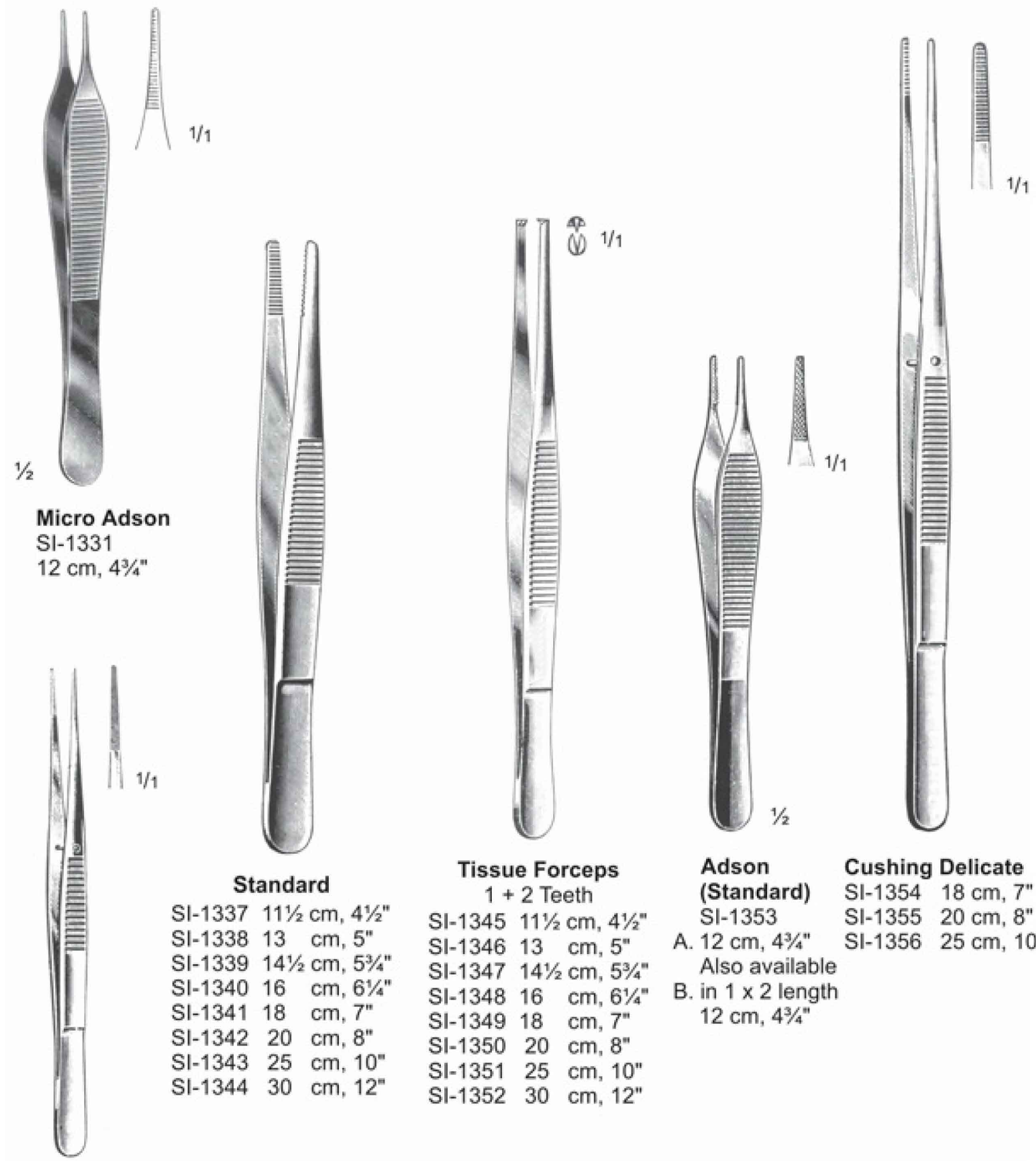

Micro Adson
SI-1331
12 cm, 4³/₄"

Standard

SI-1337	11½ cm, 4½"
SI-1338	13 cm, 5"
SI-1339	14½ cm, 5¾"
SI-1340	16 cm, 6¼"
SI-1341	18 cm, 7"
SI-1342	20 cm, 8"
SI-1343	25 cm, 10"
SI-1344	30 cm, 12"

Tissue Forceps
1 + 2 Teeth

SI-1345	11½ cm, 4½"
SI-1346	13 cm, 5"
SI-1347	14½ cm, 5¾"
SI-1348	16 cm, 6¼"
SI-1349	18 cm, 7"
SI-1350	20 cm, 8"
SI-1351	25 cm, 10"
SI-1352	30 cm, 12"

Adson (Standard)
SI-1353

A. 12 cm, 4³/₄"
Also available
B. in 1 x 2 length
12 cm, 4³/₄"

Cushing Delicate

SI-1354	18 cm, 7"
SI-1355	20 cm, 8"
SI-1356	25 cm, 10"

Very Delicate

SI-1332	9 cm, 3½"
SI-1333	10½ cm, 4¼"
SI-1334	11½ cm, 4½"
SI-1335	13 cm, 5"
SI-1336	14½ cm, 5¾"

Note: We also make micro instruments.
We welcome your enquiries.



Chalazion Forceps
Desmarres
SI-1357
9 cm, fig. 2



Nictating Membrane Forceps
Stades
SI-1358
9.5 cm



Trachom roll Forceps
KNAPP
SI-1359
11 cm



Graefe Fixation Forceps
SI-1360
11 cm, with splint



SI-1361
11 cm, with lock



Hess
SI-1362
6.5 cm
double curved



Gill-Arruga
SI-1363
7.5 cm



Castroviejo
SI-1364 10 cm
teeth: 0.3 mm
SI-1365 10 cm
teeth: 0.5 mm



Tuebingen
SI-1366
10 cm



Arruga
SI-1367
10 cm



Utrata Titanium
SI-1368
10 cm



Graefe Iris Forceps
SI-1369
10 cm
Straight
Serrated



Graefe Iris Forceps
SI-1370
10 cm
Curved
Serrated



Graefe Iris Forceps
SI-1371
10 cm
Straight
1x2 teeth



Graefe Iris Forceps
SI-1372
10 cm
Curved
1x2 teeth



Iris Forceps
Hess
SI-1373
7 cm



Iris/Suture Forceps
Barraquer-Katzin
SI-1374
7 cm
teeth: 0,12 mm / 90°



Iris Forceps
Bishop-Harmon
SI-1375
8,5 cm
1x2 teeth



Capsule Forceps
Fuchs
SI-1376
7 cm



**Iris Scissors
Castroviejo**
SI-1377
10 cm
Straight / Curved



**Corneal Scissors
Castroviejo**
SI-1378
10 cm
Right, Curved



**Corneal Scissors
Castroviejo**
SI-1379
10 cm
Left, Curved



Tuebingen
SI-1380
8.5 cm
Sharp, Curved



**Castroviejo
Needle Holder**
SI-1381
14 cm
Straight, with ratchet



Barraquer-Troutman
SI-1382
11 cm
Curved, Round Handle
without ratchet



Boynton
SI-1383
12 cm
Straight, TC

Rongeurs



Rongeur Beyer
SI-1384
18 cm
Curved, Compound action



Schneidemann
SI-1385
15 cm
Laterally Curved, Compound Action

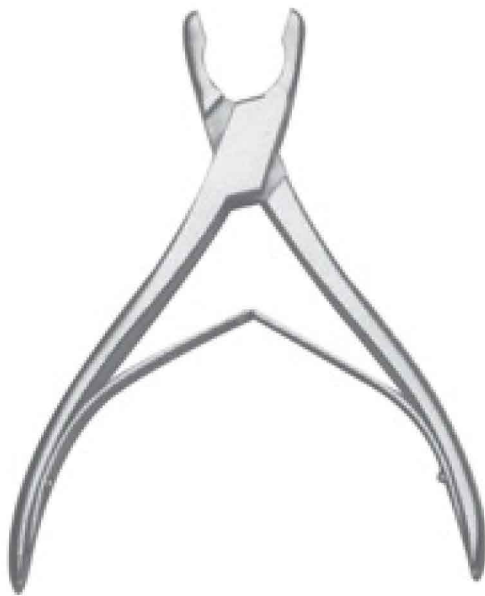

Luer
SI-1386
14 cm
Curved



Boehler
SI-1387
15 cm Straight
compound action



Boehler
SI-1388
15 cm Curved
compound action

Bone Holding Forceps



Meniscal Forceps
SI-1389
13 cm



Meniscal Knife
SI-1390
17 cm

Ferris-Smith
SI-1391
18 cm, 2 mm Shank
40° Upward Cutting Jaw



Bone Holding Forceps
SI-1392
13.5 cm



**Bone Holding Forceps
for Bone Screw**
SI-1393
15 cm



Setter Reduction Forceps
SI-1394
24 cm, with Serrated Jaws
and Spin Lock



Bone Holding Forceps
SI-1395
15 cm
Angled Jaw

Bone Holding Forceps



Kern-Mini
SI-1396
17 cm
with ratchet



Kern-Mini
SI-1397
17 cm
modified for small
bones with ratchet



**Bone Holding
Forceps**
SI-1398
15 cm
with spin lock



Lister
Bone Cutting Forceps
SI-1399
17 cm



Pin Cutter
SI-1400
21.5 cm TC
for hard wire up to
D = 2.2mm



Pin Cutter
SI-1401
22 cm TC
for soft wire up to D = 3.5mm
for hard wire up to D = 2.5mm



Plate & Wire Cutter
SI-1402
up to D = 3.5mm

K-Wire Cutter Hercules

Approved transmission of power. Rubber jaws keep the pin ends together after cutting

- Over 40% less power required
- Exchangeable TC-blades and rubber jaws



Hercules
SI-1403
23 cm TC
For pins up to D = 3mm

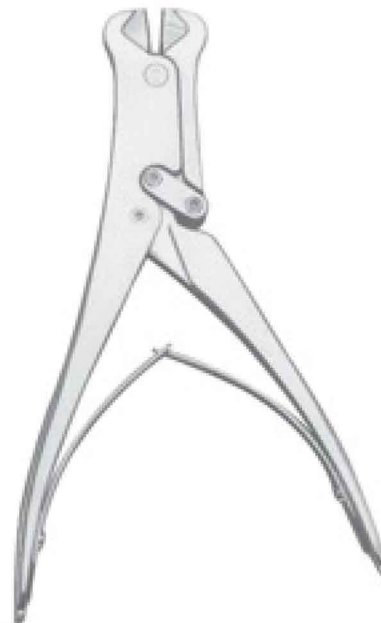

Hercules
SI-1404
18 cm TC
For pins up to D = 2.2mm

Flessa Pins

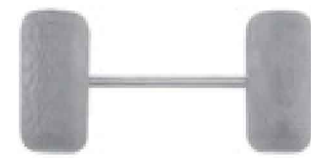

SI-1405
40 mm



SI-1406
50 mm



SI-1407
65 mm

Speculum

Specula for Small Animals, for Vaginal and Rectal Examination

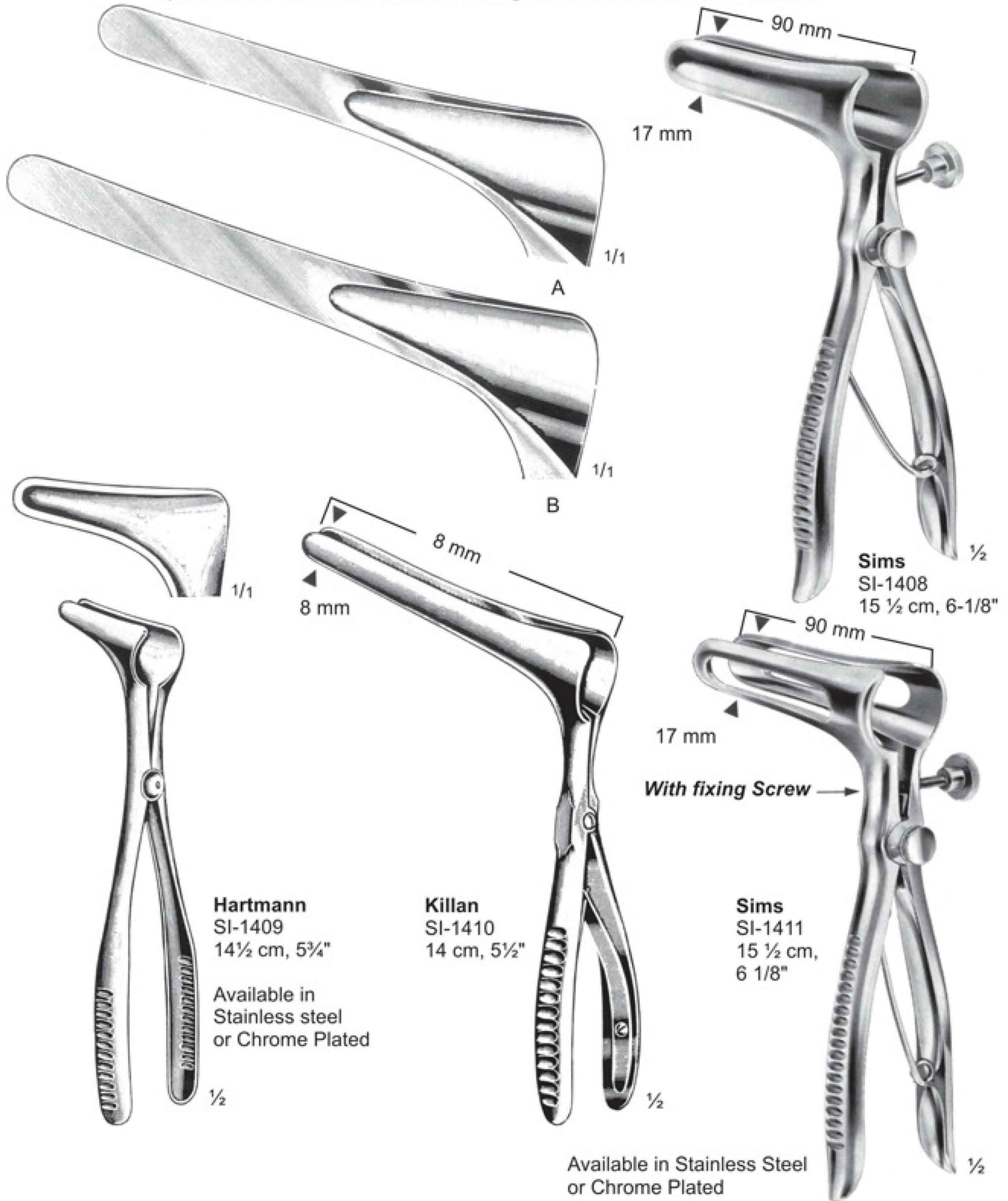

Diagnostic Instruments Laryngoscope



SI-1412
Laryngoscope
packed in a case.



Otoscope Set Economy
SI-1413
3 specula's with
D = 0,4 / 0,5 / 0,6mm
length: 4,5cm
Handle with battery



SI-1414
Set of 3 pieces
(D = 4, 6 and 9 mm)

SI-1415
Veterinary Long Cannula
D = 9mm length: 61mm

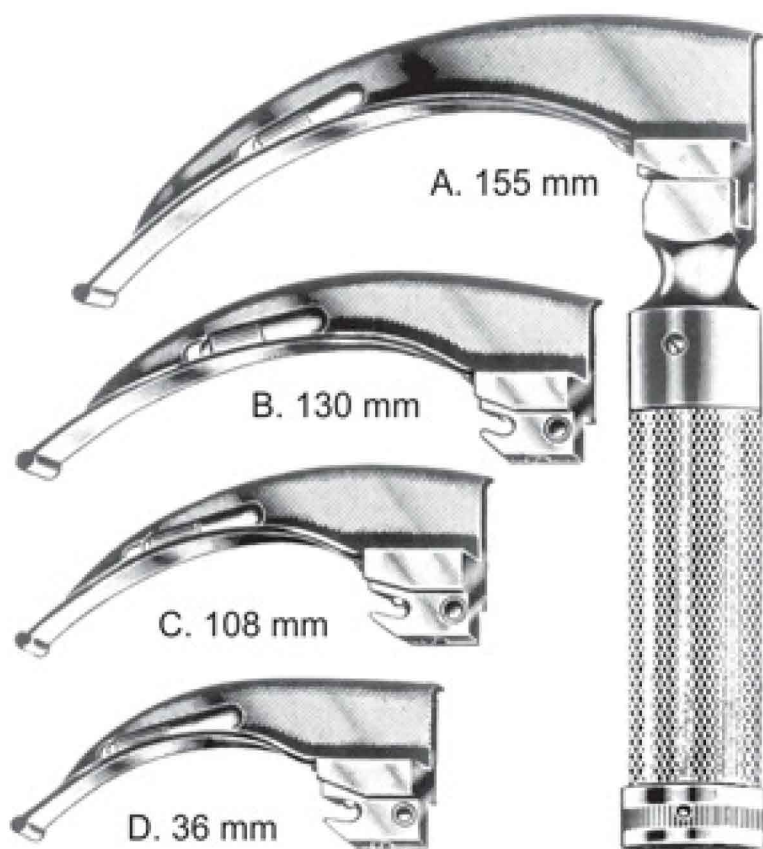

A. 155 mm

B. 130 mm

C. 108 mm

D. 36 mm

McIntosh
SI-1416
English Pattern

Complete with ball lock, consisting of batter handle. (without battery)
4 spatulas fix lamp-sacket packed in very attractive case, our product with guarantee.

Diagnostic Set & Accessories



Otoscope Set
SI-1417
Otoscope set in case, consisting of otoscope 3 ear specula and medium battery handle. our hot selling item.

Note : Also Available in Fiber Optic

Vaginal Speculum

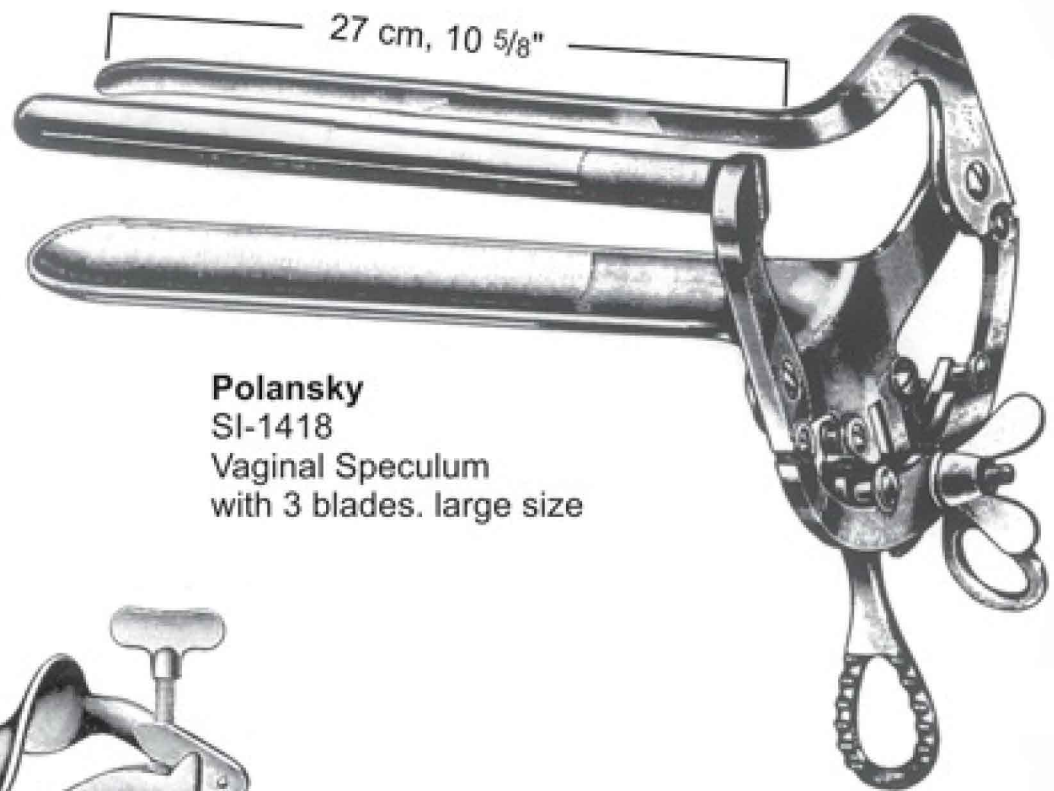

Polansky
SI-1418
Vaginal Speculum
with 3 blades. large size

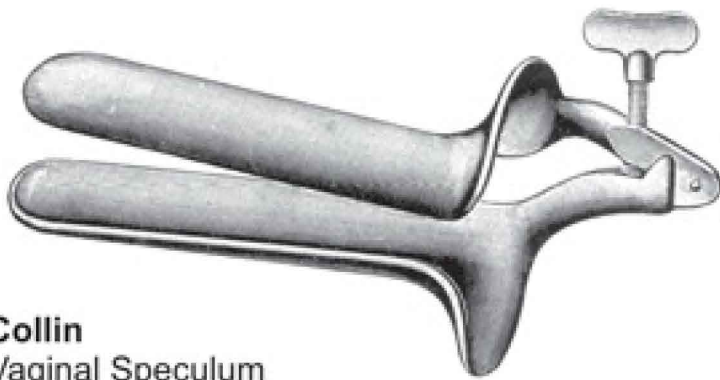

Collin
Vaginal Speculum

a mm	b mm		
85	25 S	SI-1419	
100	35 M	SI-1420	
110	40 L	SI-1421	



Polansky
SI-1422
Vaginal Speculum Large Size

Bright or Satin Finish

Bovine Vaginal Speculum



Grave
Vaginal Speculum
SI-1423 Small
SI-1424 Medium
SI-1425 Large

Bright or Satin Finish

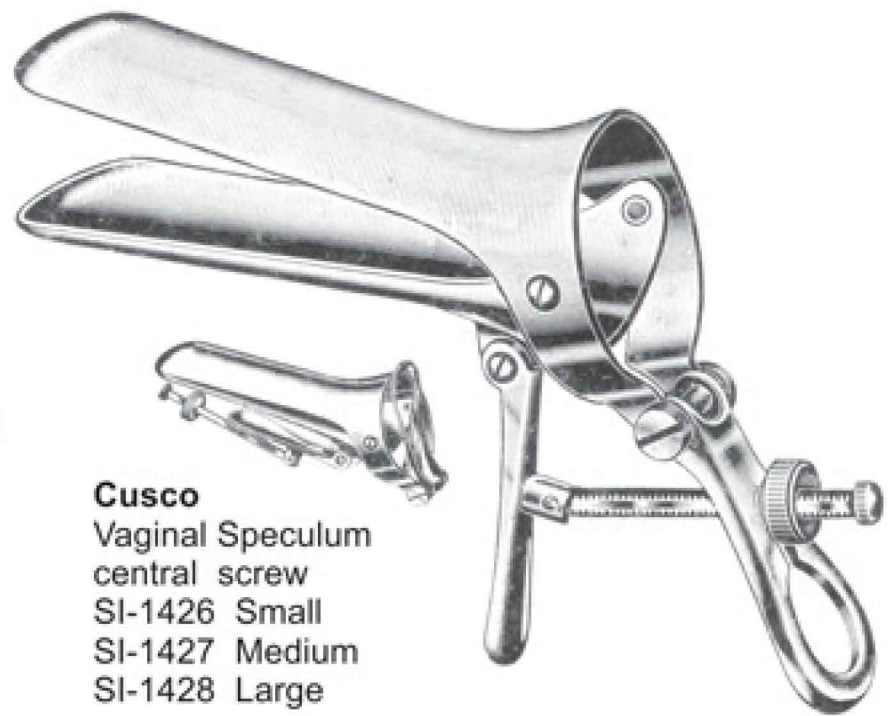

Cusco
Vaginal Speculum
central screw
SI-1426 Small
SI-1427 Medium
SI-1428 Large

Bright or Satin Finish

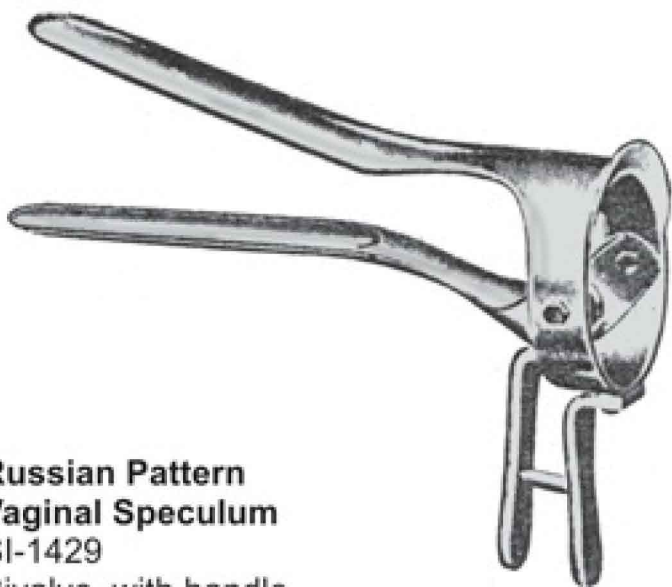

Russian Pattern
Vaginal Speculum
SI-1429

Bivalve, with handle,
heifer size, overall length 28 cm, 11"
stainless steel



Russian Pattern
Vaginal Speculum
SI-1430

Bivalve, with handle
cow size, overall length
35 cm 13 $\frac{3}{4}$ "
stainless steel

NOTE: Our factory can make any type of special vaginal speculum for your special requirements.



Torsion Fork
SI-1431
With fixation bar
Stainless Steel



Embryotomy Obstetric Instruments

SI-1432

- (A) Dividable Embryotome Model
- (B) Dividable wires thread needle
- (C) Embryotome cleaning brush



Brinths Teat Knife
SI-1433
With folding handle
Stainless Steel



Plums Infusion Canula
SI-1434
Available in
following sizes
6.0 x 90 mm,
2.4 x 80 mm,
3.0 x 80 mm,
Stainless Steel

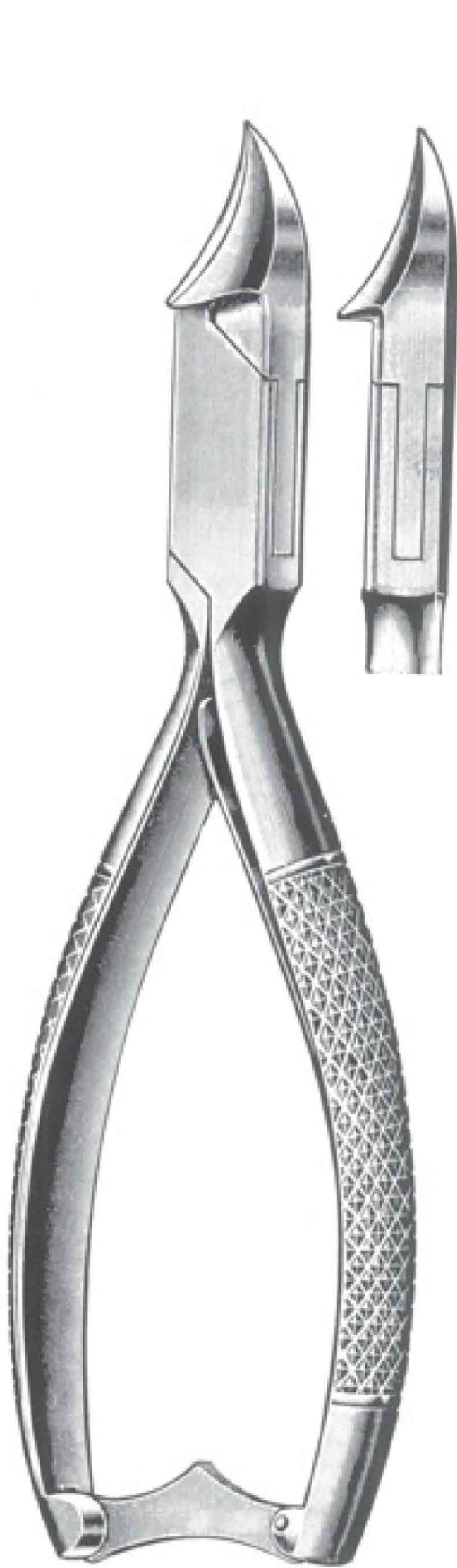

Nail Cutter
SI-1435
13½ cm, 5¼"
Stainless Steel



Nail Cutter
SI-1436
A. 13 cm, 5"
B. 14½"cm, 5¾"
Stainless steel



Nail Scissors
SI-1437 9 cm, 3½"
SI-1438 10 cm, 4"
SI-1439 11 cm, 4¾"
Curved in flat

Abdominal Retractors

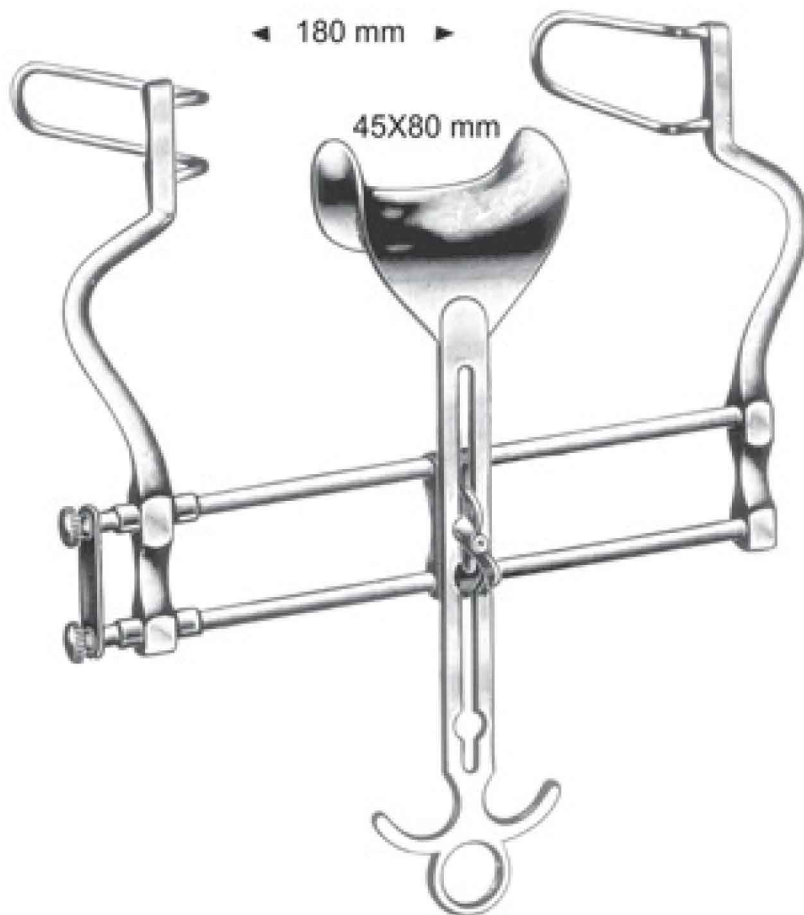

Balfour Retractor
SI-1440

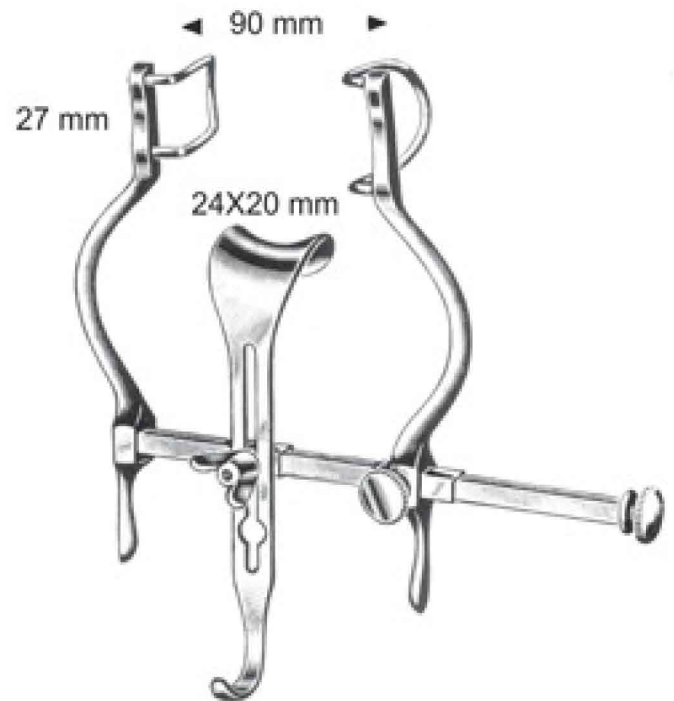

Balfour-Baby Retractor
SI-1441

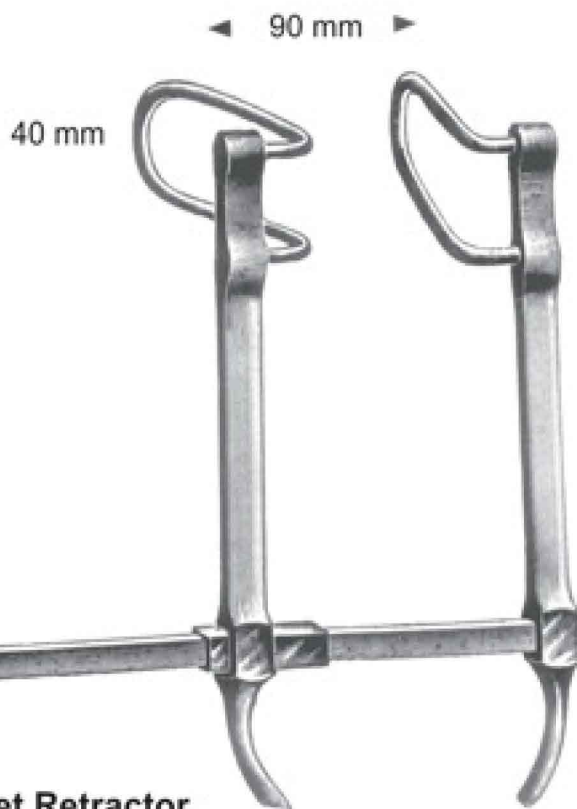

Gosset Retractor
SI-1442

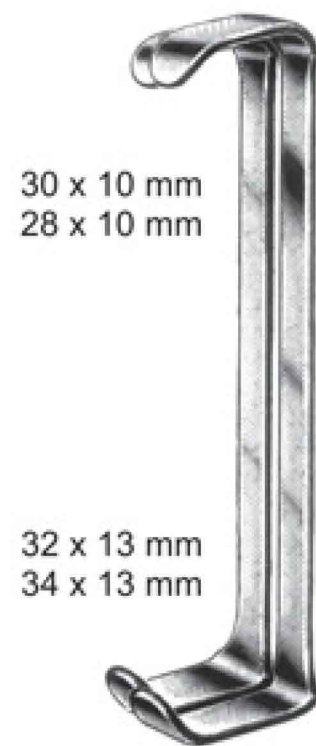

Farabeuf Retractor
SI-1443
Set of two
Stainless Steel

Tongue Forceps

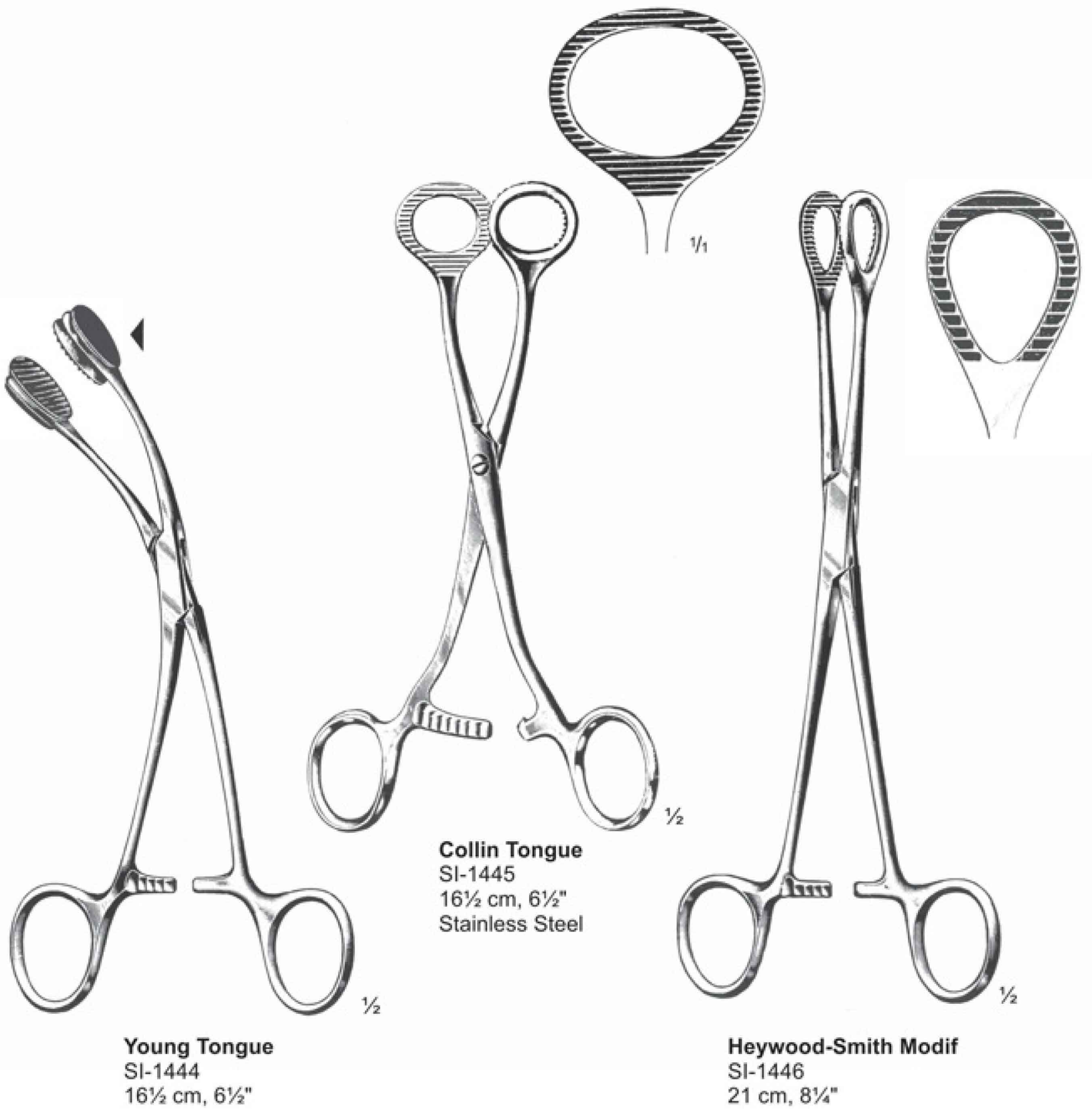

NOTE: Spare rubber are also available on demand

Bone Holding Forceps

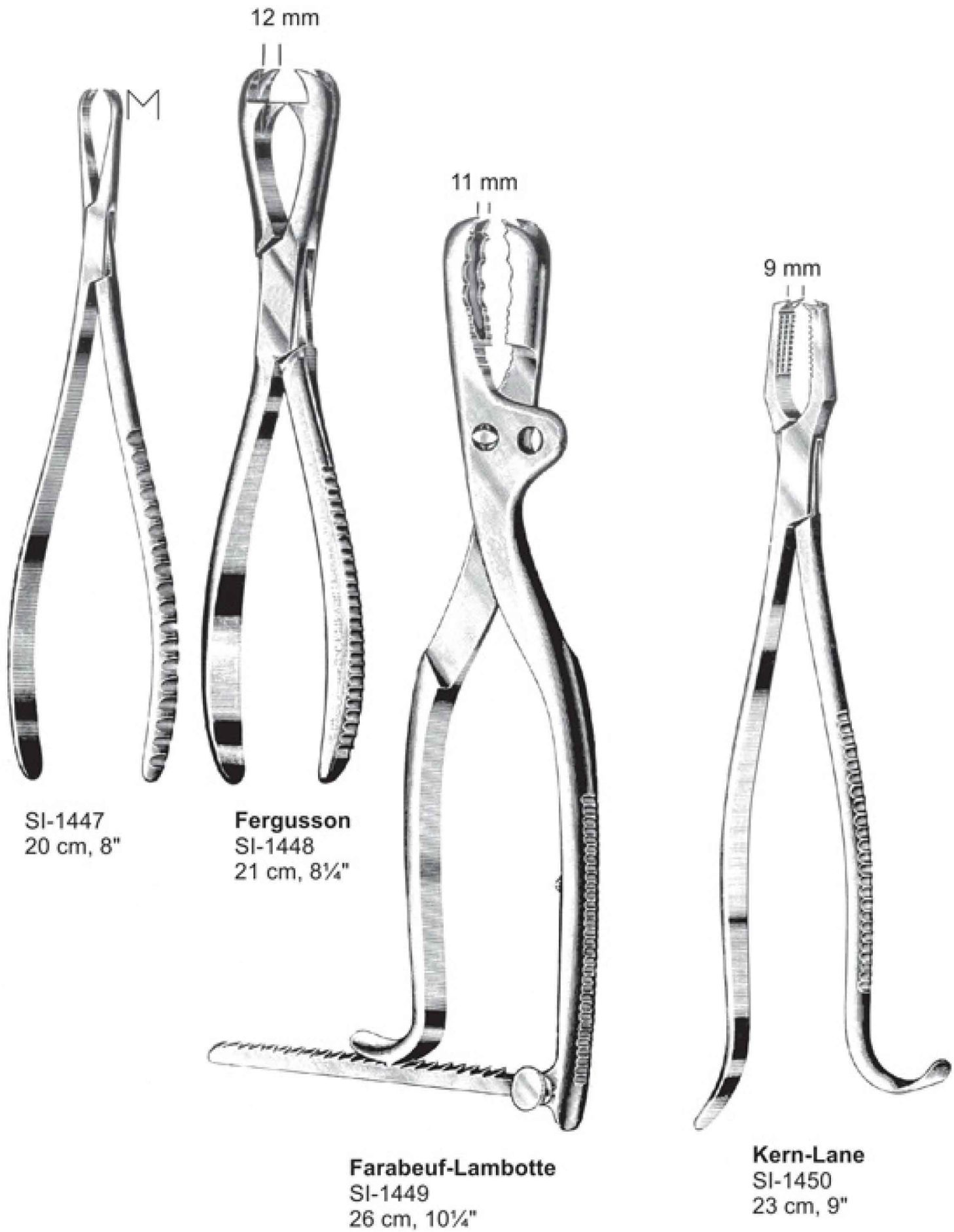

Bone Holding Forceps

Forceps for Repositing Small Fragments



SI-1451
13½ cm, 5¼"

5 mm 2,5 mm



1/1



Reill
SI-1452
17 cm, 6¾"

1/2



Verbrugge
SI-1453
17½ cm, 7"
Extra klein, small
petit model

1/2

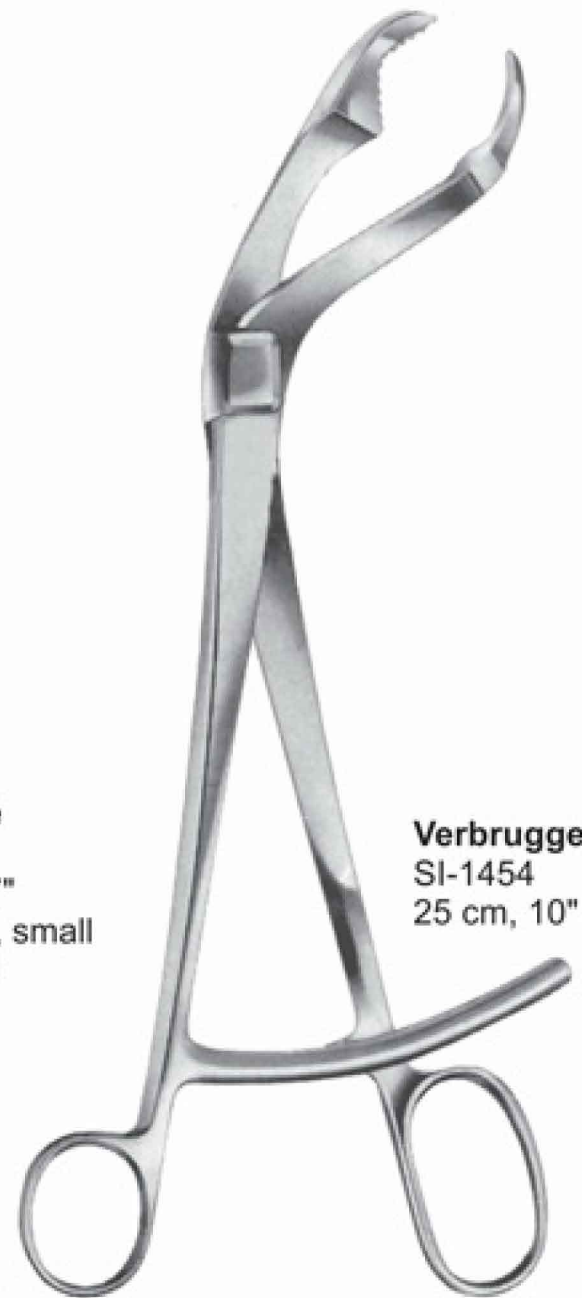

Verbrugge
SI-1454
25 cm, 10"

Bone Ronguers

Bone Cutting Forceps Curved on flat



Luer-Friedmann
SI-1455
14 cm, 5½"



Luer
SI-1456
15½ cm, 6 1/8"



Luer
SI-1457
17 cm, 6¾"



Luer
SI-1458
17 cm, 6¾"



Stille-Ruskin
SI-1459
23 cm, 9"

Towel Clamps - Forceps



Towel clamps

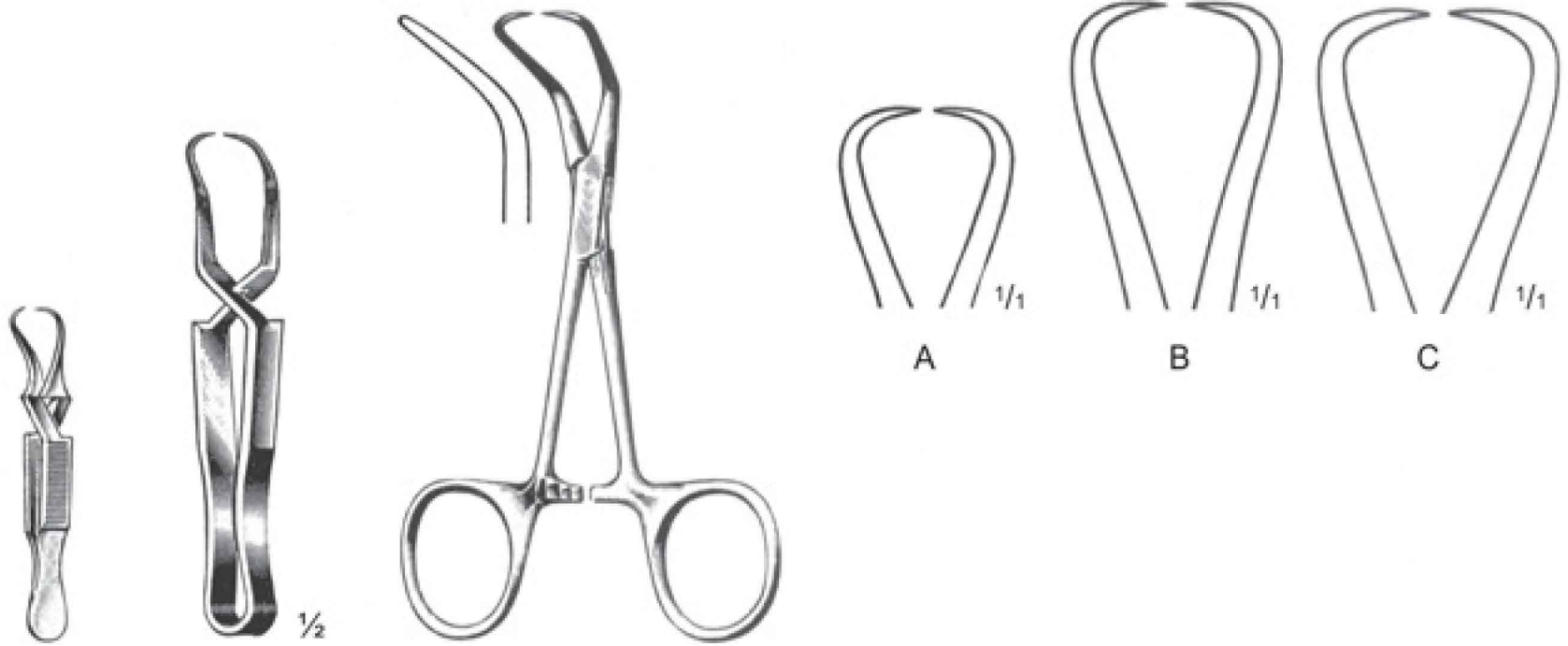

SI-1460
5½ cm, 2¼"

Schaedel
SI-1461
9 cm, 3½"
Curved

Backhaus Towel
SI-1462 9 cm, 3½"
SI-1463 11 cm, 4¼"
SI-1464 13 cm, 5¼"

Forceps

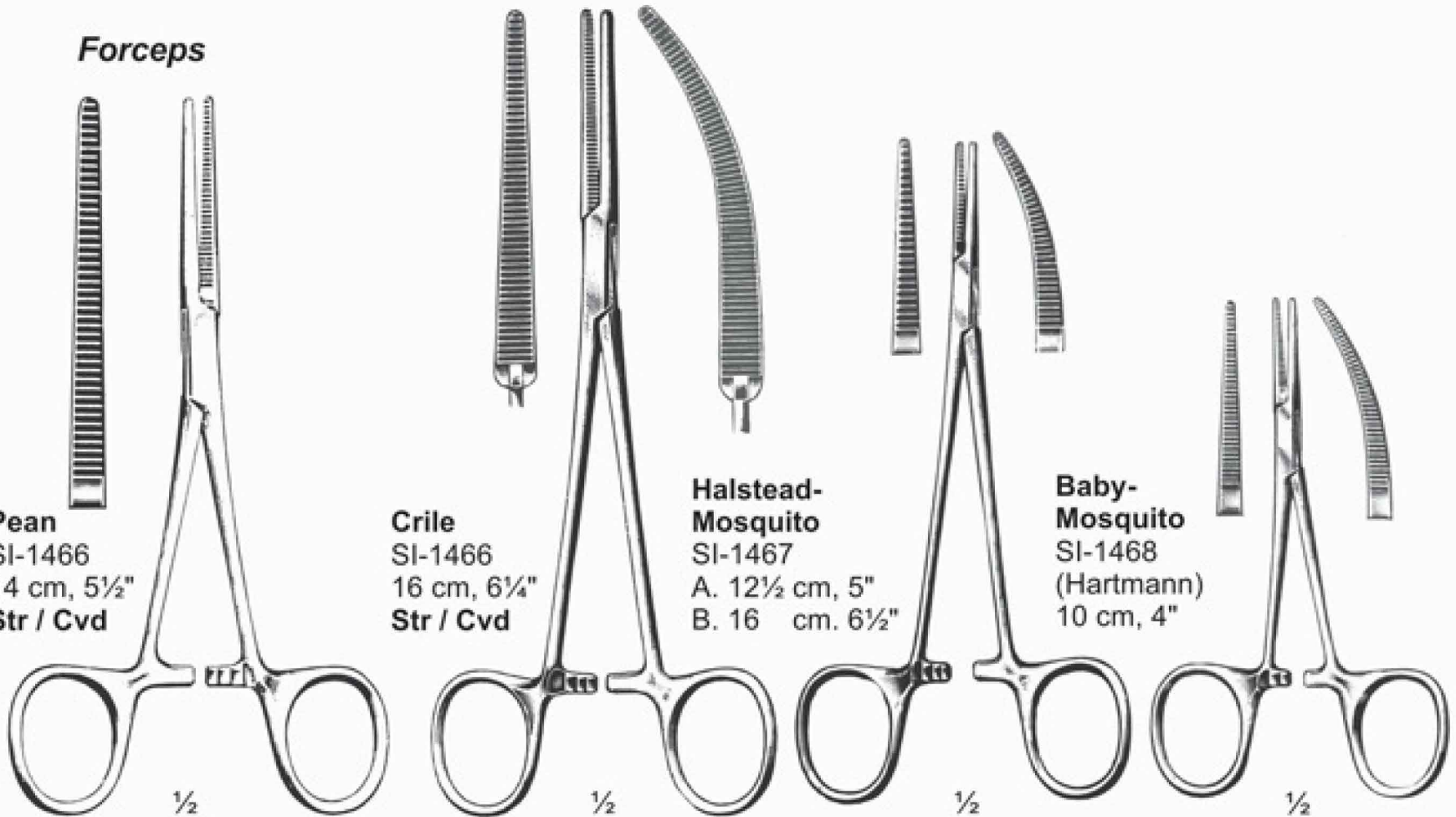

Pean
SI-1466
14 cm, 5½"
Str / Cvd

Crile
SI-1466
16 cm, 6¼"
Str / Cvd

Halstead-Mosquito
SI-1467
A. 12½ cm, 5"
B. 16 cm, 6½"

Baby-Mosquito
SI-1468
(Hartmann)
10 cm, 4"

Note: All other type of forceps available on demand, kindly write us for our surgical instruments catalogue

Retractors

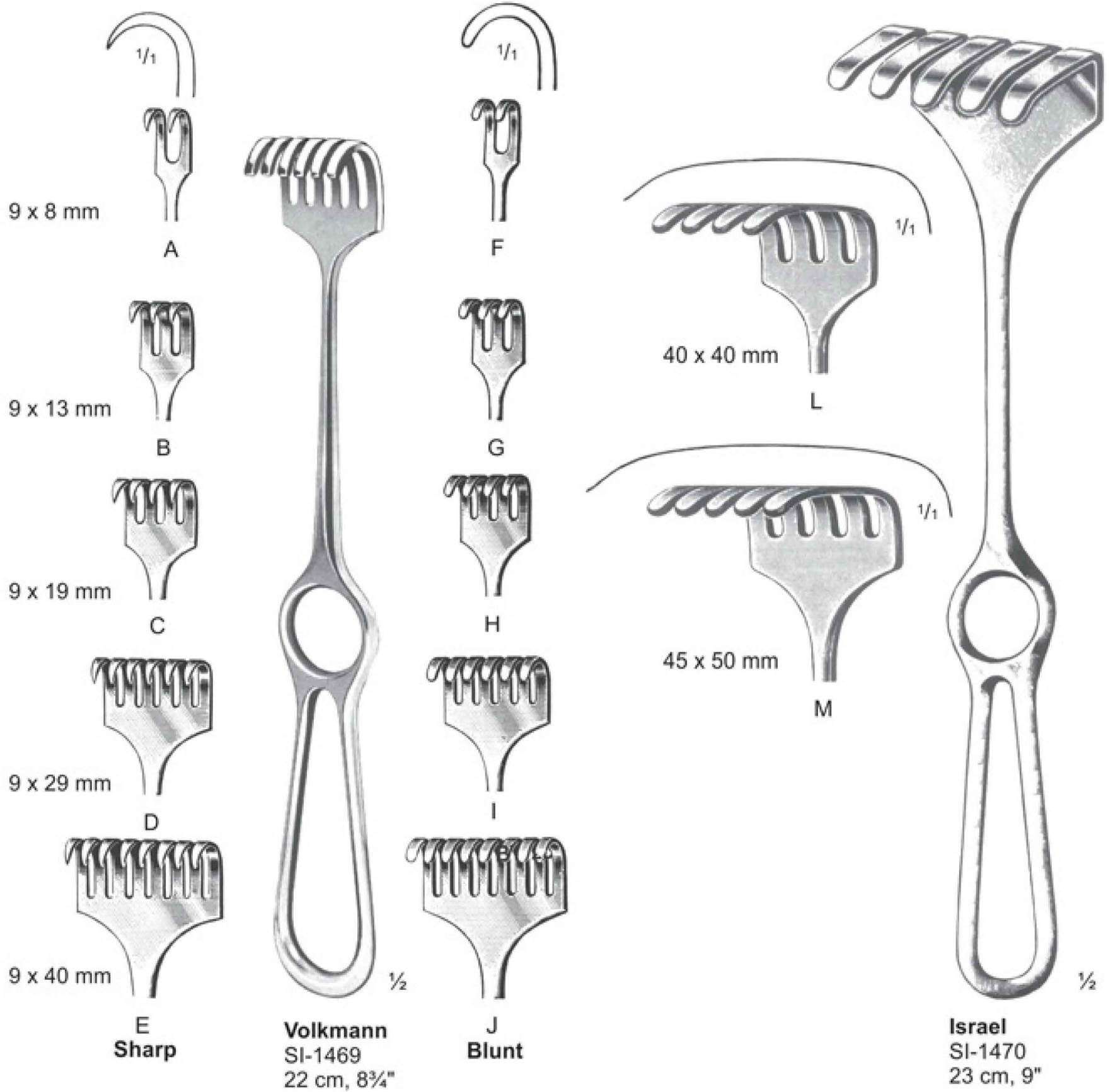

Retractors

Vein Retractors

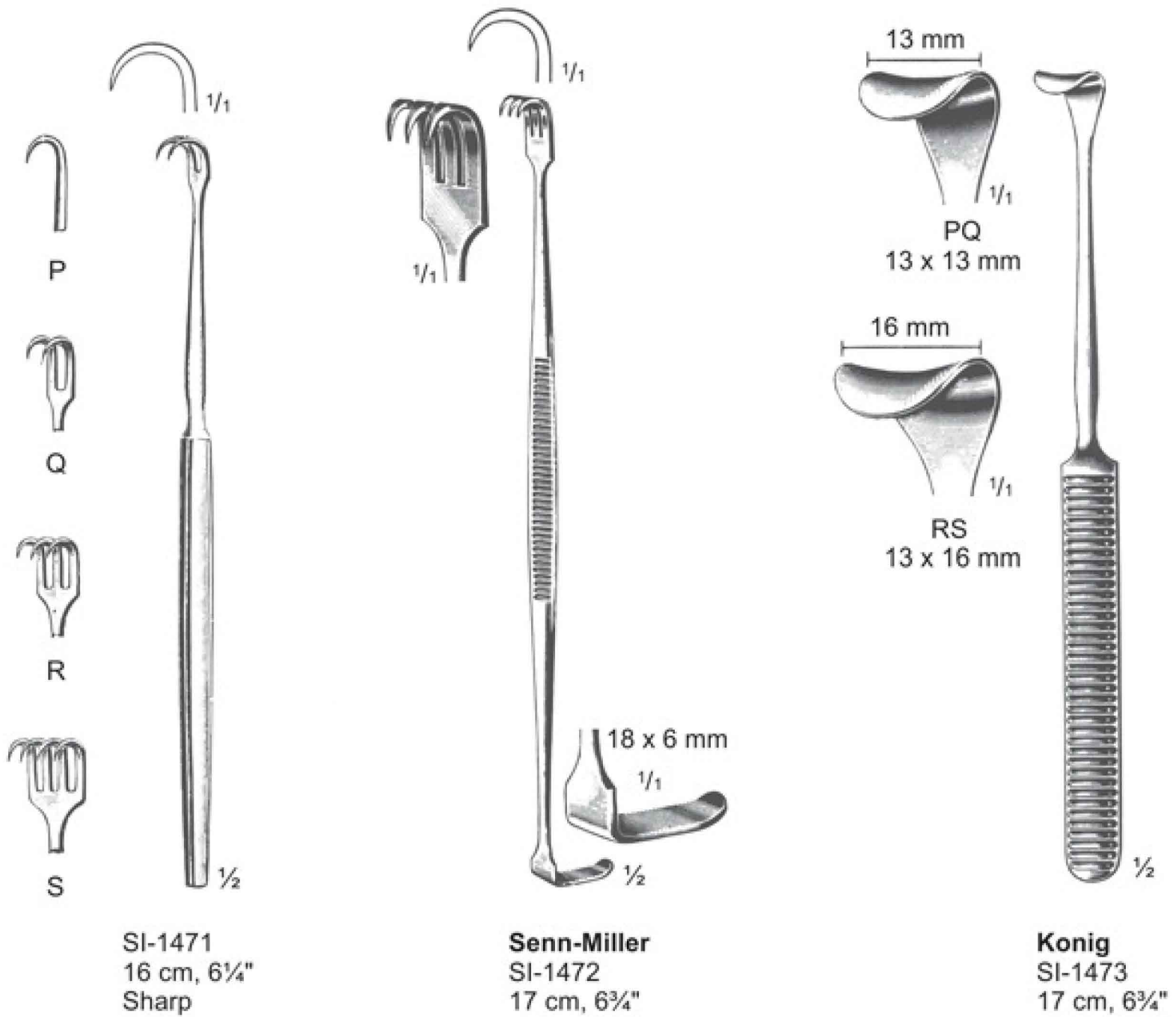

Retractors

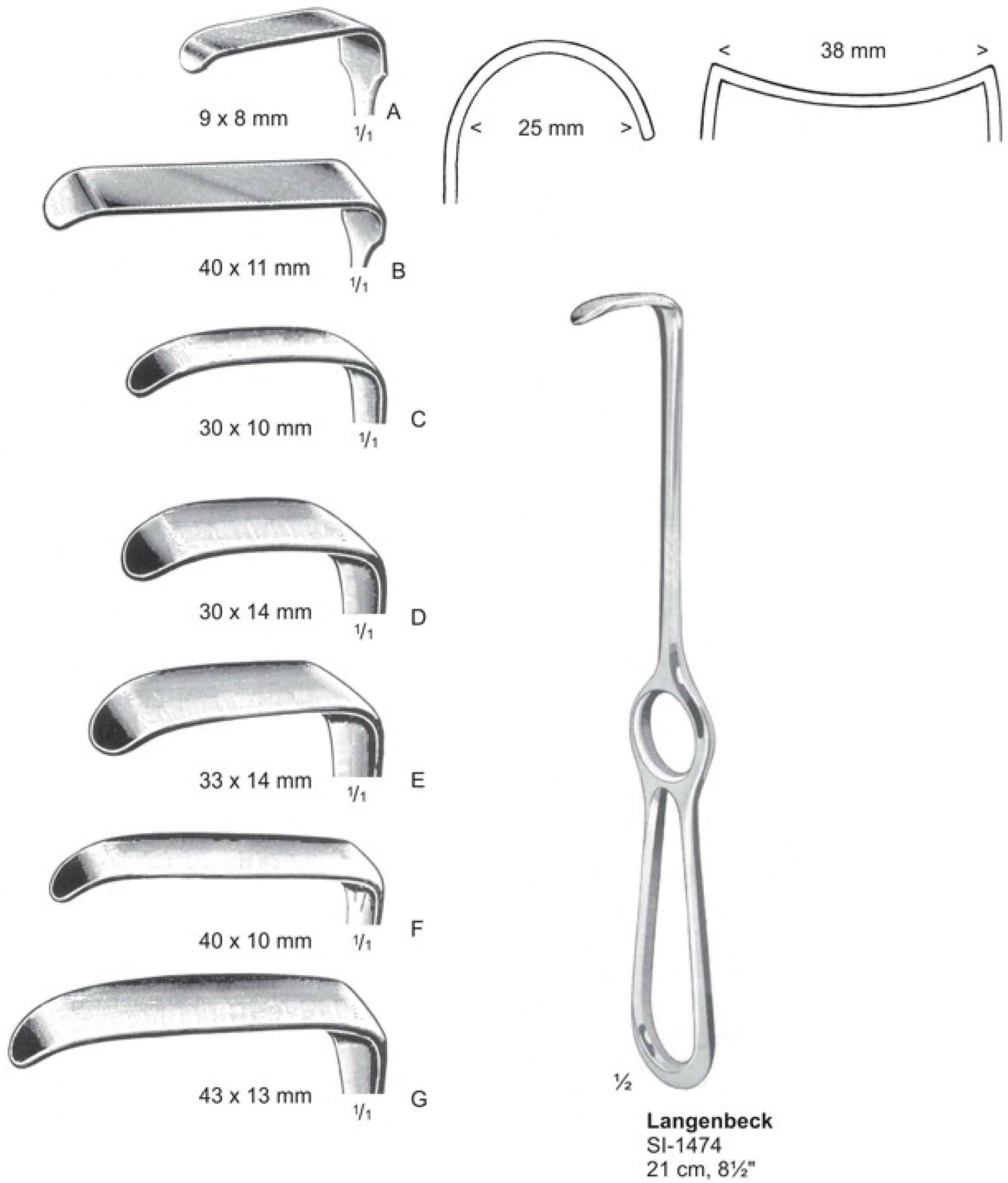

Retractors

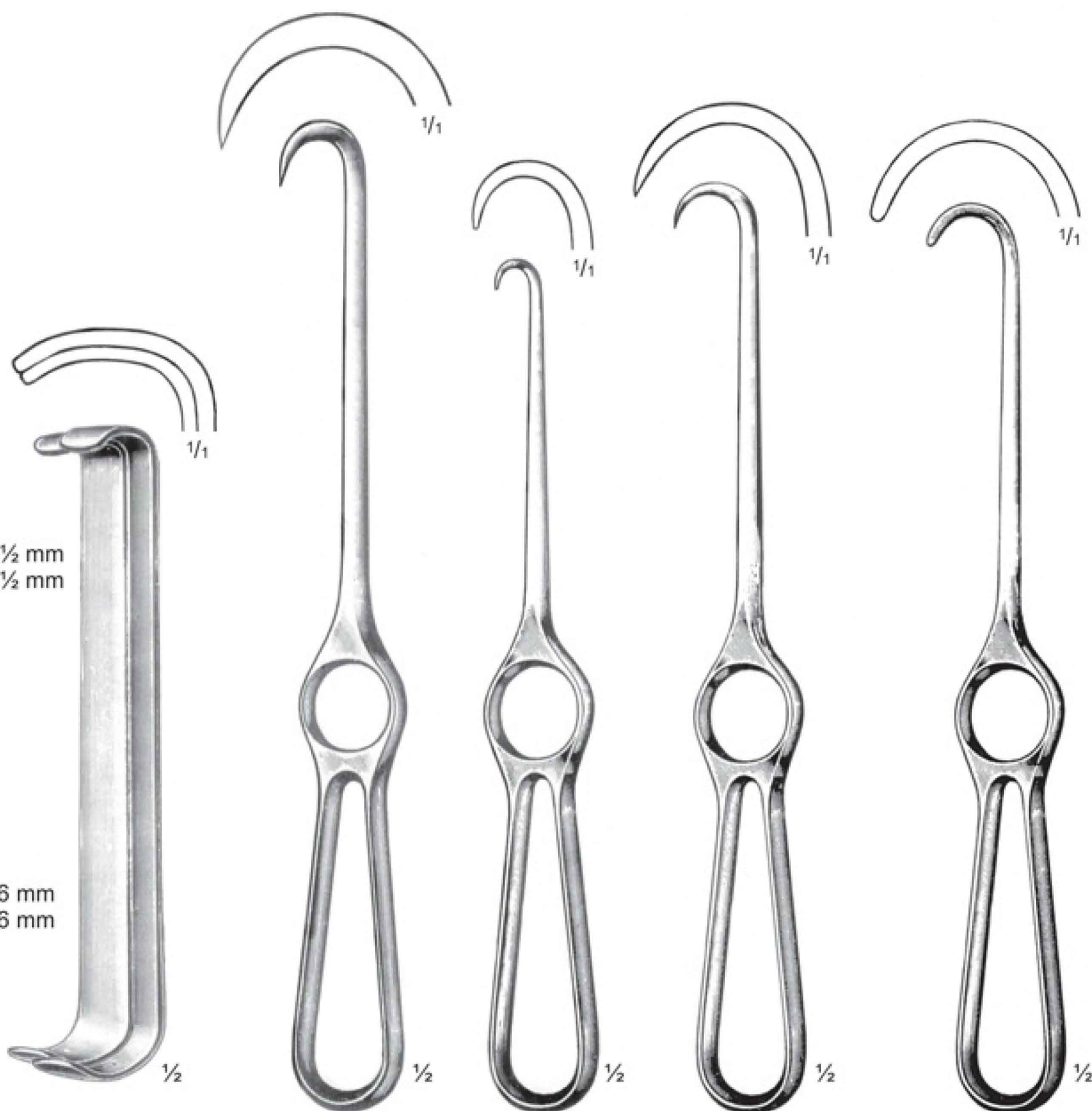

25 x 12½ mm
20 x 12½ mm

30 x 16 mm
35 x 16 mm

Collin
SI-1475
16½ cm, 6½"
Set of Two

SI-1476
24½ cm, 9¾"
Sharp

Kocher
SI-1477
22 cm, 8¾"
Sharp

Volkmann
SI-1478
22 cm, 8¾"
Sharp

Volkmann
SI-1479
22 cm, 8¾"
Blunt

Postmortem Saw Plaster Shear



Charriere	
cm	in.
A. 27	10½"
B. 30	12
C. 34	13½"

Charriere
SI-1480
Adjustable, with 3 Saw Blades,
3, 5 and 7 mm wide 2

Satterlee
SI-1481
31 cm, 12¼"

Bone Chisels & Gouges



Stille	
cm	in.
A. 23	9"
B. 26	10¼"
C. 37	14½"

Osteotomes	Chisels	Gouges	Stille	Stille	Stille
SI-1483	SI-1484	SI-1485	SI-1486	SI-1487	SI-1488
13.5 cm	13.5 cm	13.5 cm	20 cm	20 cm	20 cm
8 cm	8 cm	8 cm	10 cm	10 cm	10 cm
10 cm	10 cm	10 cm	15 cm	15 cm	15 cm
12 cm	12 cm	12 cm	20 cm	20 cm	20 cm
14 cm	14 cm	14 cm	25 cm	25 cm	25 cm
16 cm	16 cm	16 cm			

Post Mortem Knife



Cartilage Knife

Autopsy Knives



Virchow
SI-1489
22 cm, 8³/₄"
Stainless Handle

Virchow
SI-1490
24¹/₂ cm, 9¹/₂"
Stainless Handle

Virchow
SI-1491
24 cm, 9¹/₂"
Wooden Handle

Virchow
SI-1492
25¹/₂ cm, 10"
Wooden Handle

SI-1493
28 cm, 11"
Stainless Handle

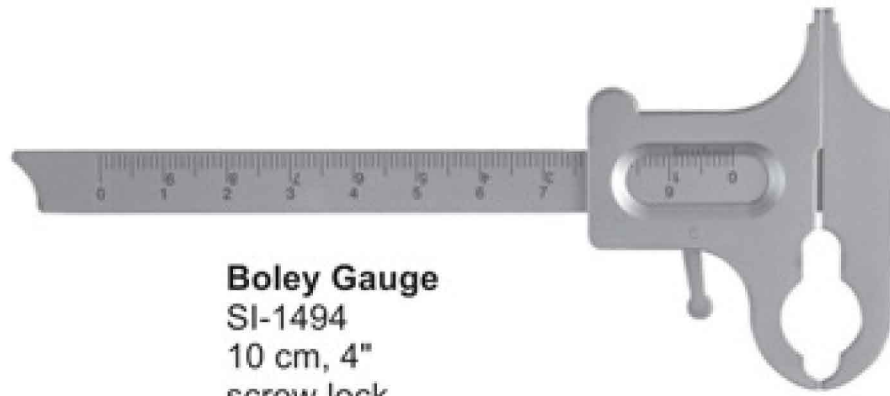

Boley Gauge
SI-1494
10 cm, 4"
screw lock.

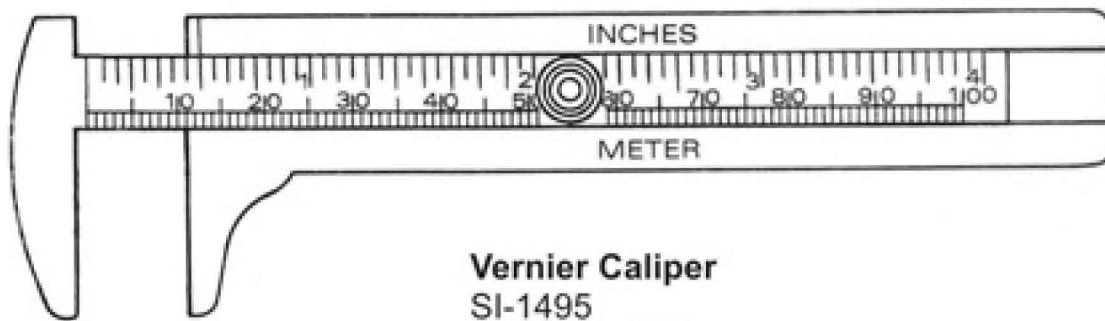

Vernier Caliper
SI-1495
11½ cm 4½"
High Polished



Veterinary Pal Caliper
SI-1496
10 cm, 4"



Iwanson Caliper
SI-1497
10 cm, 4"
All uses, for metal - for wax.

SI-1498

Ear Tagging



Ear Notcher
SI-1499
15cm Length
V-Cut Shape



Ear Notcher
SI-1500
15cm Length
Rectangular Shape



Ear Notcher
SI-1501
15cm Length
M-Cut Shape

Ear Notcher
SI-1502
15cm Length
Small V-Cut Shape



Ear Notcher
SI-1504
23cm Length
Cloverleaf Cut Shape

Ear Notcher
SI-1503
15cm Length
Round Shape



Ear Tagging Drench Pumps

Ear Notcher V-Cut (Aluminum)

- SI-1505 Small
- SI-1506 Medium with Plate
- SI-1507 Large with Plate



Ear Notcher Large

- SI-1508
- Triangular Shape

Ear Notcher Large

- SI-1509
- Oval Cut

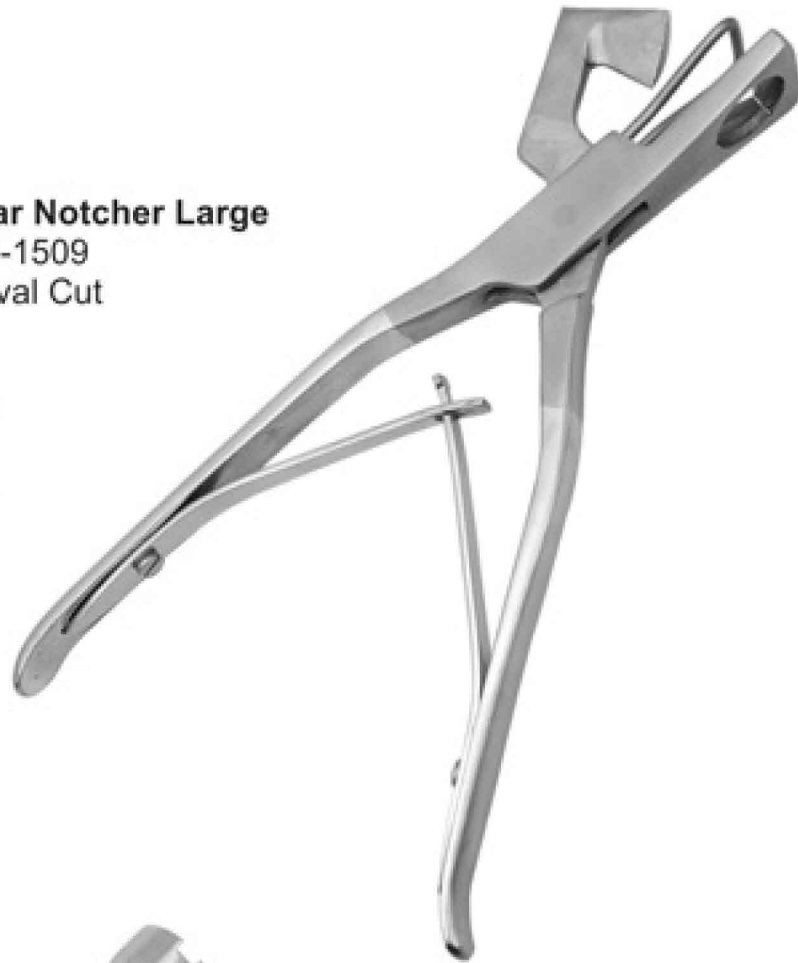

Drench Pump (Brass/NP)

- SI-1510
- Small size

- SI-1511
- Large size



Drench Pump (Brass/NP)

- SI-1512
- 39cm

Syringes & Trays



Glycerine Syringe
SI-1514 to SI-1517
With 3 rings, 1 cannula,
in packed in carton
Chrome Plated

A



Pomeroy Ears Syringe
SI-1518 to SI-1521
Chrome Plated

B



SI-1513
High polished

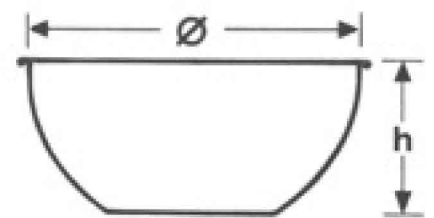

A

Available in sizes

2 oz	SI-1514
4 oz	SI-1515
6 oz	SI-1516
8 oz	SI-1517

B

Available in sizes

2 oz	SI-1518
4 oz	SI-1519
6 oz	SI-1520
8 oz	SI-1521

Sizes in mm Ø x h	Capacity 1	
110 x 50	0.375	SI-1522
120 x 57	0.45	SI-1523
140 x 65	0.7	SI-1524
160 x 75	1.1	SI-1525
180 x 85	1.5	SI-1526



Perforated trays
SI-1527
18 / 8, 505 x 305 x 60 mm
Stainless Steel

Trays & Jars



Trays

SI-360

Available in Size

- 7" x 5" SI-1528
- 6" x 8" SI-1529
- 8" x 10" SI-1530
- 12" x 14" SI-1531
- 16" x 8" SI-1532



SI-1533
220 x 70 mm

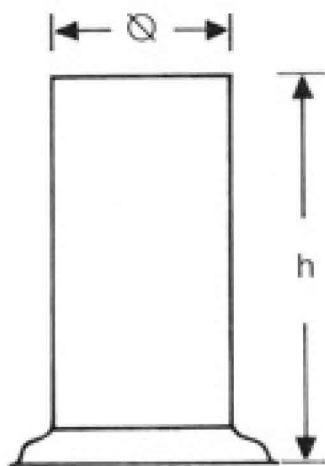

Jars

Ø x h
1" x 4"
2" x 7"
2" x 8"
4" x 8"



SI-1534
Jar without Lid



Lid Only

- 75 x 130 mm SI-1535
- 75 x 175 mm SI-1536
- 100 x 200 mm SI-1537

Dressing Containers Sterilizing Drums & Tray



Sterilizer Drums

SI-1538	3½" x 3½"
SI-1539	6" x 6"
SI-1540	7" x 7"
SI-1541	8" x 8"
SI-1542	9" x 9"
SI-1543	10" x 10"
SI-1544	12" x 12"
SI-1545	15" x 15"



Sterilizer Drums

SI-1546	125 x 120 mm
SI-1547	150 x 150 mm
SI-1548	165 x 150 mm
SI-1549	195 x 140 mm
SI-1550	245 x 160 mm
SI-1551	245 x 245 mm
SI-1552	290 x 160 mm
SI-1553	290 x 245 mm
SI-1554	340 x 250 mm
SI-1555	390 x 290 mm

Universal Trays, Instruments Storing Trays



	<u>l</u> x <u>b</u> x <u>h</u>
SI-1556	230 x 155 x 30 mm
SI-1557	300 x 175 x 30 mm
SI-1558	300 x 175 x 40 mm
SI-1559	350 x 240 x 36mm
SI-1560	400 x 300 x 50 mm

Highly Polished - Satin Finish

NOTE: Our factory can make any type of Hollow wares for your requirements, please write us for your demands

Standard Crimp Square Hole

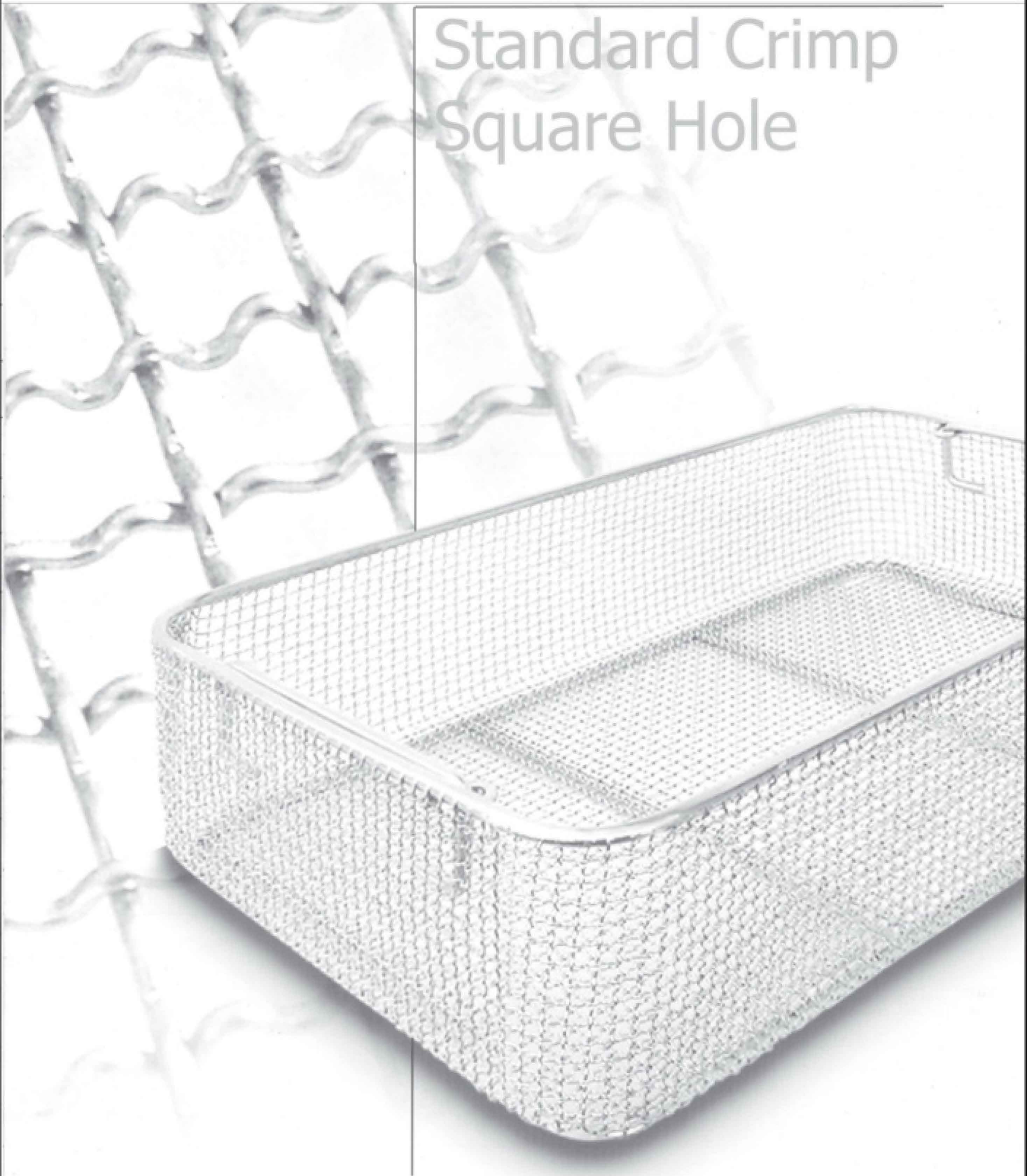

Sterilizing Baskets



Article No.	Dimension
SI-1561	540 x 255 x 30 mm
SI-1562	540 x 255 x 50 mm
SI-1563	540 x 255 x 70 mm
SI-1564	540 x 255 x 100 mm



Article No.	Dimension
SI-1565	485 x 255 x 30 mm
SI-1566	485 x 255 x 50 mm
SI-1567	485 x 255 x 70 mm
SI-1568	485 x 255 x 100 mm



Article No.	Dimension
SI-1569	405 x 255 x 30 mm
SI-1570	405 x 255 x 50 mm
SI-1571	405 x 255 x 70 mm
SI-1572	405 x 255 x 100 mm



Article No.	Dimension
SI-1573	255 x 245 x 30 mm
SI-1574	255 x 245 x 50 mm
SI-1575	255 x 245 x 70 mm
SI-1576	255 x 245 x 100 mm



Article No.	Dimension
SI-1577	300 x 230 x 50 mm
SI-1578	300 x 230 x 70 mm
SI-1579	300 x 230 x 100 mm

Standard Plain Square Hole



Sterilizing Baskets



Article No.	Dimension
SI-1580	540 x 255 x 30 mm
SI-1581	540 x 255 x 50 mm
SI-1582	540 x 255 x 70 mm
SI-1583	540 x 255 x 100 mm



Article No.	Dimension
SI-1584	485 x 255 x 30 mm
SI-1585	485 x 255 x 50 mm
SI-1586	485 x 255 x 70 mm
SI-1587	485 x 255 x 100 mm



Article No.	Dimension
SI-1588	405 x 255 x 30 mm
SI-1589	405 x 255 x 50 mm
SI-1590	405 x 255 x 70 mm
SI-1591	405 x 255 x 100 mm



Article No.	Dimension
SI-1592	255 x 245 x 30 mm
SI-1593	255 x 245 x 50 mm
SI-1594	255 x 245 x 70 mm
SI-1595	255 x 245 x 100 mm



Article No.	Dimension
SI-1596	260 x 115 x 40 mm
SI-1597	260 x 115 x 50 mm
SI-1598	260 x 115 x 70 mm

Standard Welded Square Hole



Sterilizing Baskets



Article No.	Dimension
SI-1599	540 x 255 x 30 mm
SI-1600	540 x 255 x 50 mm
SI-1601	540 x 255 x 70 mm
SI-1602	540 x 255 x 100 mm



Article No.	Dimension
SI-1603	485 x 255 x 30 mm
SI-1604	485 x 255 x 50 mm
SI-1605	485 x 255 x 70 mm
SI-1606	485 x 255 x 100 mm



Article No.	Dimension
SI-1607	405 x 255 x 30 mm
SI-1608	405 x 255 x 50 mm
SI-1609	405 x 255 x 70 mm
SI-1610	405 x 255 x 100 mm



Article No.	Dimension
SI-1611	255 x 245 x 30 mm
SI-1612	255 x 245 x 50 mm
SI-1613	255 x 245 x 70 mm
SI-1614	255 x 245 x 100 mm



Article No.	Dimension
SI-1615	510 x 240 mm
SI-1616	455 x 240 mm
SI-1617	375 x 240 mm
SI-1618	240 x 215 mm

Perforated Side Plate



Sterilizing Baskets



Article No.	Dimension
SI-1619	540 x 255 x 30 mm
SI-1620	540 x 255 x 50 mm
SI-1621	540 x 255 x 70 mm
SI-1622	540 x 255 x 100 mm



Article No.	Dimension
SI-1623	485 x 255 x 30 mm
SI-1624	485 x 255 x 50 mm
SI-1625	485 x 255 x 70 mm
SI-1626	485 x 255 x 100 mm



Article No.	Dimension
SI-1627	405 x 255 x 30 mm
SI-1628	405 x 255 x 50 mm
SI-1629	405 x 255 x 70 mm
SI-1630	405 x 255 x 100 mm



Article No.	Dimension
SI-1631	255 x 245 x 30 mm
SI-1632	255 x 245 x 50 mm
SI-1633	255 x 245 x 70 mm
SI-1634	255 x 245 x 100 mm



Article No.	Dimension
SI-1635	510 x 240 mm
SI-1636	455 x 240 mm
SI-1637	375 x 240 mm
SI-1638	240 x 215 mm

Standard with Lid



Sterilizing Baskets



Article No.	Dimension
SI-1639	460 x 320 x 80 mm
SI-1640	440 x 250 x 80 mm

Article No.	Dimension
SI-1641	440 x 250 x 40 mm
SI-1642	340 x 250 x 40 mm



Article No.	Dimension
SI-1643	272 x 172 x 30 mm
SI-1644	272 x 172 x 50 mm
SI-1645	272 x 172 x 70 mm
SI-1646	272 x 172 x 100 mm

Article No.	Dimension
SI-1647	260 x 115 x 40 mm
SI-1648	260 x 115 x 50 mm
SI-1649	260 x 115 x 70 mm
SI-1650	225 x 130 x 40 mm
SI-1651	200 x 75 x 40 mm
SI-1652	130 x 115 x 50 mm
SI-1653	130 x 115 x 70 mm



Equestrian Equipments (Bits)



SI-1654



SI-1655



SI-1656



SI-1657



SI-1658



SI-1659



SI-1660



SI-1661



SI-1662



SI-1663



SI-1664



SI-1665



SI-1666



SI-1667

Equestrian Equipments (Bits)



Equestrian Equipments (Bits)

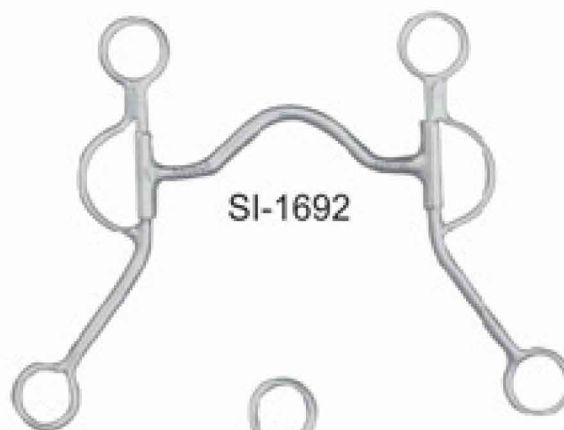
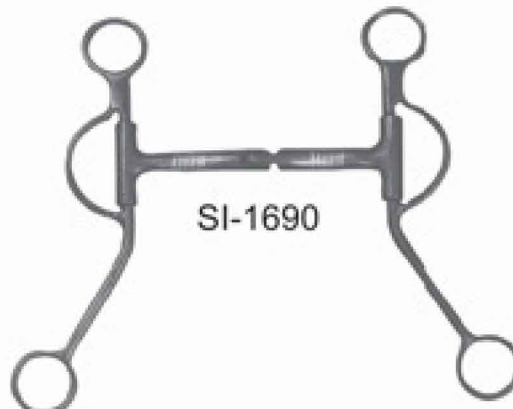
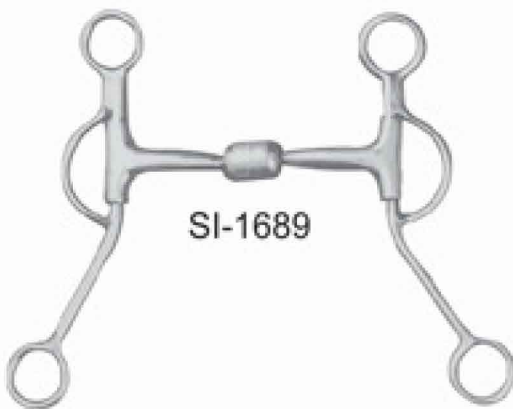
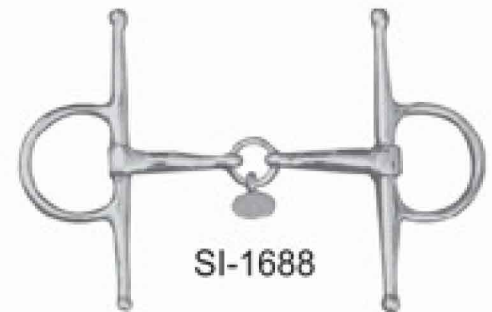

Equestrian Equipments (Bits)

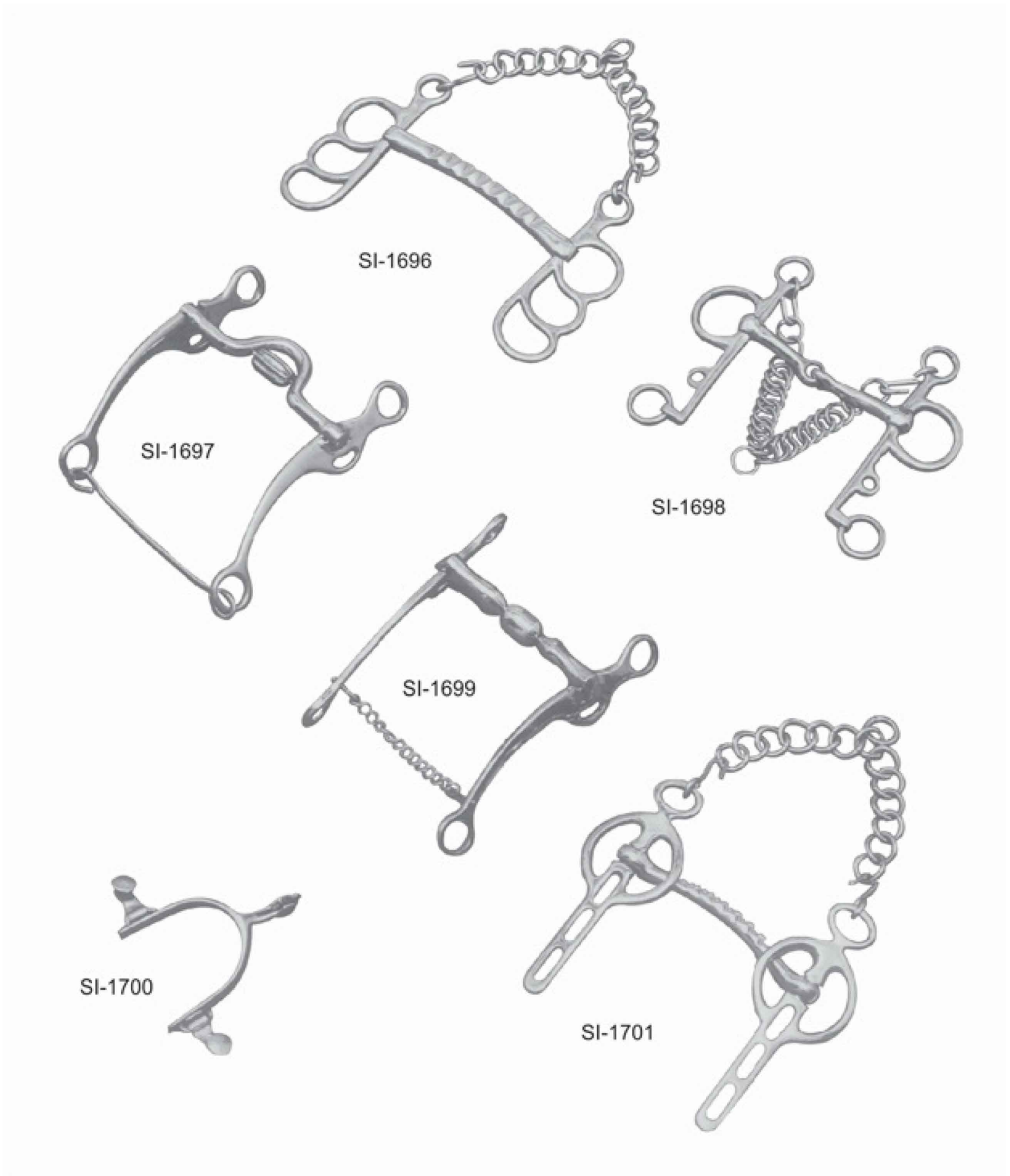

Equestrian Equipments (Stirrups)



SI-1702



SI-1703

SI-1704



SI-1705

SI-1706



SI-1707



SI-1708



SI-1709



SI-1710



SI-1711



SI-1712



SI-1713



VETERINARY INSTRUMENTS



Head Office

**Bazar Tiba Kakky Zayian Near Muqadas
Jewler 51310 SIALKOT Pakistan**

Ph: +92-52-4581064

Mob:+92-344-6008100

Email: info@faisalindustries.co.uk

www.faisalindustries.co.uk

UK Office

**24 HEACHAM CLOSE, LUTAN, BED-
FORDSHIRE. POST CODE: LU4 0YJ**

United Kingdom

Ph:+44-7429-1938-60